







-  Antal klättring 2
-  Antal lekpaneler 1
-  Antal tak 2
-  Antal rutschkanor 1
-  Antal torn 2



Den här kombinationsleken har två delar i en, en klätterdel med klättervägg och klätternät medan den andra har en trapp som leder upp till en plattform. Väl uppe finns en lekpanel och en rutschkana.

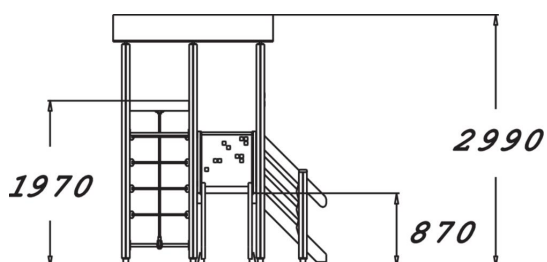
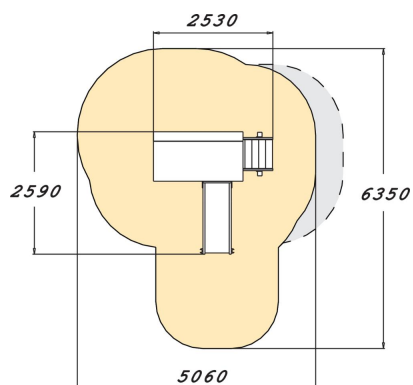

Åldersgrupp	1+
Antal användare	6
Längd, mm	2530
Bredd, mm	2590
Höjd mm	2990
Islagsyta M ²	23.2
Fallyta, M ²	25.4
Minimum utrymmeshöjd, mm	3030
Max fri fallhöjd, mm	1970
Säkerhetsstandard & certifikat	EN 1176-1, 3 TÜV
Monteringstid (1 person) tim	8
Monteringsalternativ	deep_mounting surface_mounting