

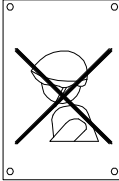

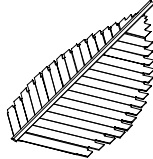

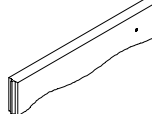

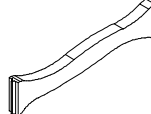

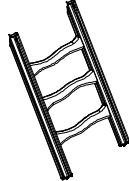

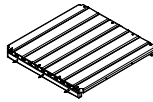
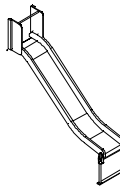

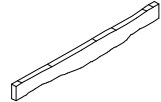
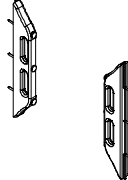

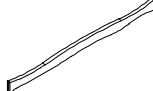
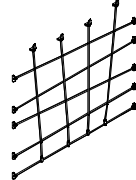
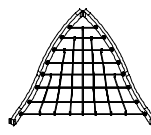
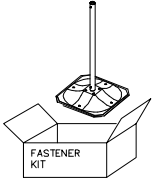
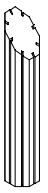

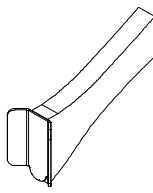
702286  65x65	PCS 1	702339  118x78	PCS 1	705203-001  1	PCS 1	705211-001  45x145x715	PCS 4	705214-001  45x145x724	PCS 1	705227-001  1	PCS 1
705236-001  93x93x3138	PCS 2	705238-001  93x93x2846	PCS 2	705258-001  1	PCS 1	705308-001  1	PCS 1	705429-001  140x140x2894	PCS 3	705431-001  68x260x2280	PCS 1
705506-001  1	PCS 1	705511  2	PCS 2	705804-001  45x145x2280	PCS 1	705927  1	PCS 1	705951-001  1	PCS 1	706542  FASTENER KIT	PCS 1
708575-001  140x140x800	PCS 1	711467  1	PCS 1	711514-001  5	PCS 5	711863  1	PCS 1	901902  2	PCS 2	901916  L 650	PCS 1
903093  Ø8x90	PCS 28	903112  L=750	PCS 4	905104  M10	PCS 56	907698-216  L 2054	PCS 1	909519  1	PCS 1	909521  6	PCS 6
980114  Ø4x20	PCS 8		PCS		PCS		PCS		PCS		PCS
	PCS		PCS		PCS		PCS		PCS		PCS

- EN/AS Impact Area 58 m²
- - - - Falling Space 60 m²
Max Falling Height 2490 mm

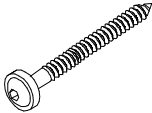

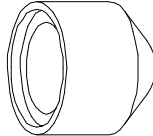

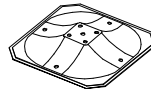
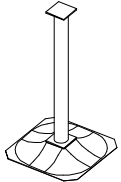
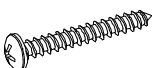
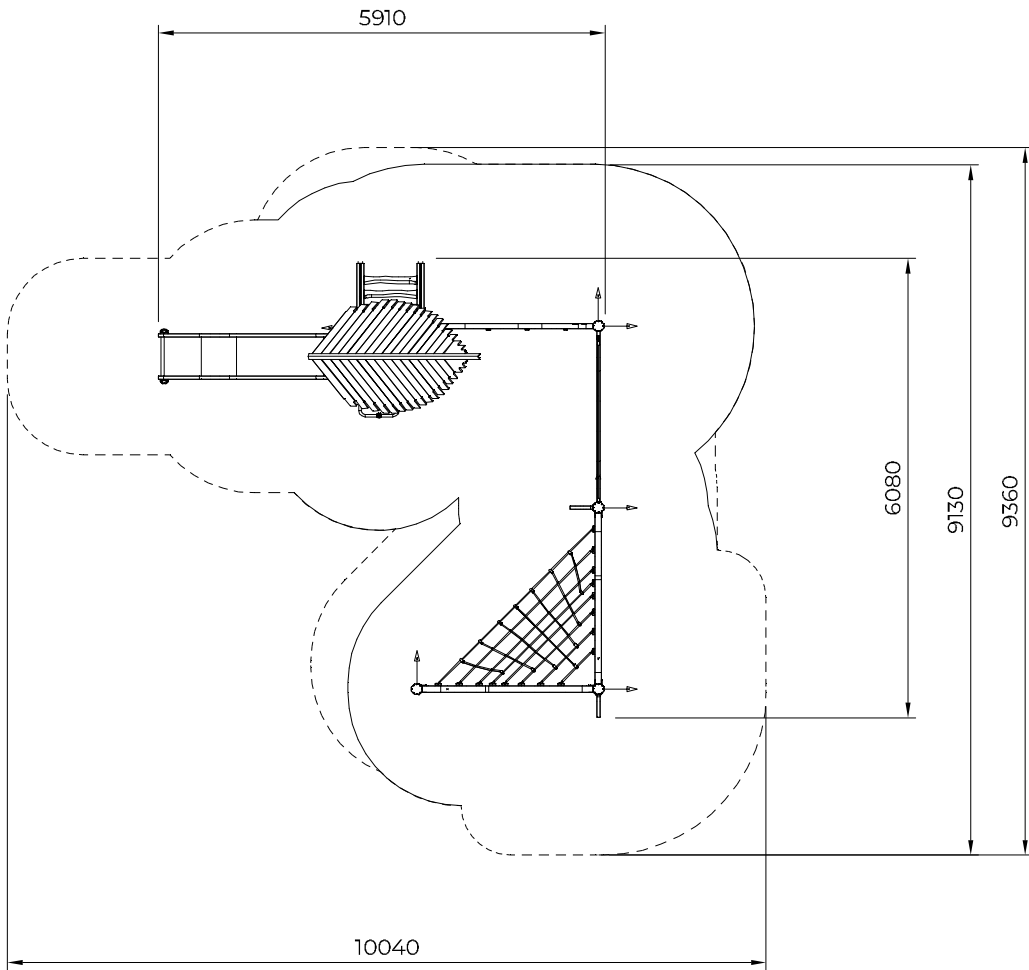
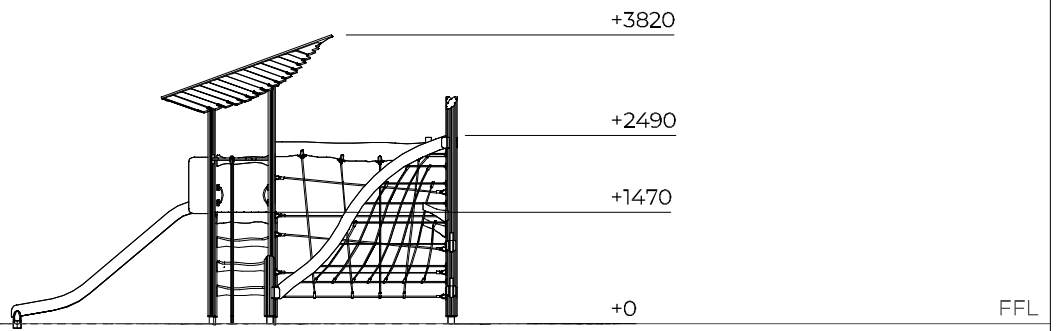
FFL = Finished Floor Level

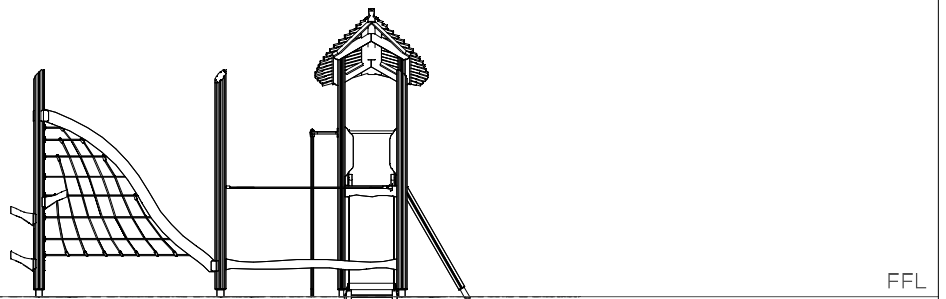

FFL = Finished Floor Level

