











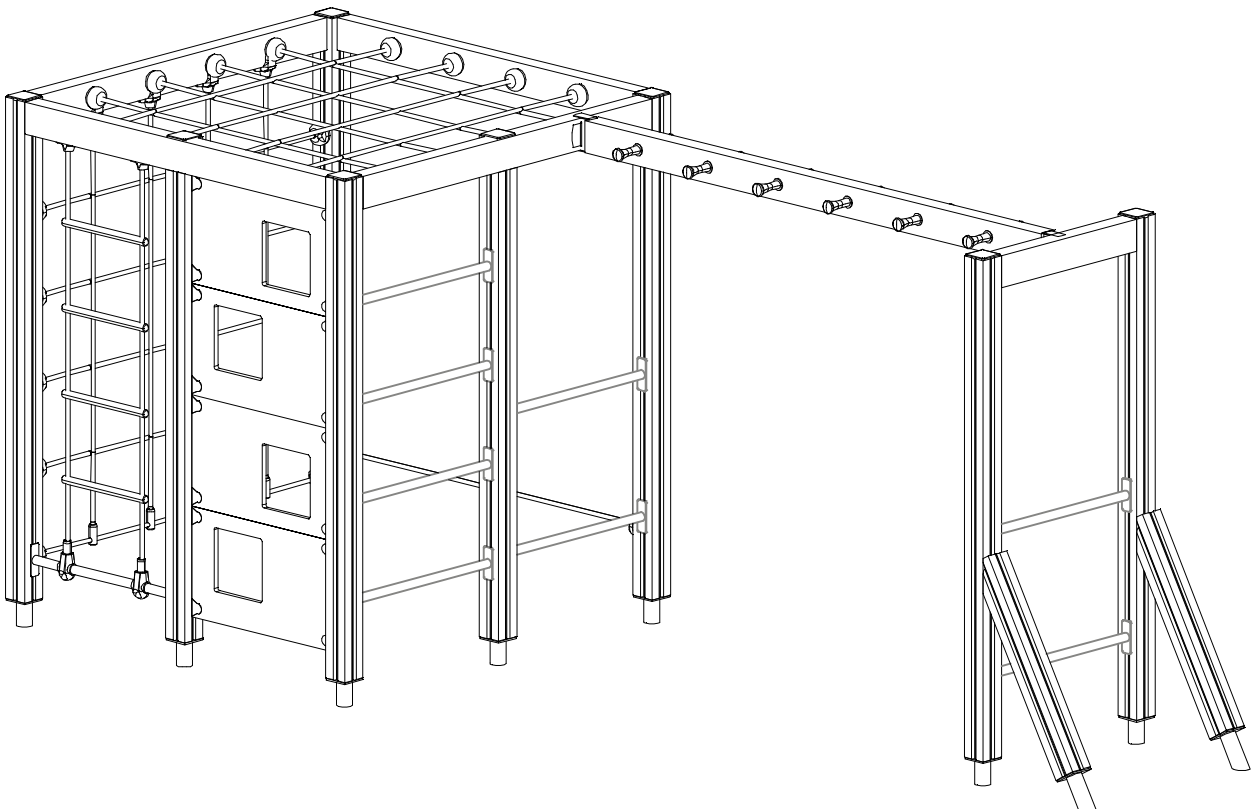



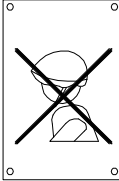
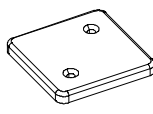
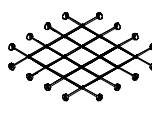

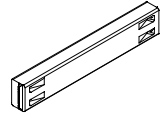
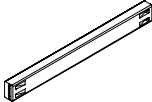
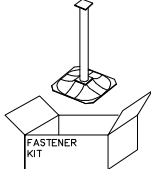
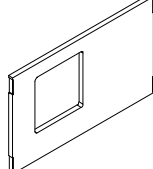
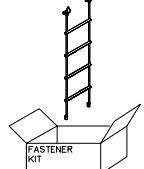
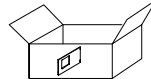
FINNO

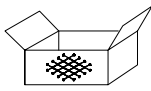
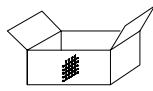
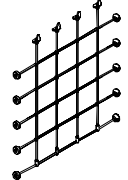
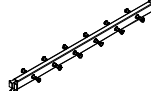
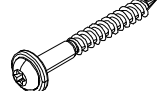
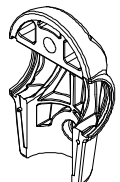
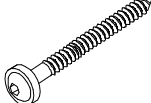
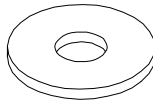
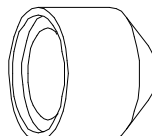
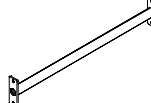
AENNUSOHJE
MONTERINGSANSVISNING
INSTALLATION INSTRUCTION
AUFBAUANLEITUNG
NOTICE D'INSTALLATION

DATE: 22.10.2025

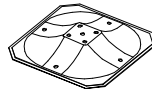
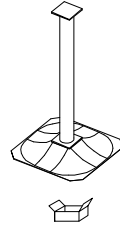
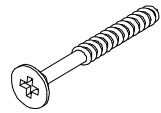
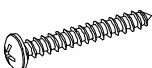
Q19394



702286	PCS	702339	PCS	706481-703	PCS	706485-305	PCS	706511	PCS	706512	PCS
	1		1		8		1		6		1
65x65		118x78		93x93x10		1555x1555		93x93x1870		70x120x704	
706514	PCS	706531	PCS	706540-703	PCS	706546	PCS	706557	PCS	706780-305	PCS
	4		8		4		1		4		1
70x120x1504		FASTENER KIT		20x702x415		FASTENER KIT					
706905	PCS	706932	PCS	706934	PCS	706935-305	PCS	707290	PCS	900240	PCS
	2		1		1		1		1		36
93x93x1870						1505x1600		127x300x2355		Ø8x70	
901902	PCS	903093	PCS	905051	PCS	905104	PCS	907694-216	PCS	909231	PCS
	4		24		4		8		9		2
30.7x60.9x100		Ø8x90		Ø24/8.5		M10		L 704		8x130	
909233	PCS	909256	PCS	909511	PCS	909519	PCS	909521	PCS	980107	PCS
	2		12		8		8		2		16
8x100		Ø16/8.4		90x90x650		50x380x380				Ø6x60	
980114	PCS	980128	PCS	P00109	PCS	P19535-305	PCS		PCS		PCS
	8		12		2		1				
Ø4x20		Ø7x40		L 840		L 1505					
	PCS		PCS		PCS		PCS		PCS		PCS

- EN/AS Impact Area 32 m²
- - - - Falling Space 32 m²
Max Falling Height 1970 mm

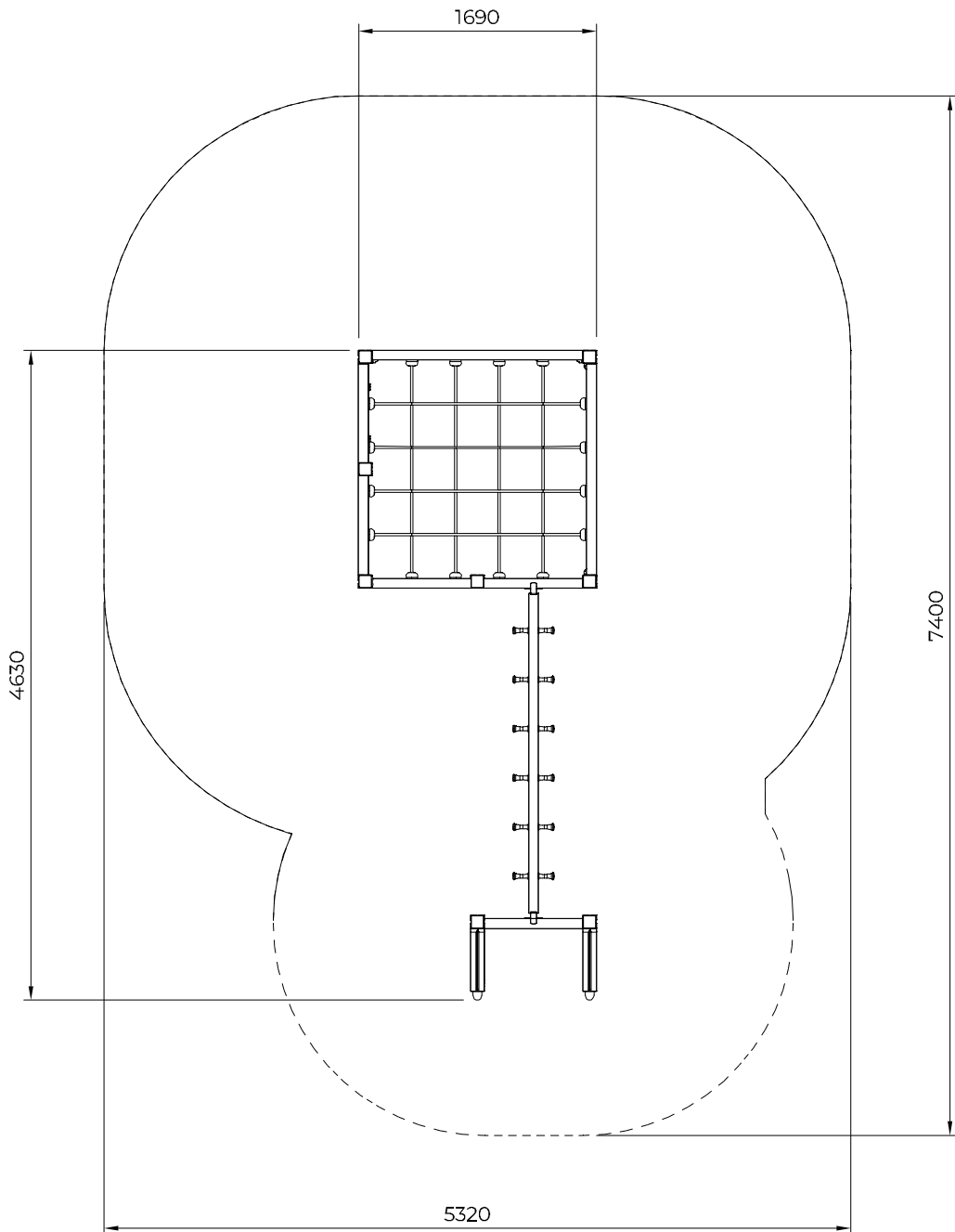

1:25

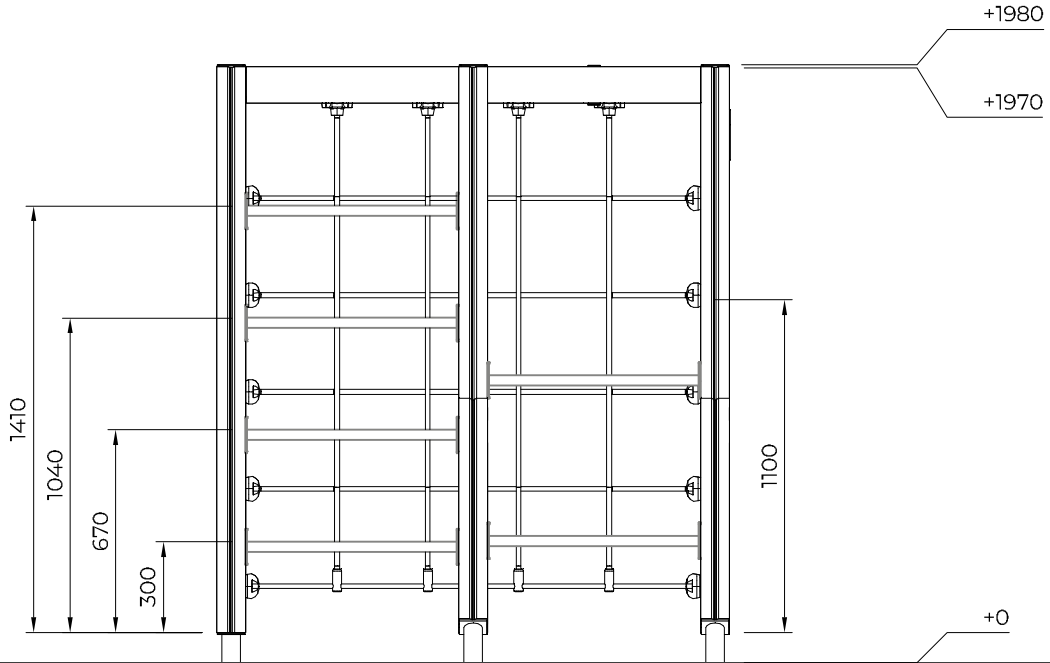

1:50

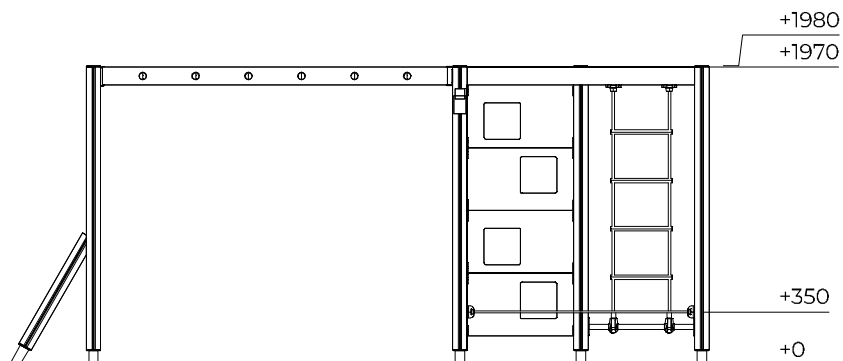

Max Falling Height.

