

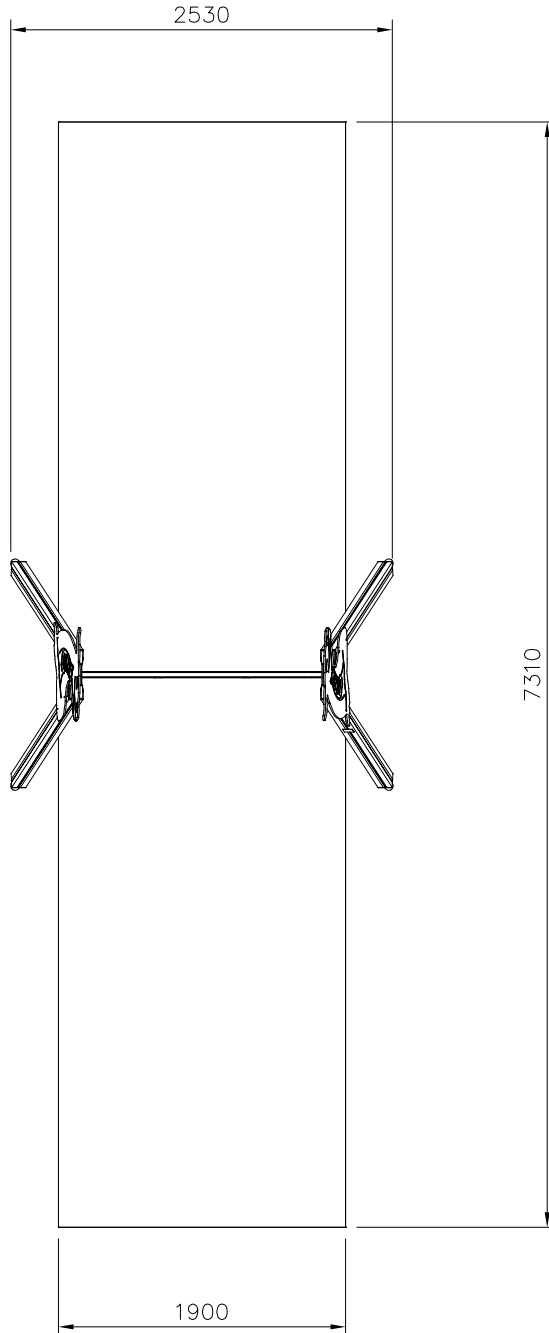

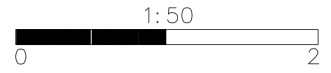

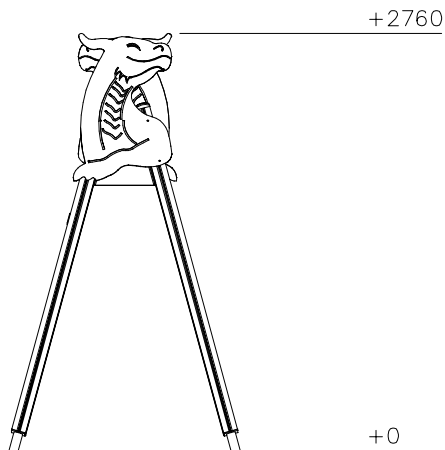

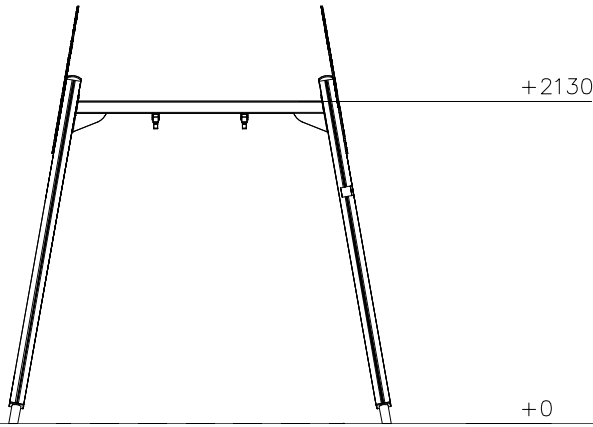

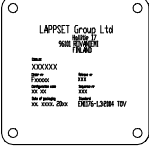

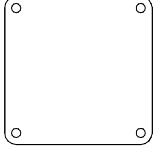
—— EN/AS Impact Area 13.9 m<sup>2</sup>  
- - - - Falling Space 13.9 m<sup>2</sup>  
Max Falling Height 1200 mm

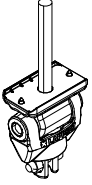
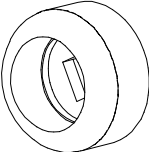
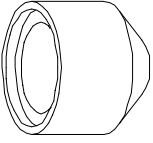
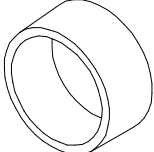
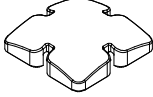
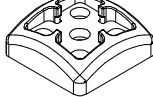
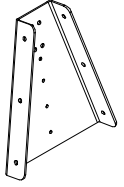
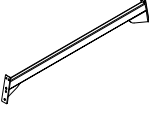

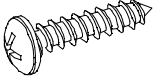

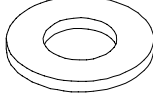
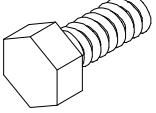
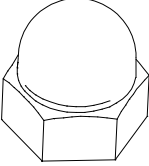
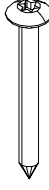
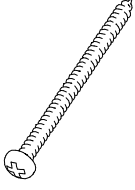
DATE: 12.2.2025

702286  90x50	PCS 1	706562  L2250	PCS 4	900965  M10	PCS 4	902487  65x65	PCS 1	903149  M12x30	PCS 4	904904  2	PCS 2
905090  Ø45	PCS 12	905104  M10	PCS 16	905115  Ø30	PCS 12	905138  4	PCS 4	905196  4	PCS 4	905991  2	PCS 2
906216  L1690	PCS 1	909347  M12x35	PCS 12	909506  Ø3.5x13	PCS 4	909511  L650	PCS 4	909638  Ø20/10.5	PCS 8	909639  M10x25	PCS 4
909644  M12	PCS 4	980123  Ø7x60	PCS 8	980131  Ø6x60	PCS 16	980154  Ø24/13	PCS 20	999561  GLUE 4101 ergo 10 g 10g	PCS 1	P18737  2	PCS 2
	PCS		PCS		PCS		PCS		PCS		PCS
	PCS		PCS		PCS		PCS		PCS		PCS
	PCS		PCS		PCS		PCS		PCS		PCS