

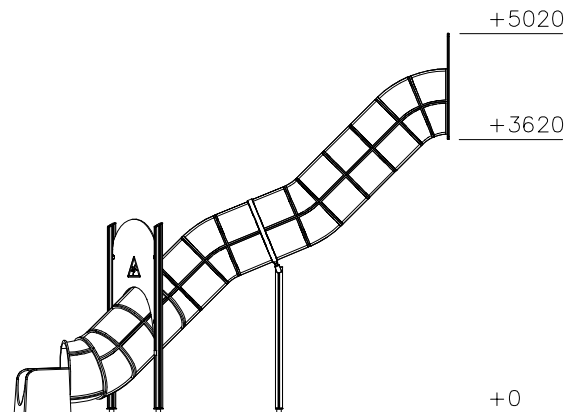

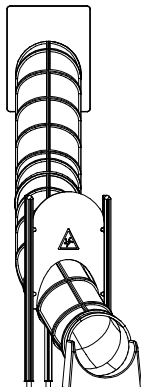

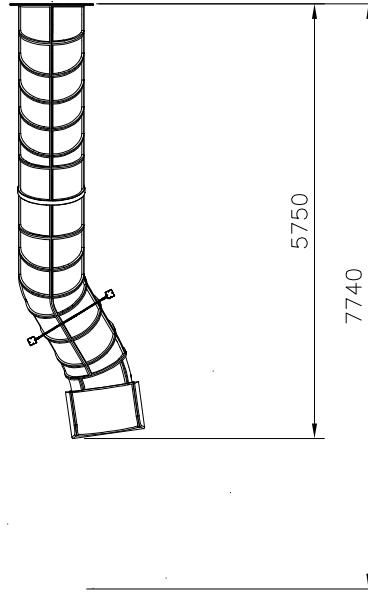





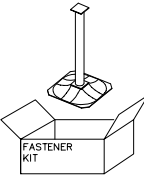
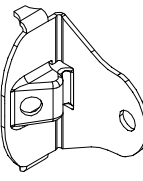
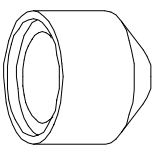
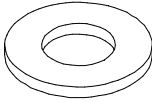

—— EN/AS Impact Area 7.4 m²
- - - - Falling Space 7,4 m²
Max Falling Height 1000 mm

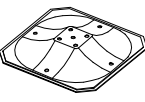
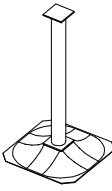
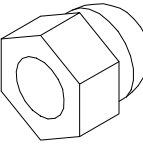

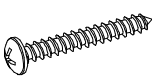
DATE: 11.2.2025

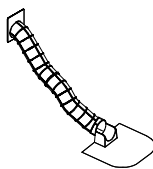
702286  65x65	PCS 1	705220-001  93x93x2446	PCS 2	706511  93x93x1870	PCS 1	706531  FASTENER KIT	PCS 1	903176 	PCS 4	905104  M10	PCS 8
909256  Ø16/8.4x1.6	PCS 4	909511  90x90x650	PCS 1	909519  50x380x380	PCS 1	909521  FASTENER KIT	PCS 2	909633  M8	PCS 4	909852  M8x30	PCS 4
980114  Ø4x20	PCS 4	980123  Ø7x60	PCS 4	A11174  +3750 Y/T	PCS 1	P06176  15x900x1100	PCS 1		PCS		PCS
	PCS		PCS		PCS		PCS		PCS		PCS
	PCS		PCS		PCS		PCS		PCS		PCS
	PCS		PCS		PCS		PCS		PCS		PCS
	PCS		PCS		PCS		PCS		PCS		PCS