

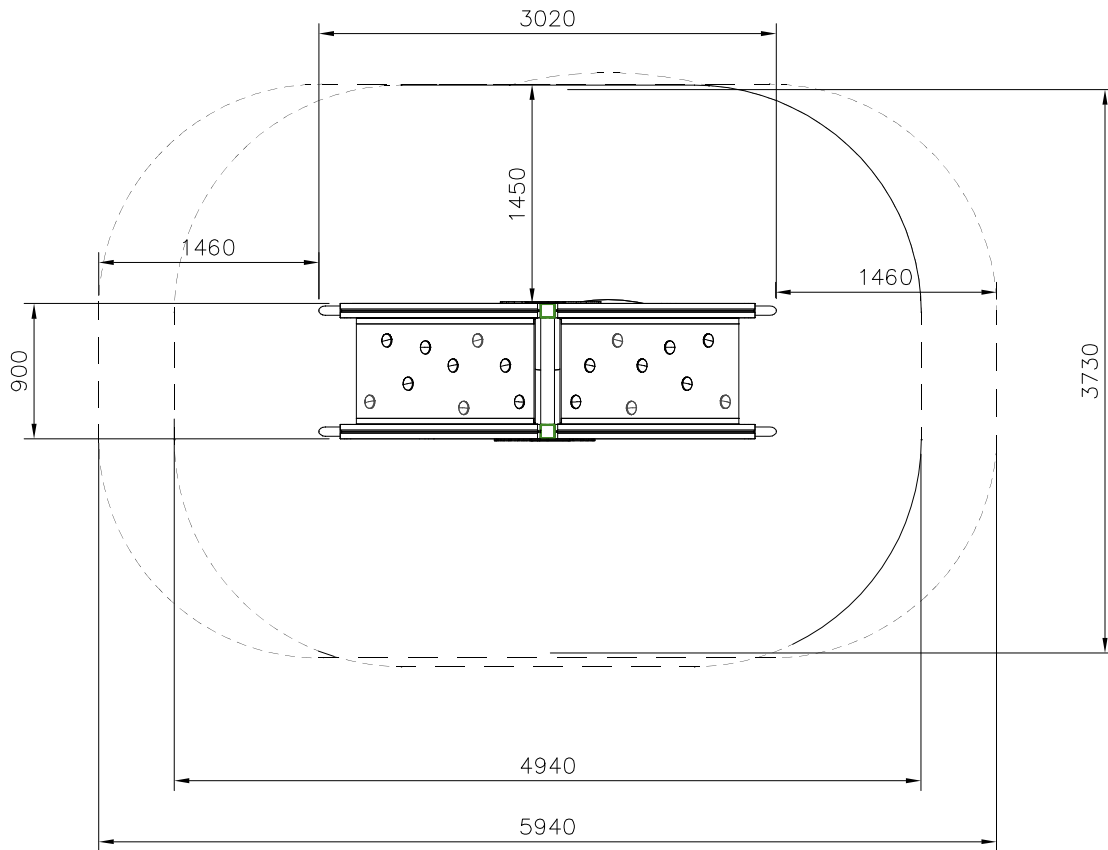

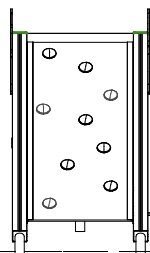

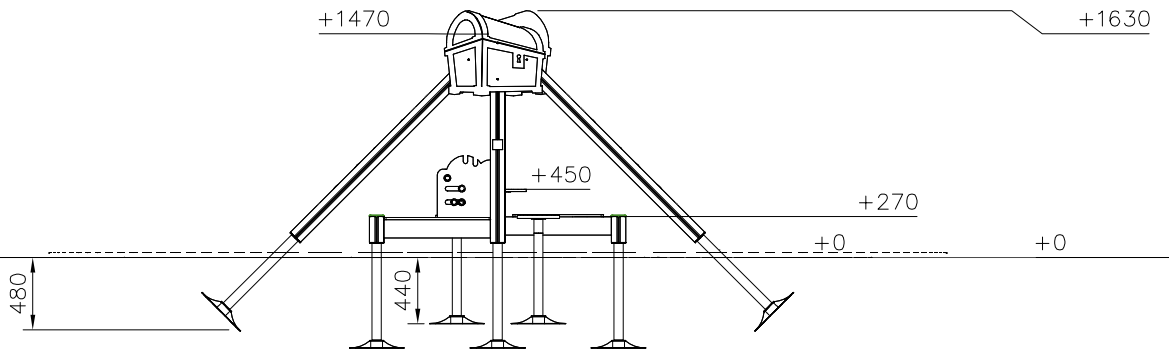

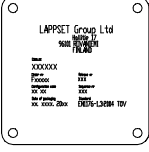

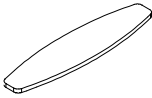
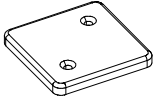
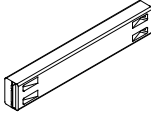
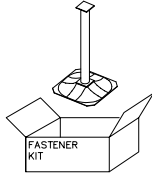
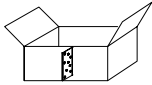

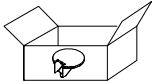
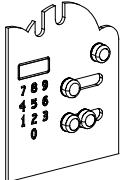
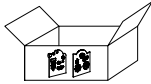
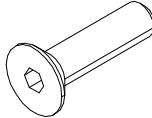
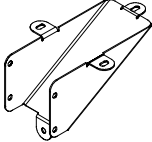
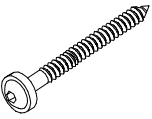
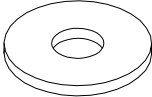
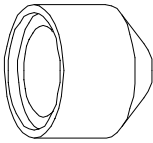
—— EN/AS Impact Area 17.1 m²
- - - - Falling Space 17.1 m²
Max Falling Height 1470 mm



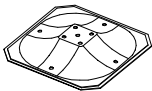

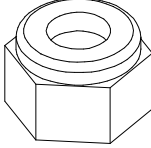
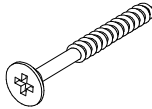
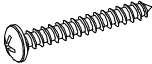
DATE: 26.2.2025

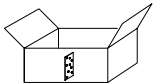
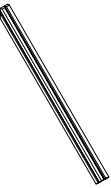
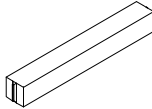
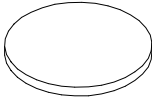
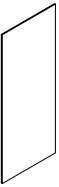
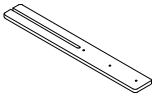
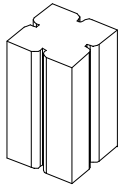
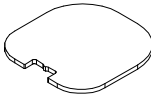
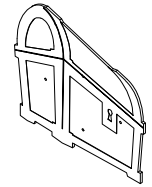
702286  65x65	PCS 1	706453-702  15x145x600	PCS 1	706481-707  83x83x10	PCS 4	706512  70x120x704	PCS 2	706531  FASTENER KIT	PCS 4	706609 	PCS 2
707420  93x93x1370	PCS 2	707729 	PCS 1	709372-702  423x351	PCS 1	709402  	PCS 1	901487  M10x40	PCS 8	902086  148x172x254	PCS 1
903093  Ø8x90	PCS 10	905051  Ø24/8.5	PCS 8	905104  M10	PCS 24	907770  2x35/40x1659	PCS 4	909231  8x130	PCS 4	909233  8x100	PCS 4
909511  90x90x650	PCS 4	909519 	PCS 4	909521  	PCS 6	909637  Ø20/10,5	PCS 8	980107  Ø6x60	PCS 8	980114  Ø4x20	PCS 4
980123  Ø7x40	PCS 12	980128 	PCS 3	A10394 	PCS 2	P07514 	PCS 4	P07698  L 707	PCS 1	P10201-702  Ø280	PCS 2
P11490-705  15x686x1660	PCS 2	P14556-704  10x93x702	PCS 1	P14992  93x93x170	PCS 2	P16873-702  15x385x385	PCS 1	P18757 	PCS 2		PCS
	PCS		PCS		PCS		PCS		PCS		PCS