

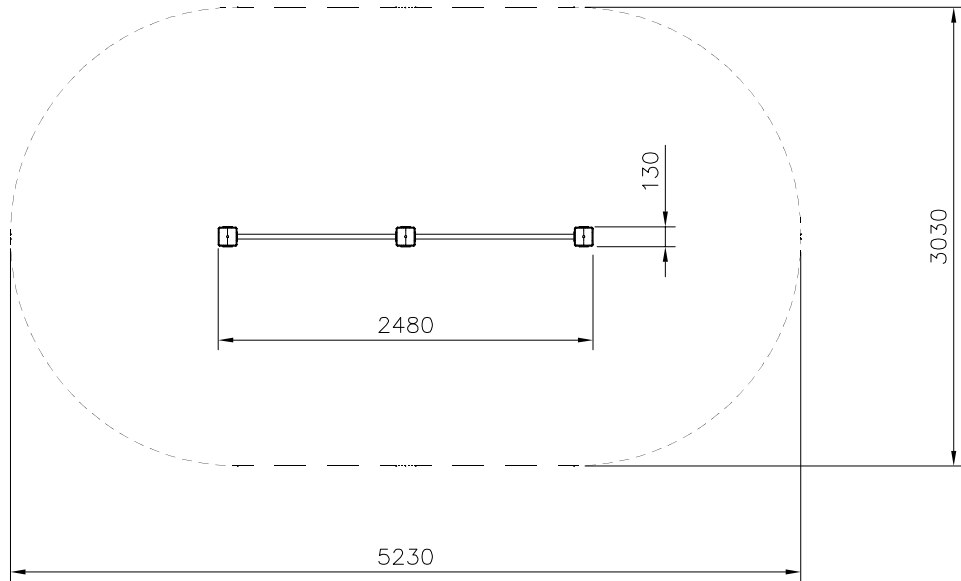

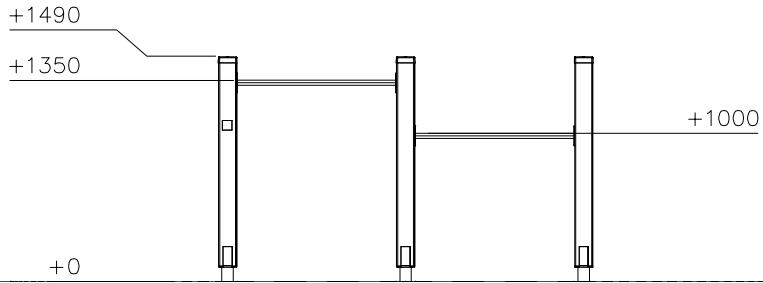

- EN/AS Impact Area 13.9 m²
- - - - Falling Space 13.9 m²
Max Falling Height 1350 mm

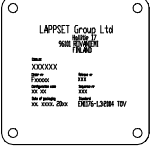

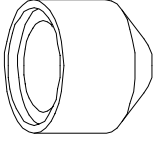
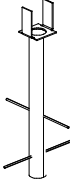
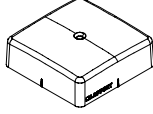
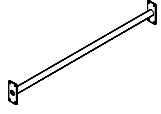
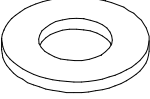
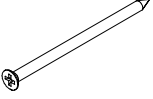
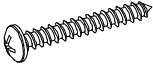

DATE: 2.4.2025

702286  65x65	PCS 1	704946  118x118x1350	PCS 3	905104  M10	PCS 12	905761  120x120x700	PCS 3	905830  123x123x40	PCS 3	905838-216  L 1060	PCS 2
909256  Ø16/8.4	PCS 16	980104  Ø5x90	PCS 3	980114  Ø4x20	PCS 4	980123  Ø7x60	PCS 28		PCS		PCS
	PCS		PCS		PCS		PCS		PCS		PCS
	PCS		PCS		PCS		PCS		PCS		PCS
	PCS		PCS		PCS		PCS		PCS		PCS
	PCS		PCS		PCS		PCS		PCS		PCS
	PCS		PCS		PCS		PCS		PCS		PCS