

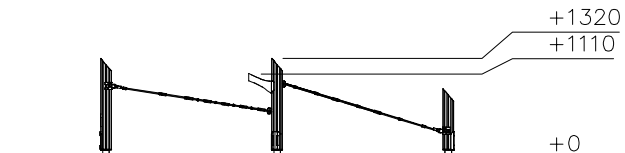

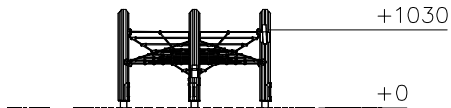

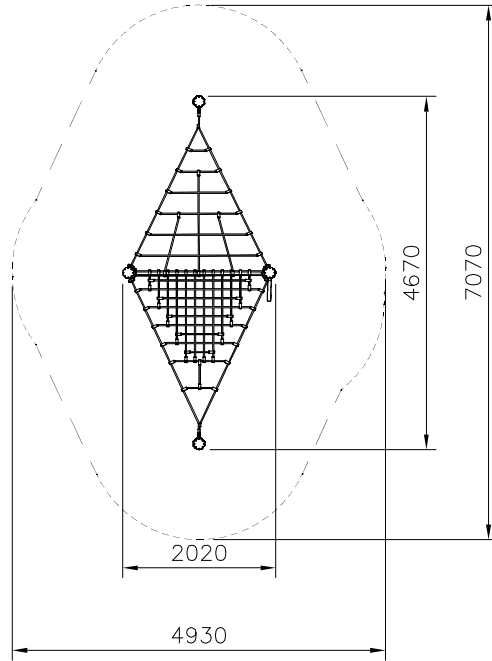

—— EN/AS Impact Area 24.6 m²
 - - - - Falling Space 24.6 m²
 Max Falling Height 1110 mm

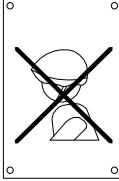

DATE: 27.3.2025

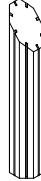
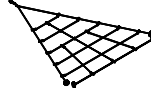
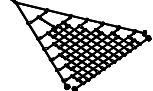
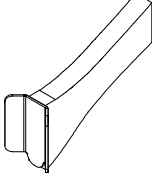
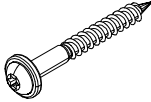
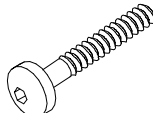
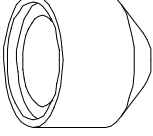
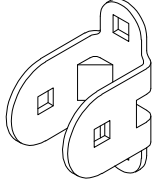
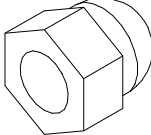
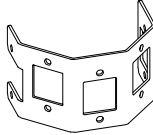
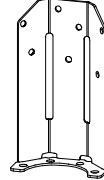
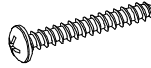
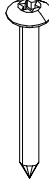
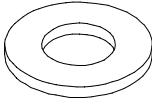
702286  65x65	PCS 1	702339  118x78	PCS 1	708573-001  140x140x1200	PCS 3	708575-001  140x140x800	PCS 1	708663 	PCS 1	709183 	PCS 1
711514-001  1	PCS 1	900240  Ø8x70	PCS 28	901899  M8x45	PCS 2	903093  Ø8x90	PCS 16	903112  L=750	PCS 4	905104  M10	PCS 32
909561  2	PCS 2	909633  M8	PCS 2	910566 	PCS 2	911916  4	PCS 4	980114  Ø4x20	PCS 8	980123  Ø7x60	PCS 16
980151  Ø16/8.4	PCS 4		PCS		PCS		PCS		PCS		PCS
	PCS		PCS		PCS		PCS		PCS		PCS
	PCS		PCS		PCS		PCS		PCS		PCS
	PCS		PCS		PCS		PCS		PCS		PCS