

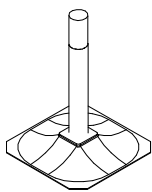









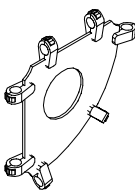

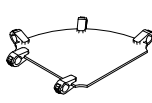

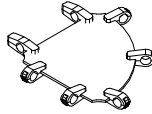

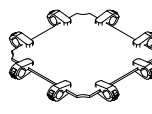

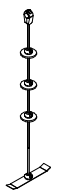

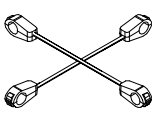

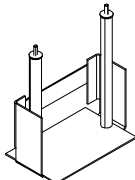

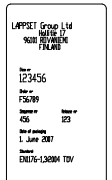

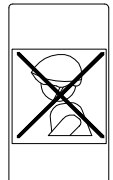

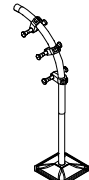

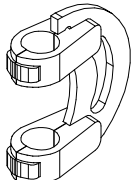

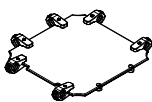

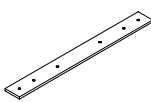

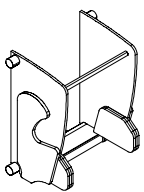

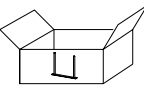

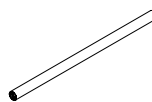

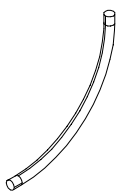



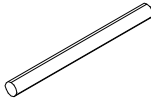

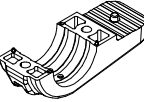

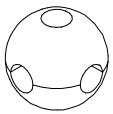

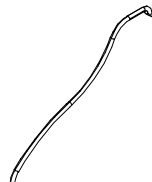



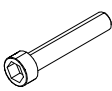



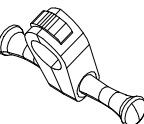

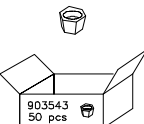

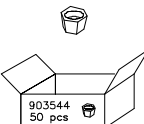



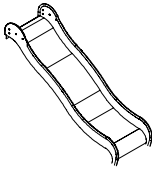



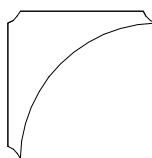

DATE: 10.2.2025

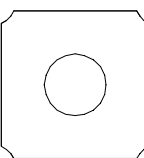
701985  16 	701986  1 	701997  2 	702000  2 	702056  3 	702151  1 	702153  6 	702285  1 	702341  1 90x50 	702633  1 90x50 	704014  1 	704159  3 	704666  1 	707133  1 10x80x745 	708858  1 	709045  1 	901868  2 Ø34x598 	901941  12 	901991  10 L 1493 	902022  37 L 710 	902124  76 150x50x50 	902134  54 	902141  2 60x60x2 	902157  137 	902232  38 M10x55 	902233  38 M10x30 	902253  2 	903699  3 M10/50pcs 	903700  4 M12/50pcs 	904032  5 L 2278 	909708  1 +870 	980161  76 M10 	P01347  1 	P01348  1 668x668x15 	P01349  3 668x668x15 	P01350  1 	P01351  1 
---	---	---	---	---	---	--	---	--	--	---	---	--	--	--	---	--	---	--	---	---	--	--	---	--	--	---	--	--	---	--	---	---	---	---	---	--

- EN/AS Impact Area 44.5 m<sup>2</sup>
- - - Falling Space 44.5 m<sup>2</sup>  
Max Falling Height 1820 mm

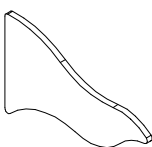

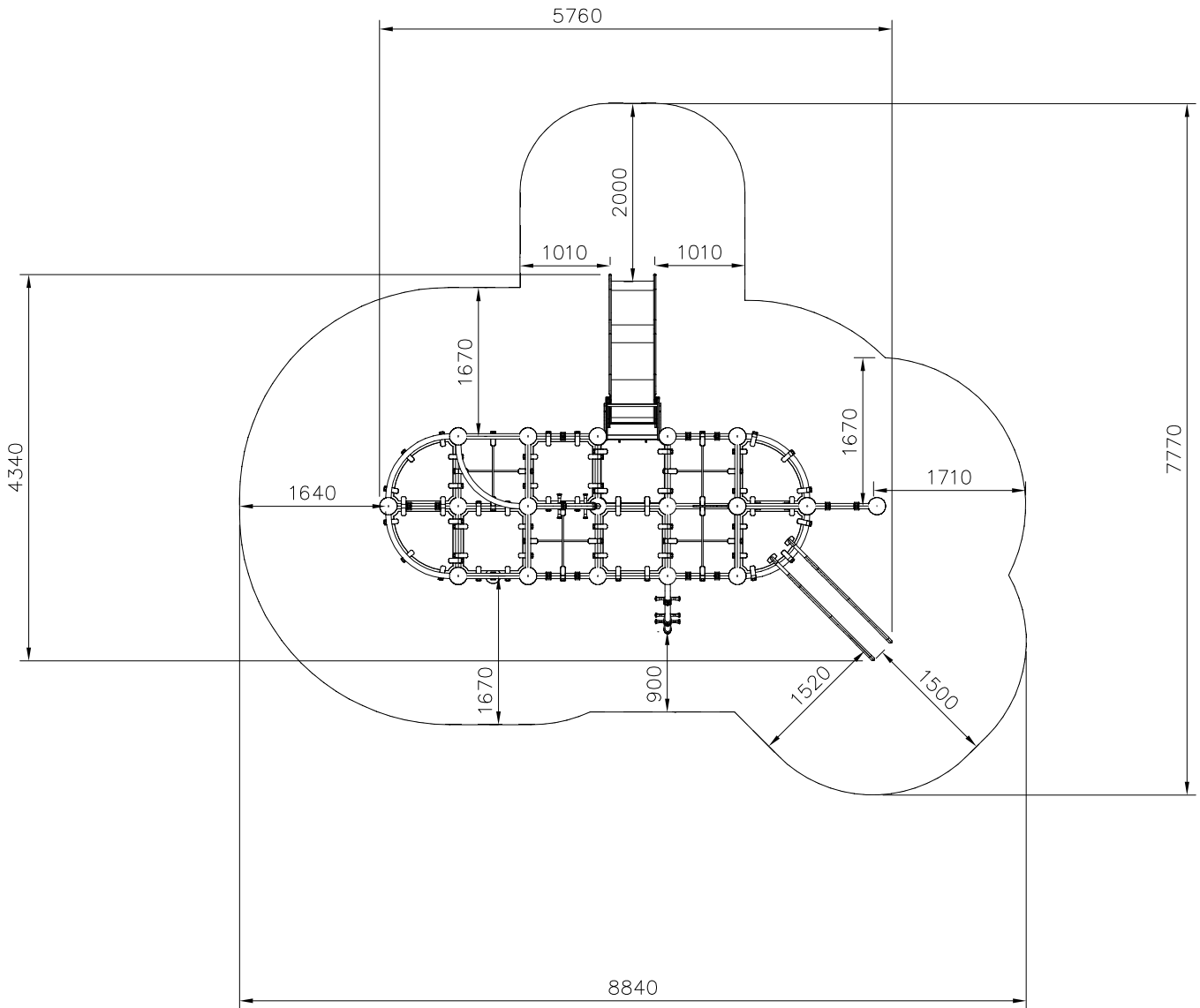
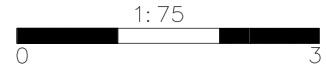
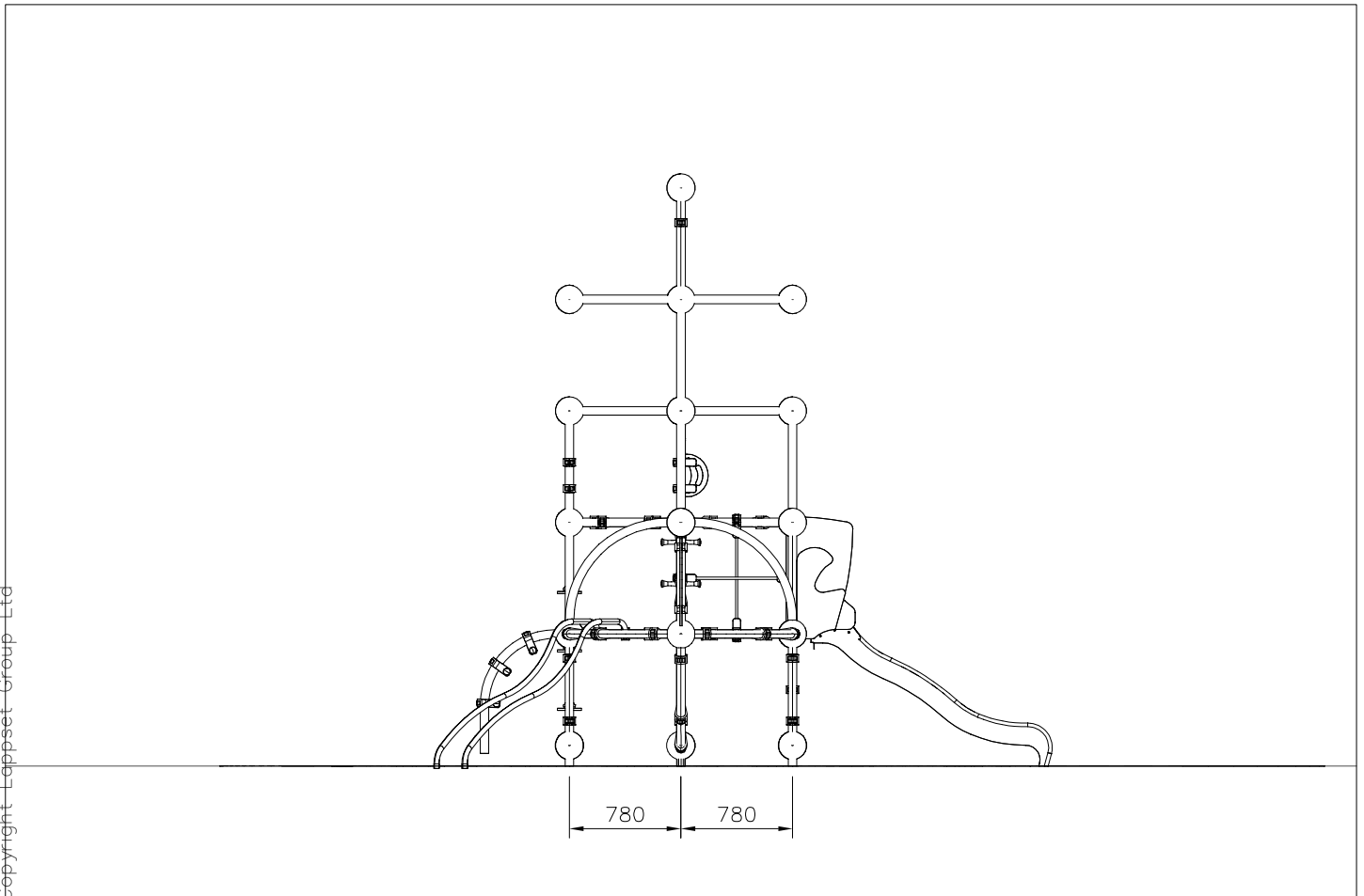
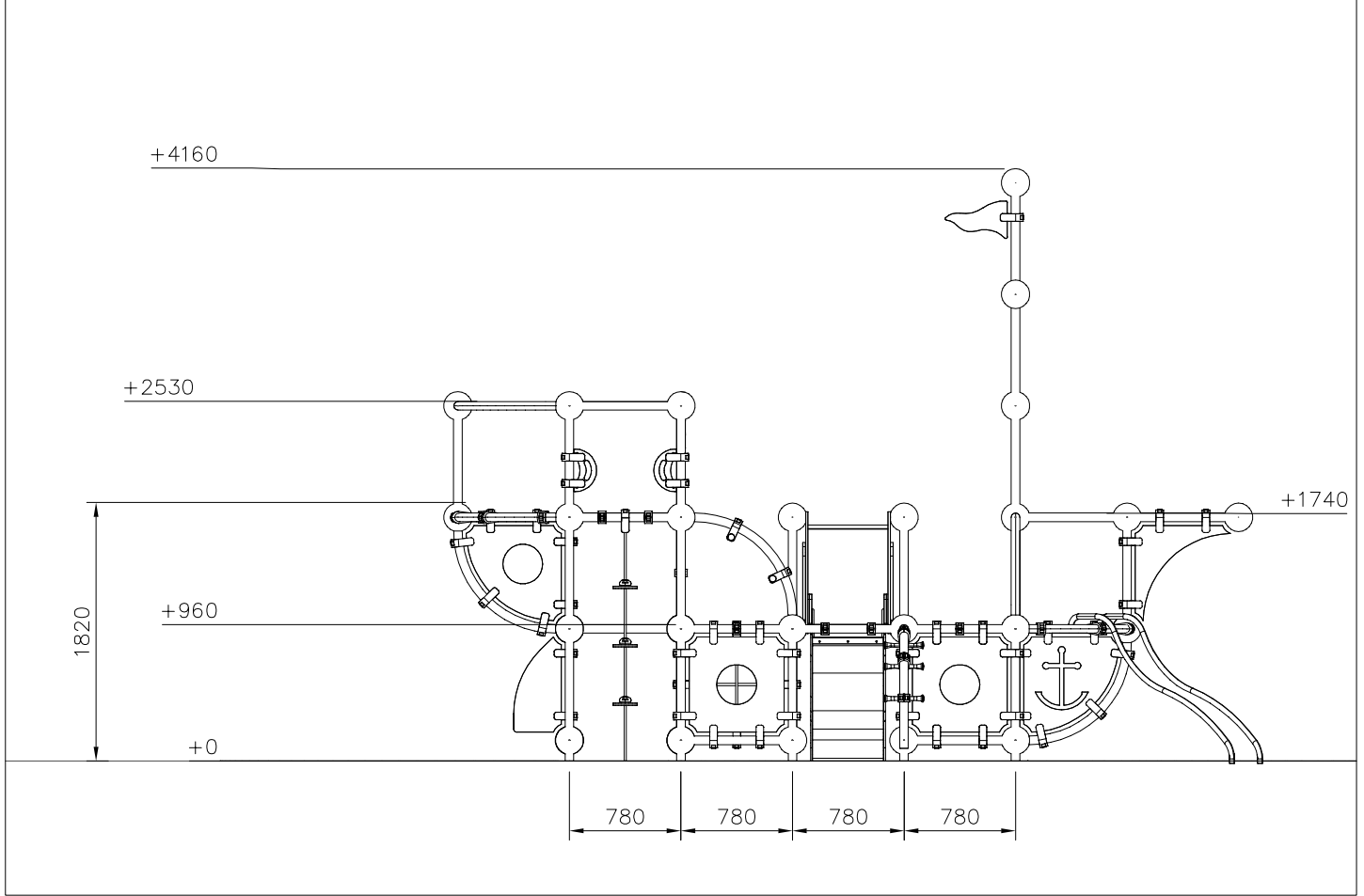

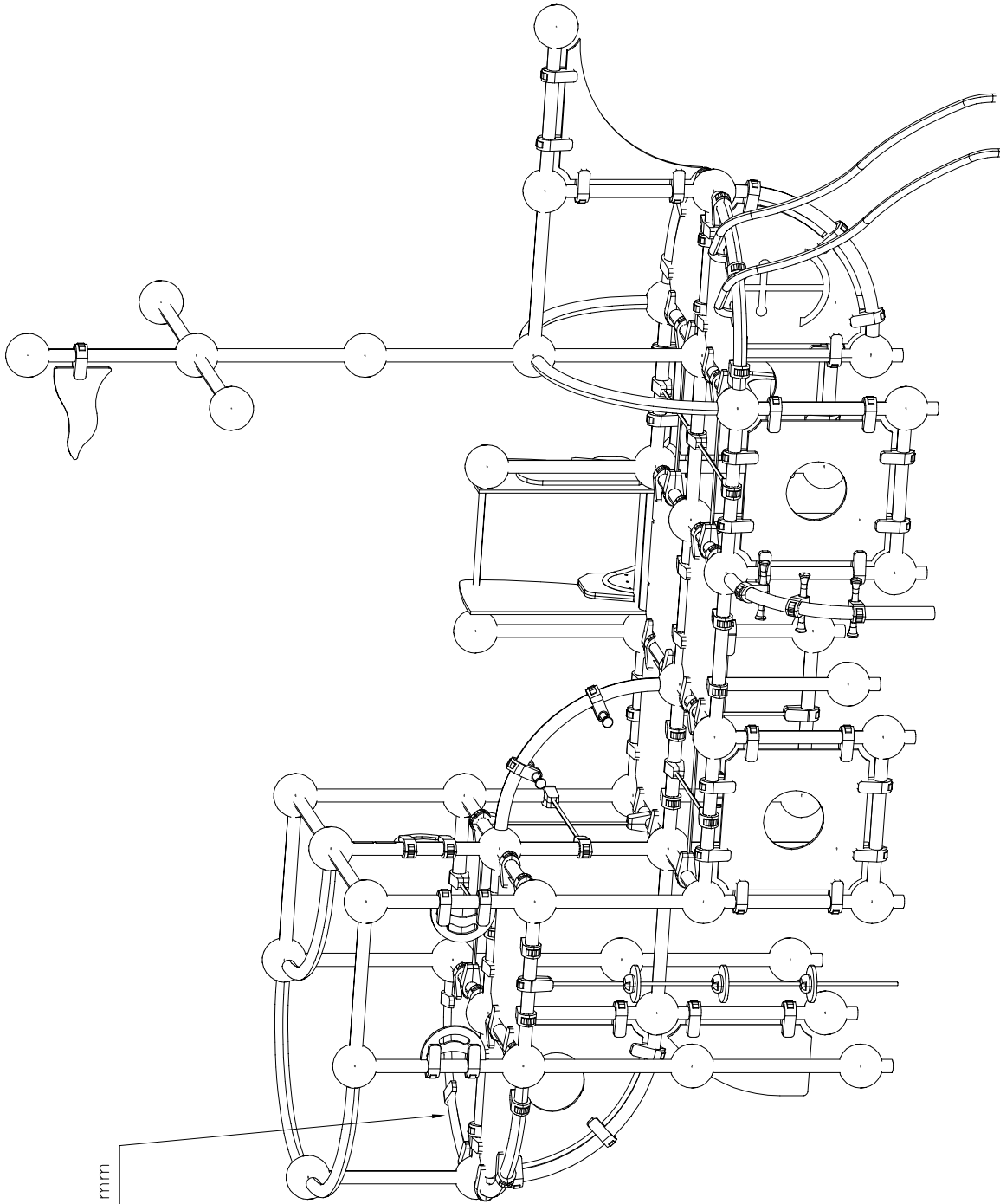

Max Falling Height 1820 mm

