

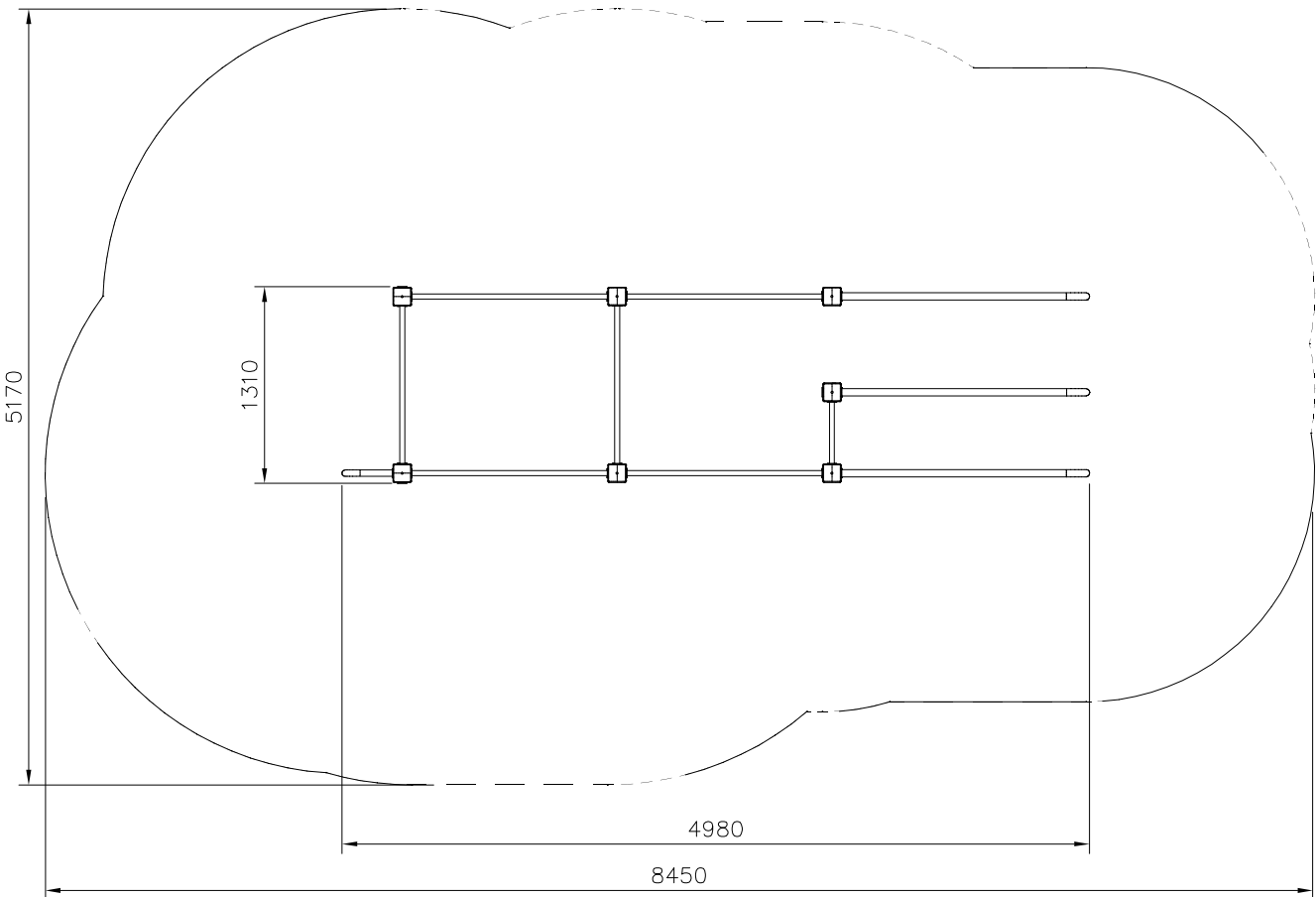

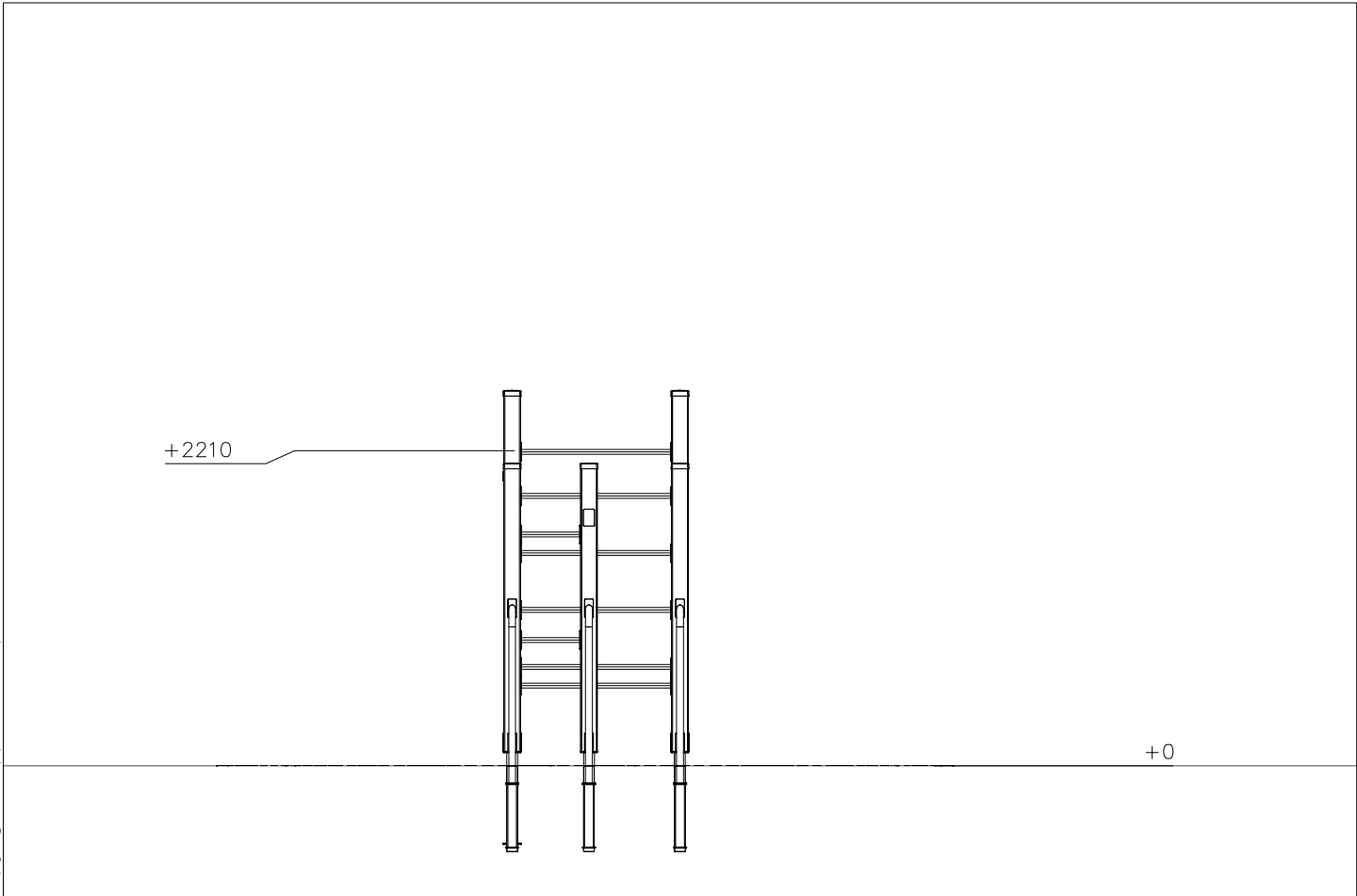

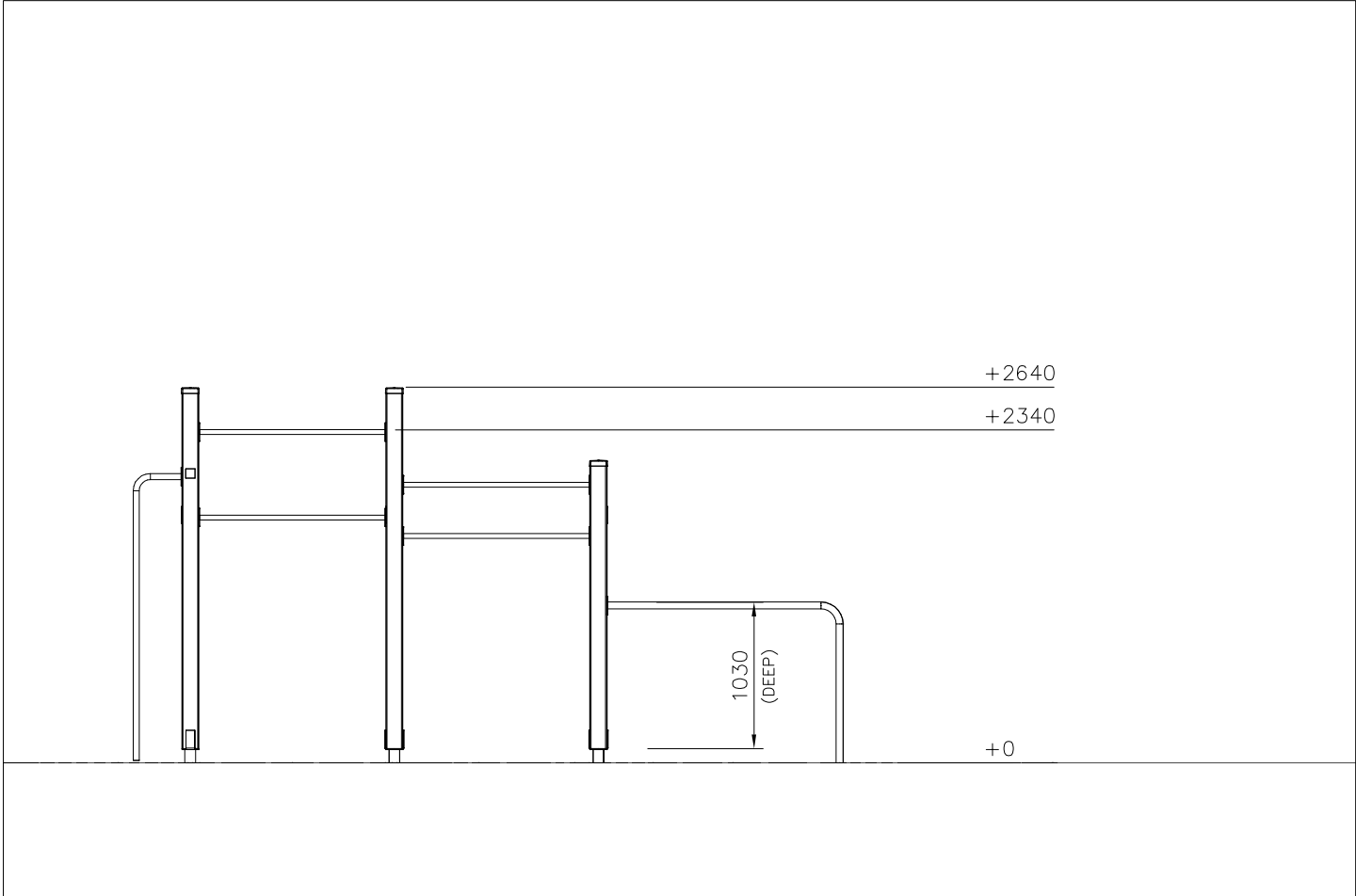



—— EN/AS Impact Area 36.8 m²
- - - - Falling Space 36.8 m²
- - - - Max Falling Height 0000 mm



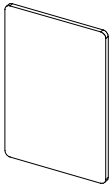
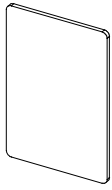
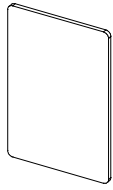
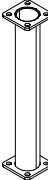
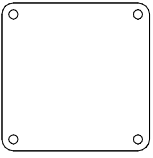
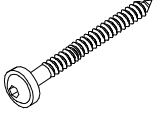
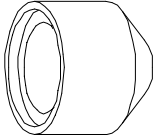
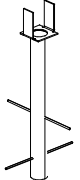

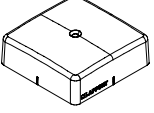
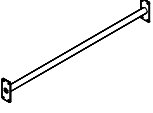
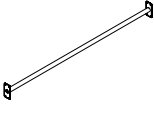
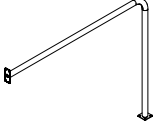
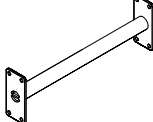
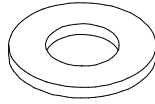
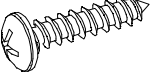
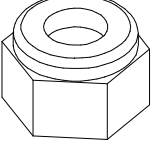
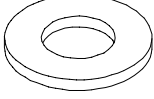
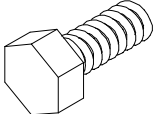
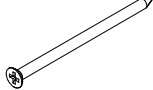
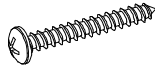
DATE: 10.2.2025

702286  90x50	PCS 1	705322-602  118x118x2500	PCS 4	705347-602  118x118x1990	PCS 3	707881  118x78	PCS 1	707882  118x78	PCS 1	707883  118x78	PCS 1
902272  90x90x450	PCS 3	902487  65x65	PCS 1	903093  Ø8x90	PCS 12	905104  M10	PCS 16	905761  120x120x700	PCS 7	905817-217  2626x386x60	PCS 1
905830  123x123x40	PCS 7	905838-217  L 1060	PCS 7	908017-217  L 1315	PCS 4	908019-217  1500x1200	PCS 3	908062-217  L 420	PCS 2	909256  Ø16/8.4	PCS 148
909506  Ø3.5x13	PCS 4	909637  M10	PCS 12	909638  Ø20/10.5	PCS 24	909639  M10x25	PCS 12	980104  Ø5x90	PCS 7	980114  Ø4x20	PCS 12
980123  Ø7x60	PCS 136										
	PCS		PCS		PCS		PCS		PCS		PCS
	PCS		PCS		PCS		PCS		PCS		PCS