

LAPPSET®

CLOVER







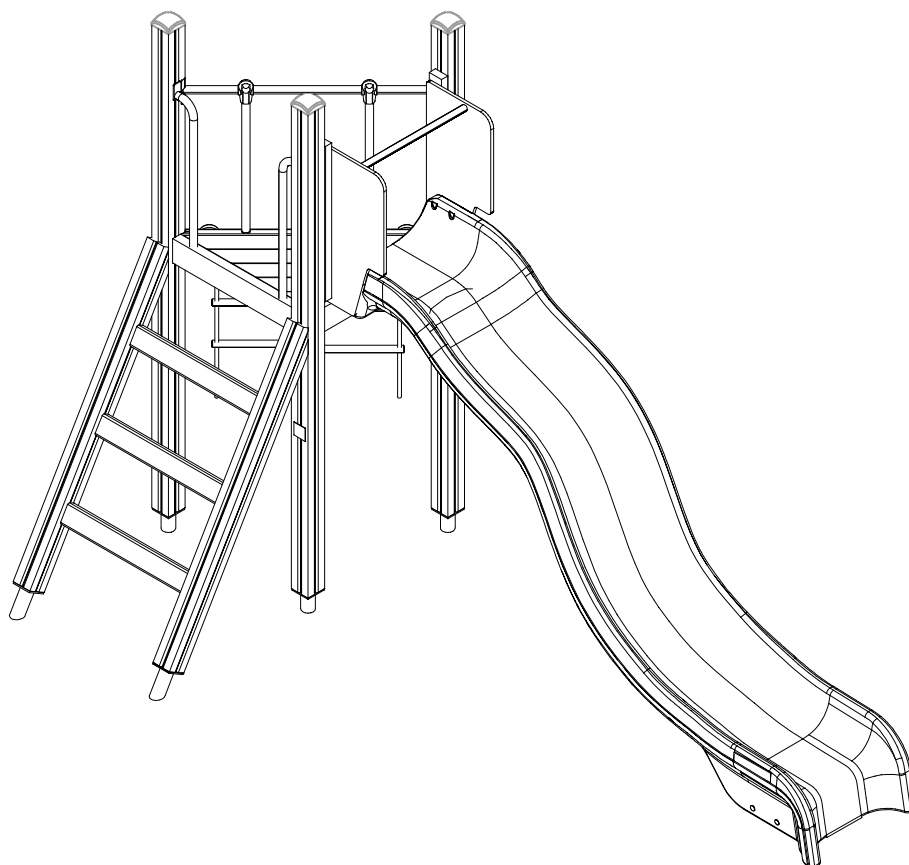



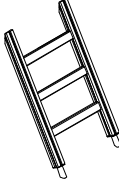
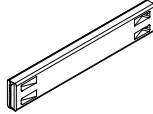
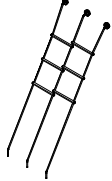

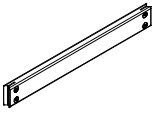
A SENNUSOHJE
MONTERINGSANSVISNING
INSTALLATION INSTRUCTION
AUFBAUANLEITUNG
NOTICE D'INSTALLATION

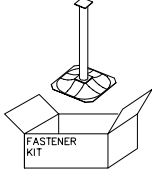
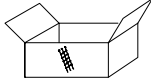
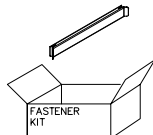
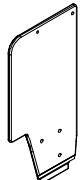
DATE: 27.1.2025

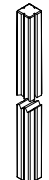
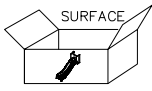
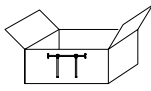
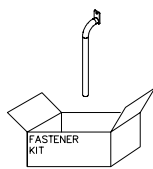
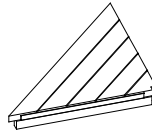
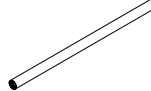
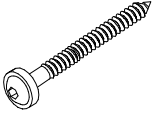
Q18765

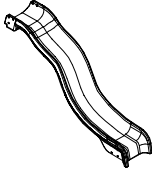
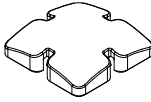
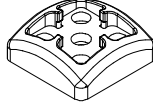

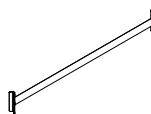
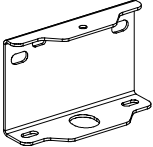
DATE: 27.1.2025

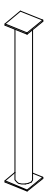
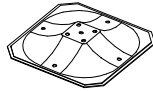
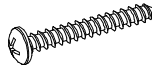
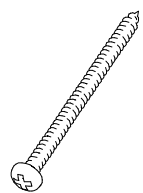
702286	PCS	703130	PCS	706439	PCS	706462-305	PCS	706505	PCS	706510	PCS
	1		1		2		1		2		1
65x65				L 704				35x70x730		45x120x1030	
706531	PCS	706536	PCS	706538	PCS	706560-705	PCS	706561-705	PCS	706669	PCS
	3		1		1		1		1		3
						15x765x370		15x765x370		93x93x2400	
706981	PCS	707625	PCS	707732	PCS	711533-001	PCS	901868	PCS	903093	PCS
	1		1		2		1		1		8
SLIDE 80M								Ø30x598		Ø8x90	
904451	PCS	905138	PCS	905196	PCS	907688-216	PCS	907920-216	PCS	908021	PCS
	1		3		3		2		1		2
+1470		GRAY		GRAY				120x40x1029		3x212x214	
908044-216	PCS	909511	PCS	909519	PCS	980114	PCS	980131	PCS		PCS
	2		3		5		4		12		
Ø33,7x679		90x90x650		50x380x380		Ø4x20		Ø6x60			
	PCS		PCS		PCS		PCS		PCS		PCS
	PCS		PCS		PCS		PCS		PCS		PCS

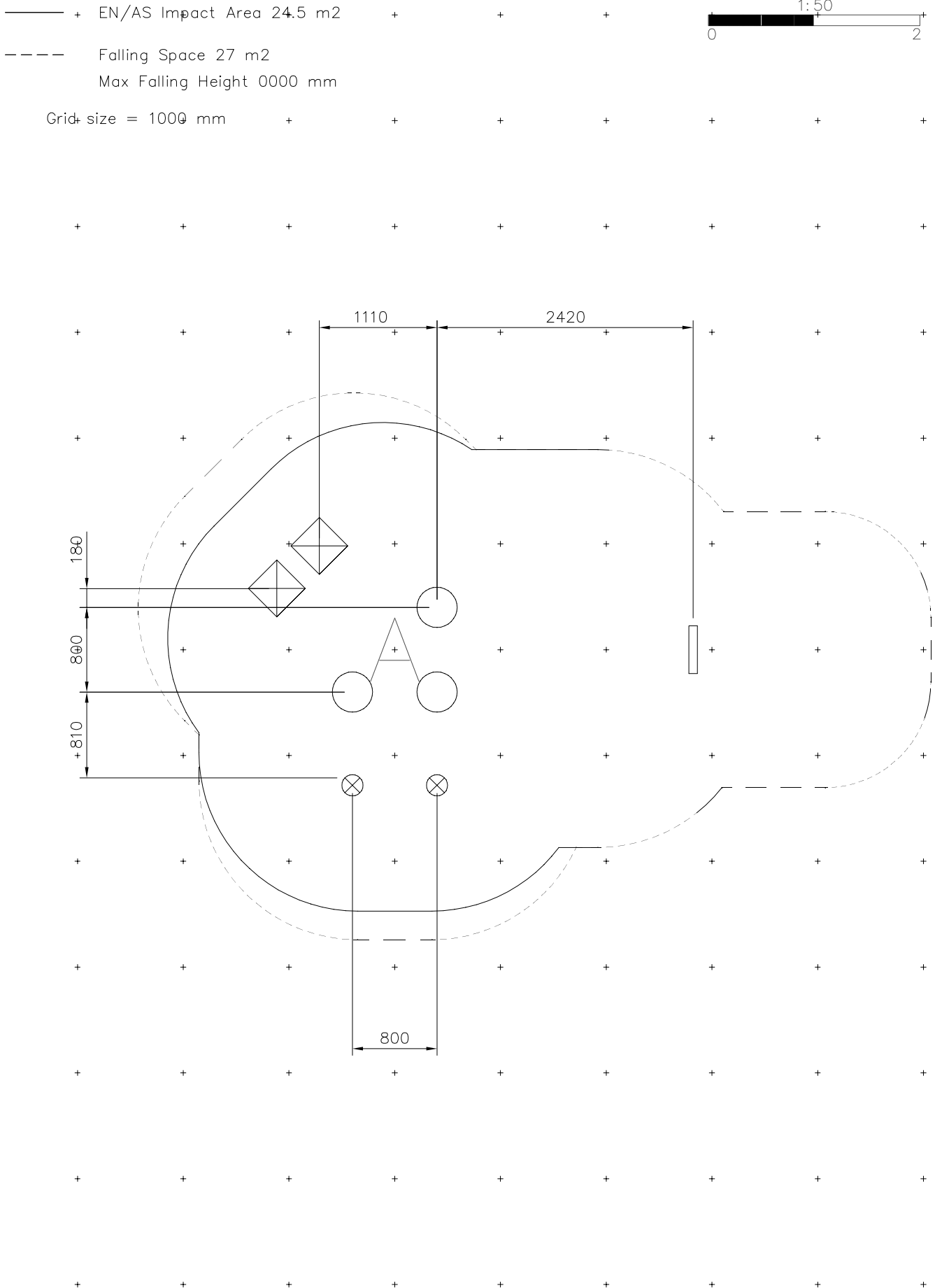

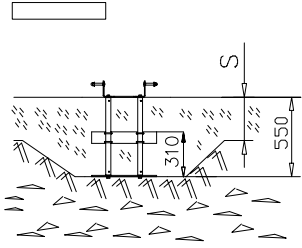
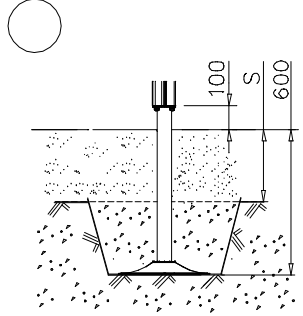
 <p>Technical drawing showing a cross-section of a drainage grate assembly. The grate is rectangular with a width of 310 and a depth of 550. The height of the grate is labeled as S. The drawing shows the grate sitting on a base with a sloped side and a central channel.</p>	 <p>Technical drawing showing a cross-section of a drainage grate assembly. The grate is rectangular with a width of 600 and a depth of 100. The height of the grate is labeled as S. The drawing shows the grate sitting on a base with a sloped side and a central channel.</p>	

- EN/AS Impact Area 24.5 m²
- - - Falling Space 27 m²
Max Falling Height 1470 mm

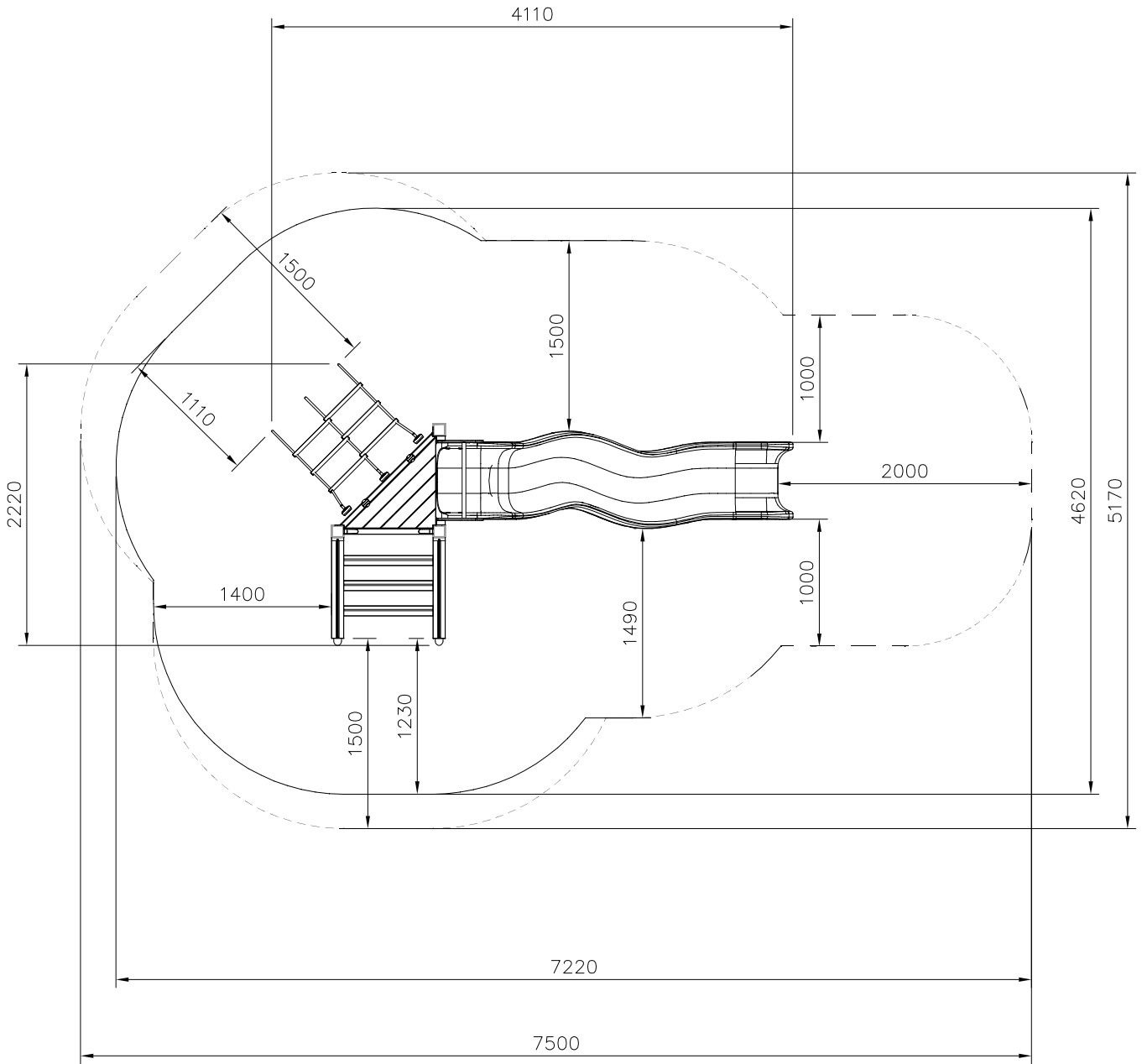

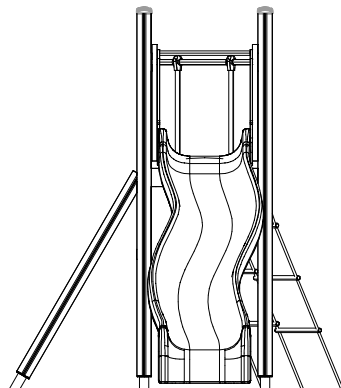
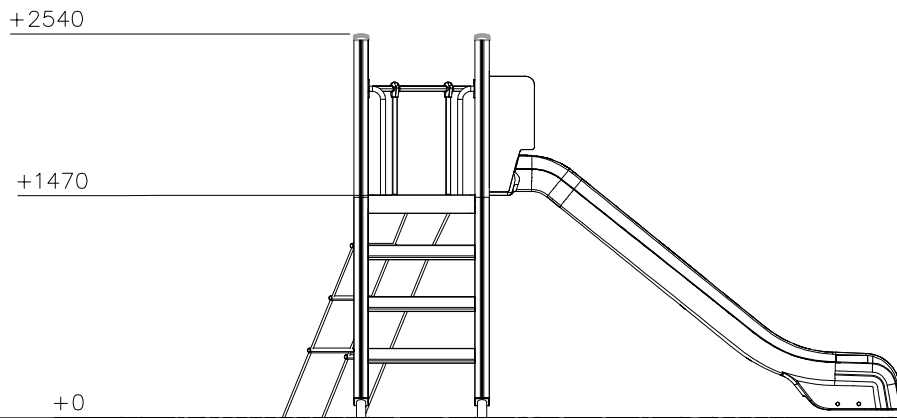

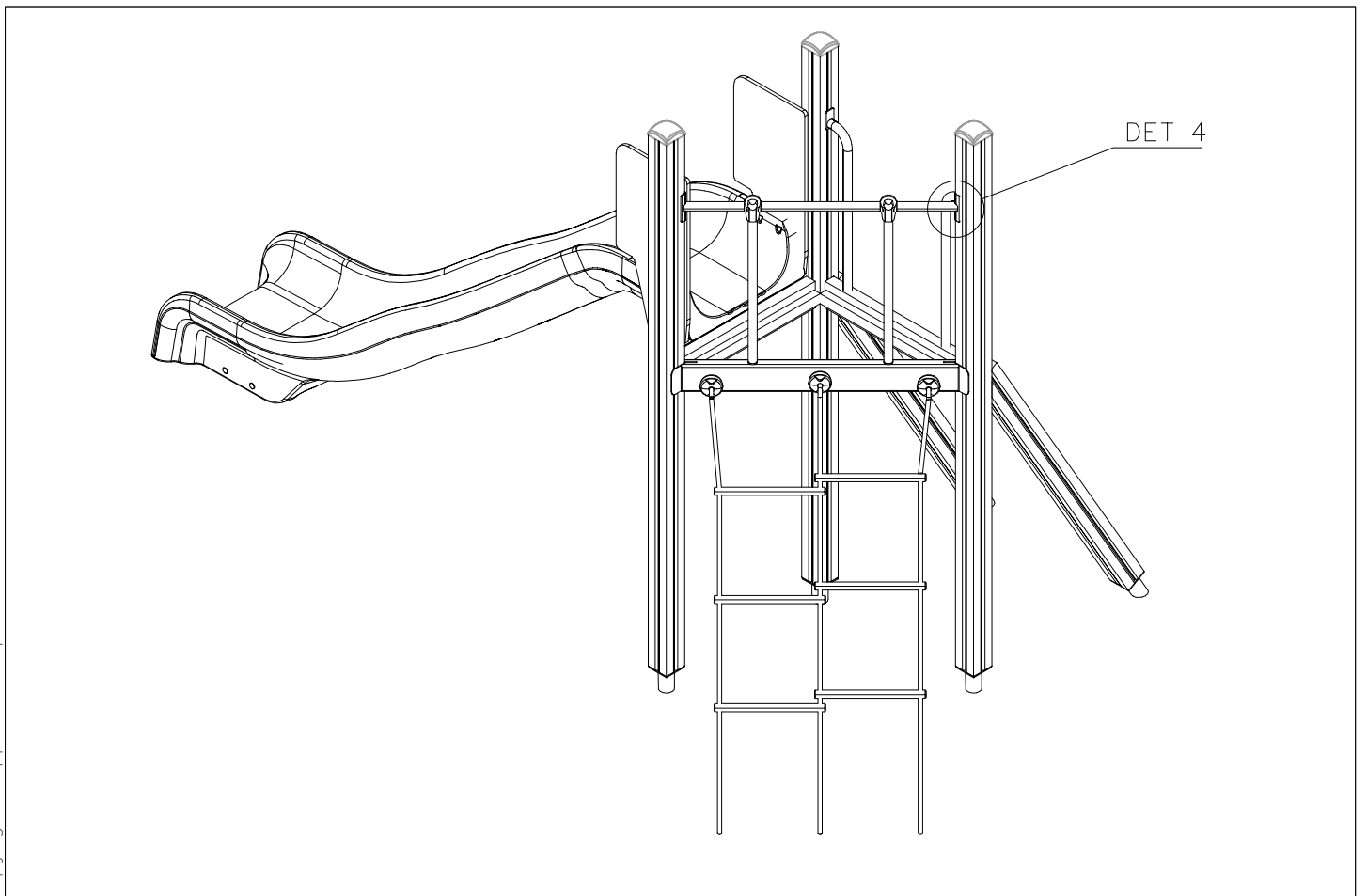
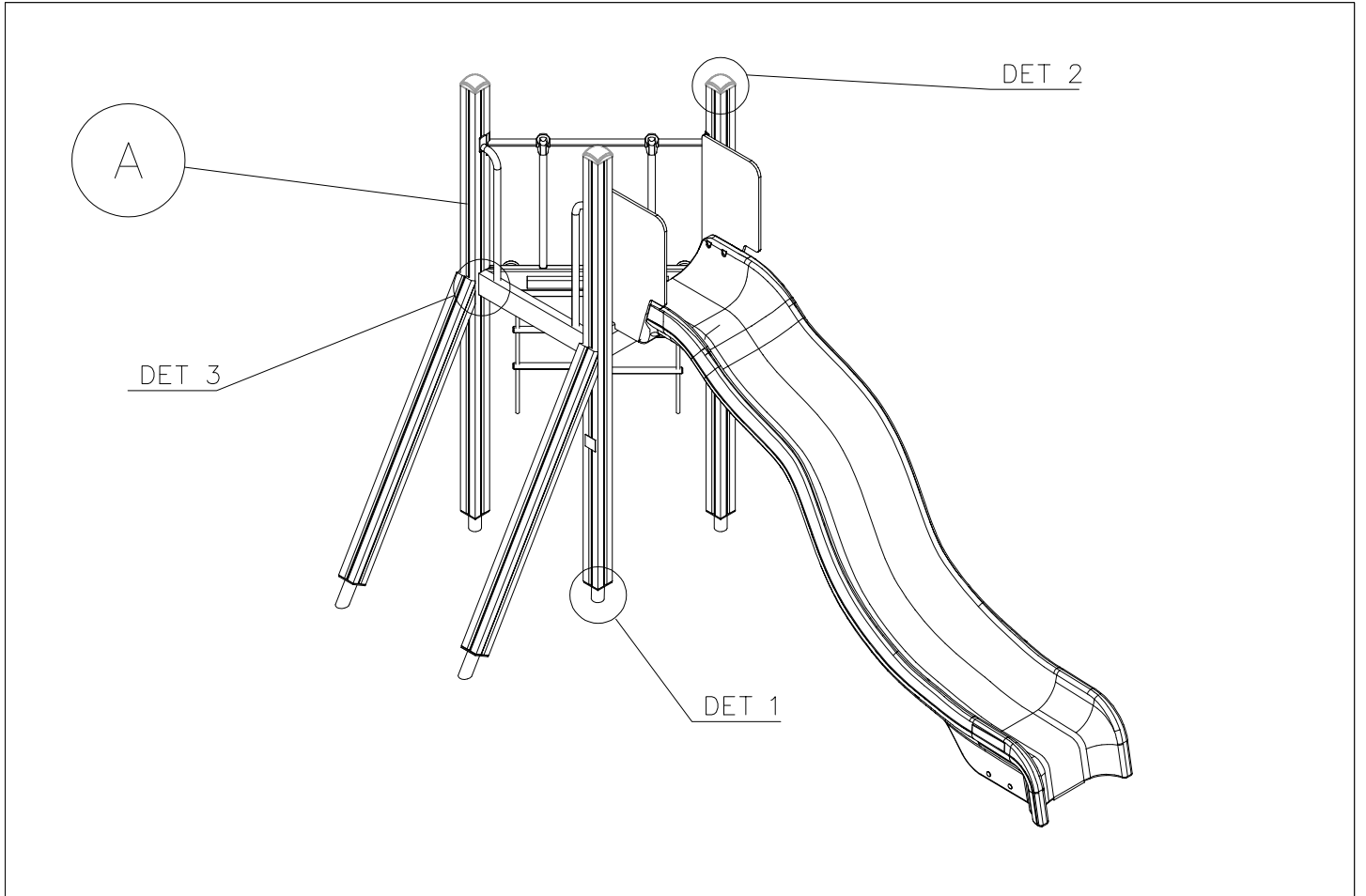

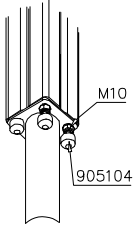
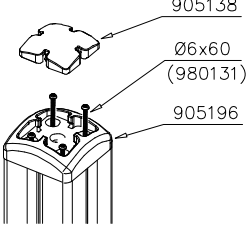
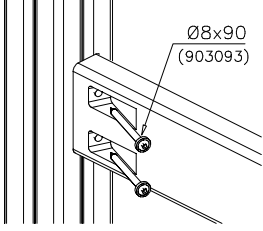
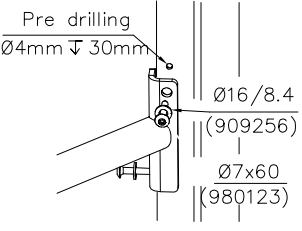
DET 1	DET 2	DET 3	DET 4
			

DATE: 27.1.2025

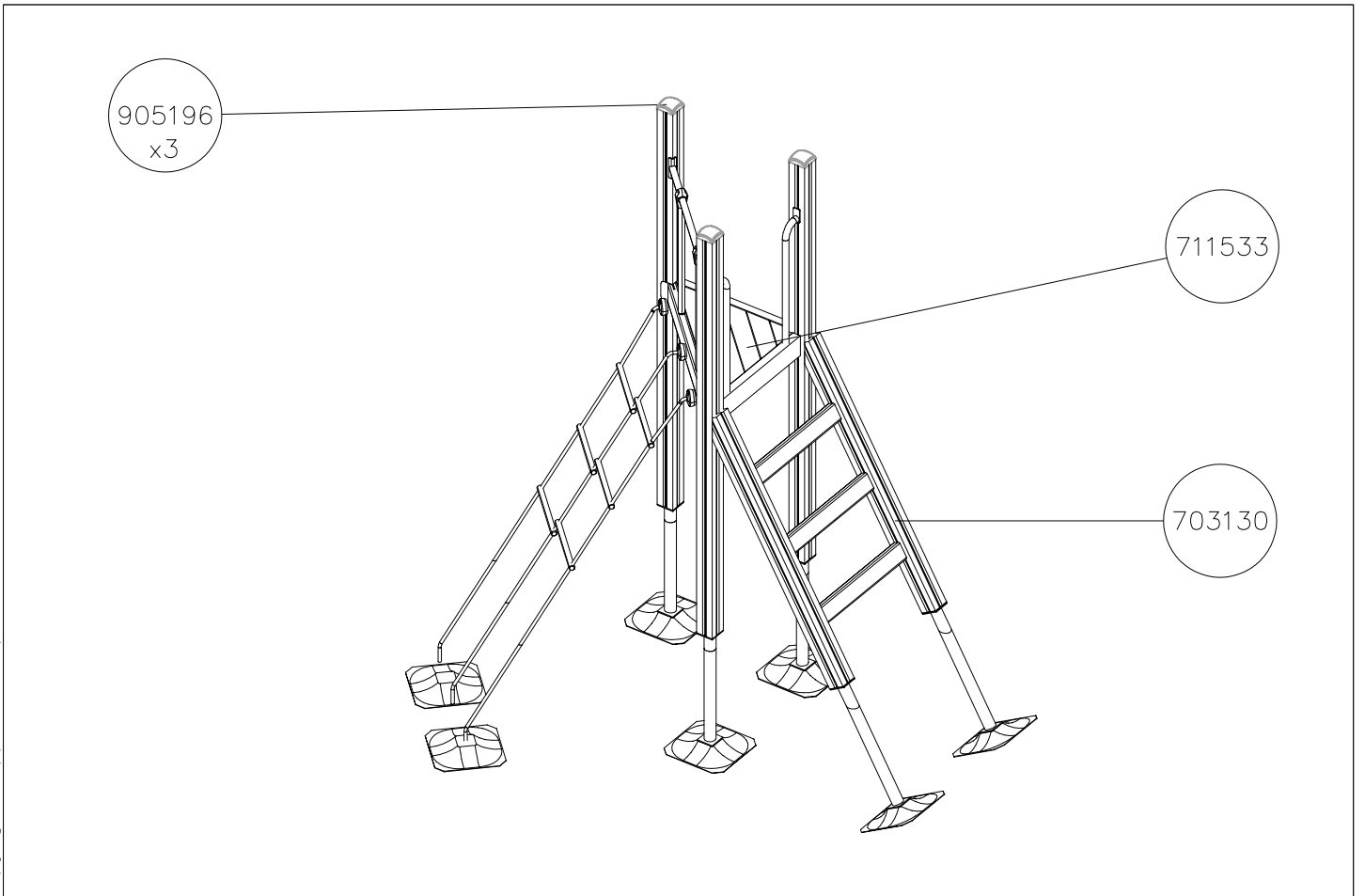
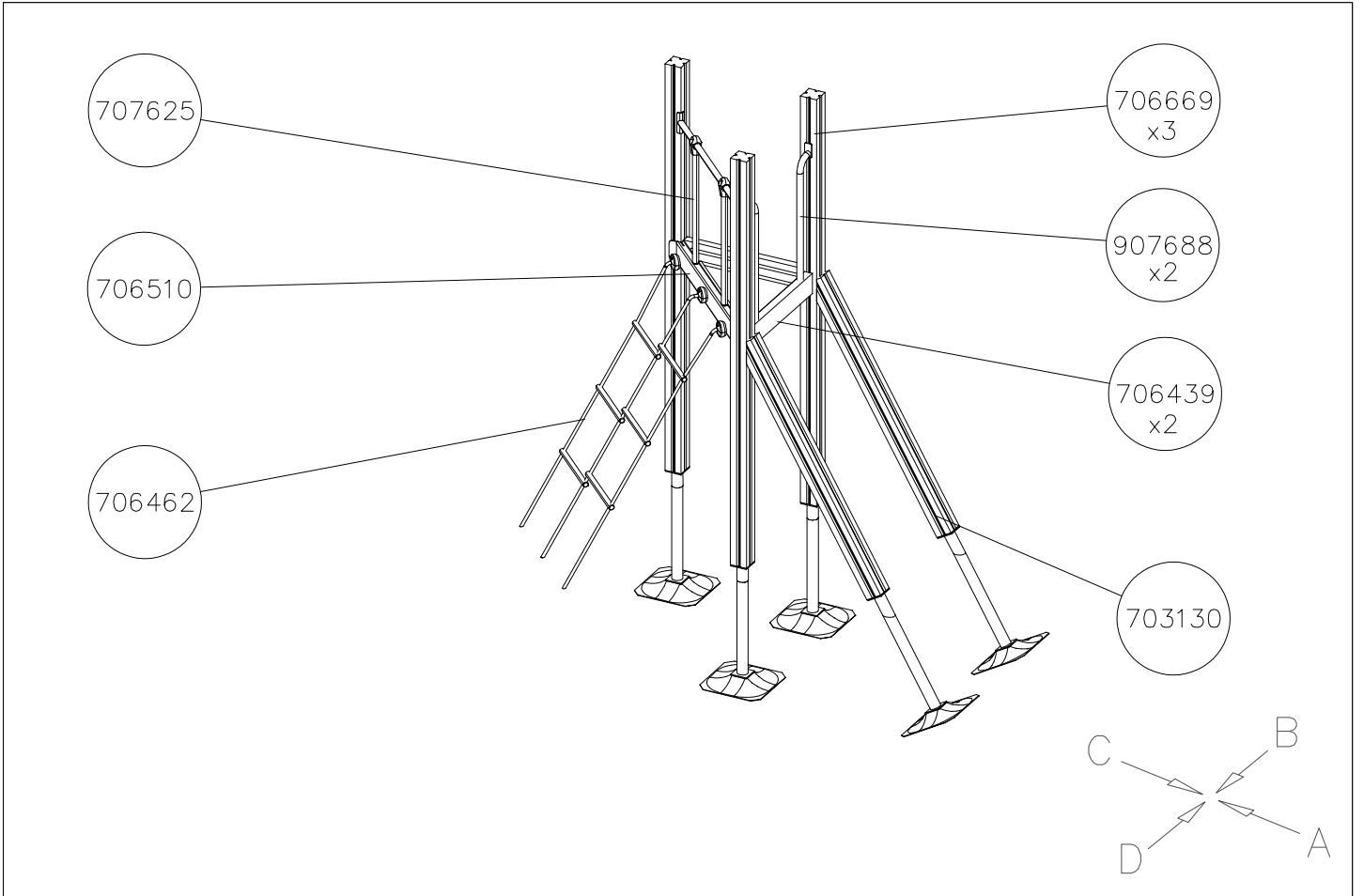

DATE: 27.1.2025

1:50

(A)

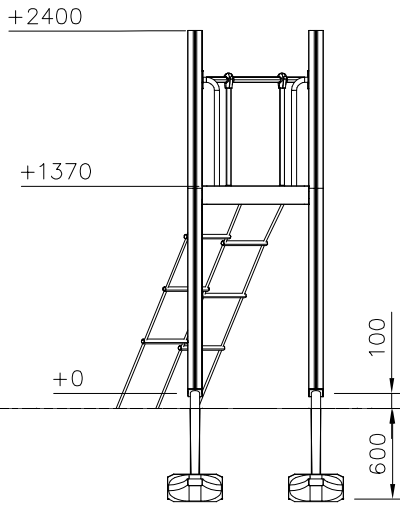

(B)

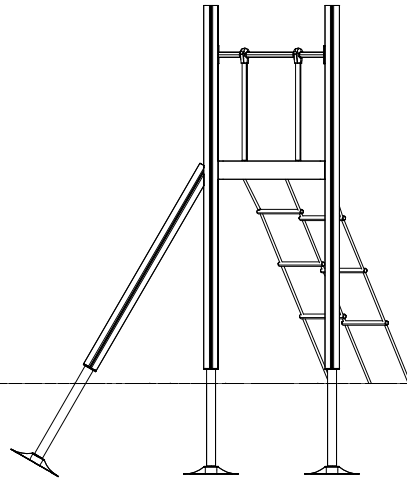

(C)

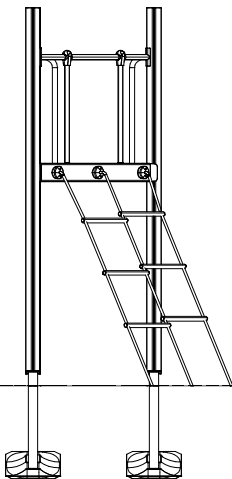

(D)

