

LAPPSET®

FLORA







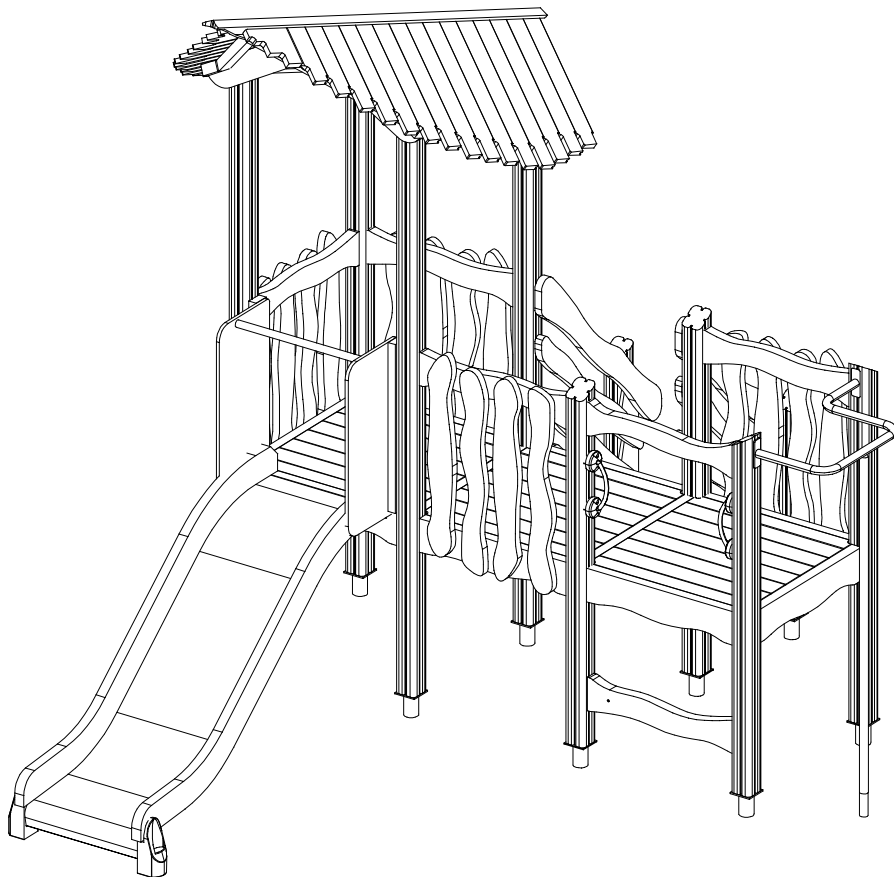



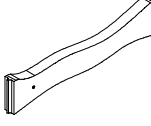
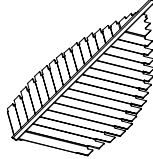

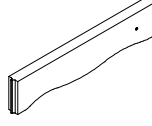
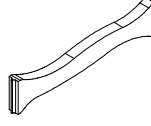
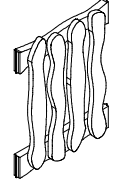

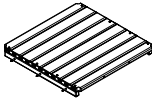



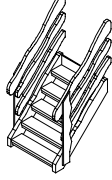

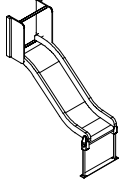
ASENNUSOHJE
MONTERINGSANSVISNING
INSTALLATION INSTRUCTION
AUFBAUANLEITUNG
NOTICE D'INSTALLATION

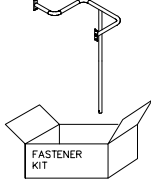
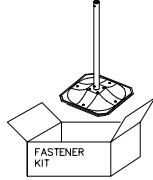
DATE: 24.1.2025

QFL0278

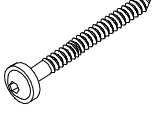
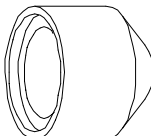
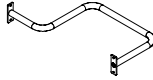

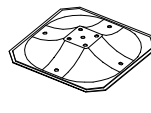
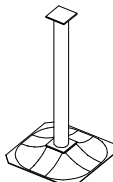
DATE: 24.1.2025

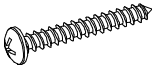
702286  65x65	PCS 1	705197-614  45x145x724	PCS 1	705203-614  	PCS 1	705211-614  45x145x715	PCS 6	705214-614  45x145x724	PCS 1	705230-614  	PCS 4
705258-614  	PCS 3	705511  	PCS 2	706178-614  93x93x2246	PCS 2	706180-614  93x93x2538	PCS 2	706185-614  	PCS 1	706192-614  93x93x946	PCS 2
706234-614  	PCS 1	706541  FASTENER KIT	PCS 1	706542  FASTENER KIT	PCS 1	711370-614  93x93x1546	PCS 4	901902  30.7x60.9x100	PCS 2	901916  L 650	PCS 1
903093  Ø8x90	PCS 30	905104  M10	PCS 40	907695-216 	PCS 1	907829-216  L 1454	PCS 1	909519  50x380x380	PCS 1	909521  	PCS 10
980114  Ø4x20	PCS 4		PCS		PCS		PCS		PCS		PCS
	PCS		PCS		PCS		PCS		PCS		PCS
	PCS		PCS		PCS		PCS		PCS		PCS

—+ EN/AS Impact Area 25.3 m²

- - - Falling Space 27.1 m²
Max Falling Height 1000 mm

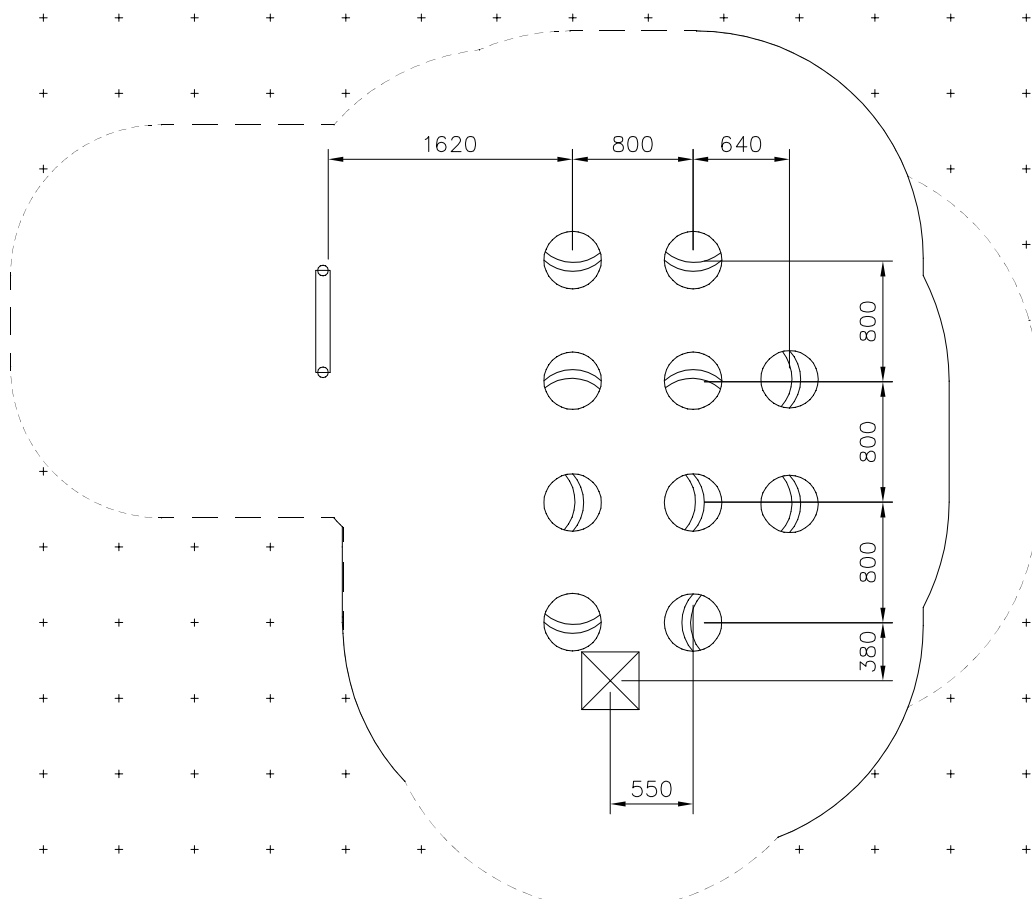
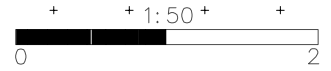

—— EN/AS Impact Area 25.3 m²
 - - - Falling Space 27.1 m²
 Max Falling Height 1000 mm

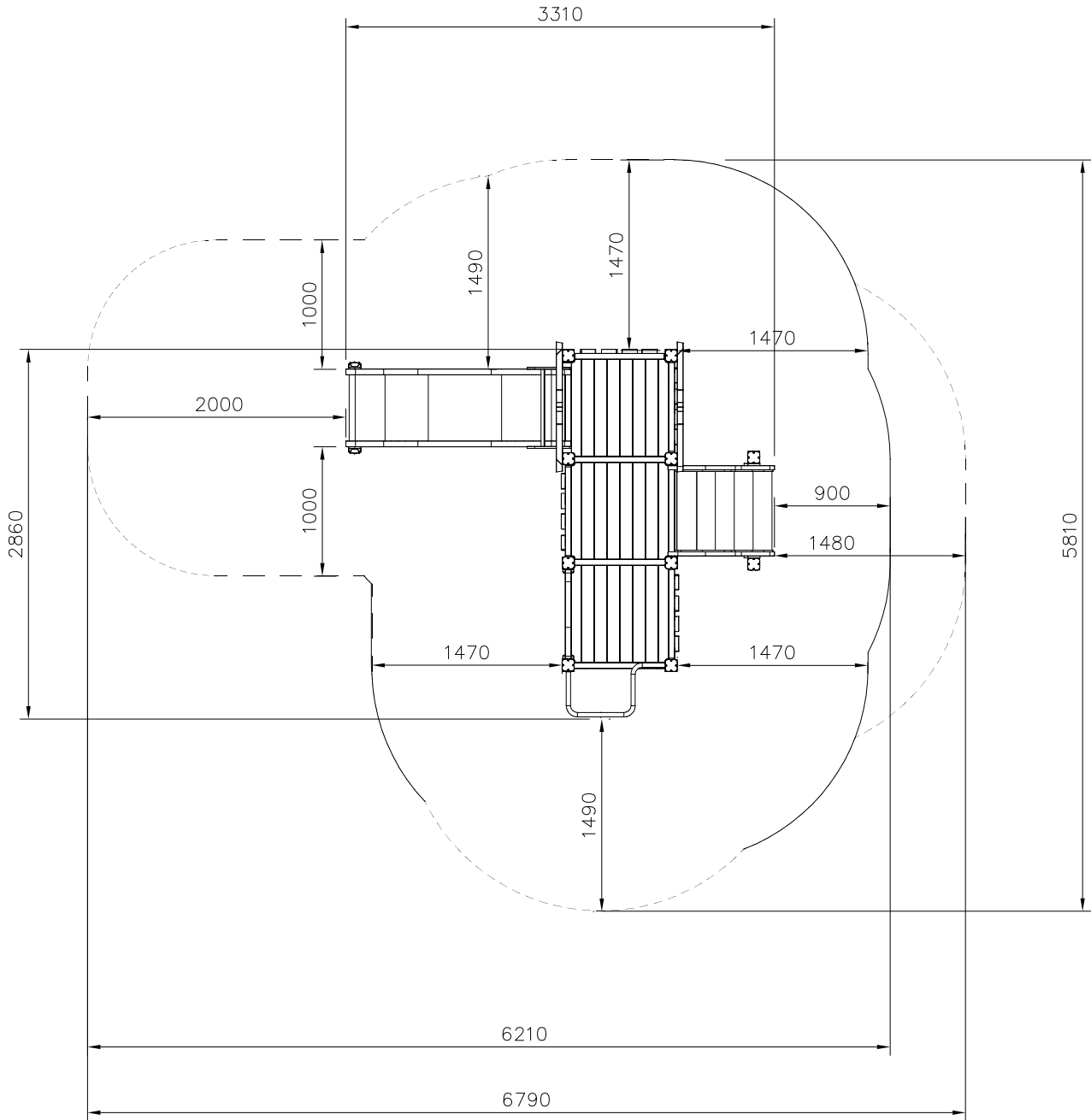
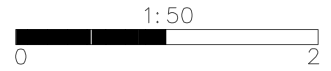

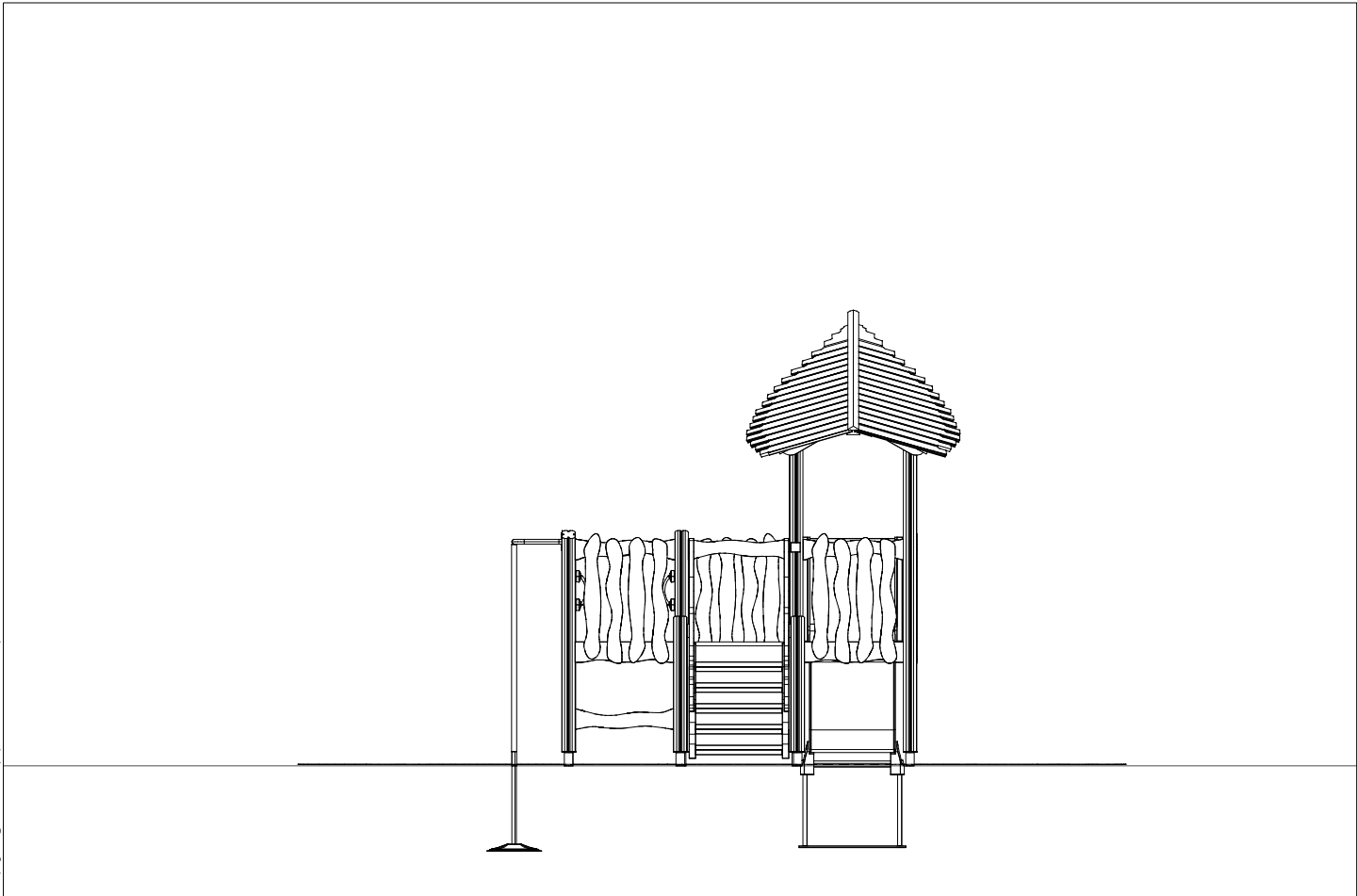
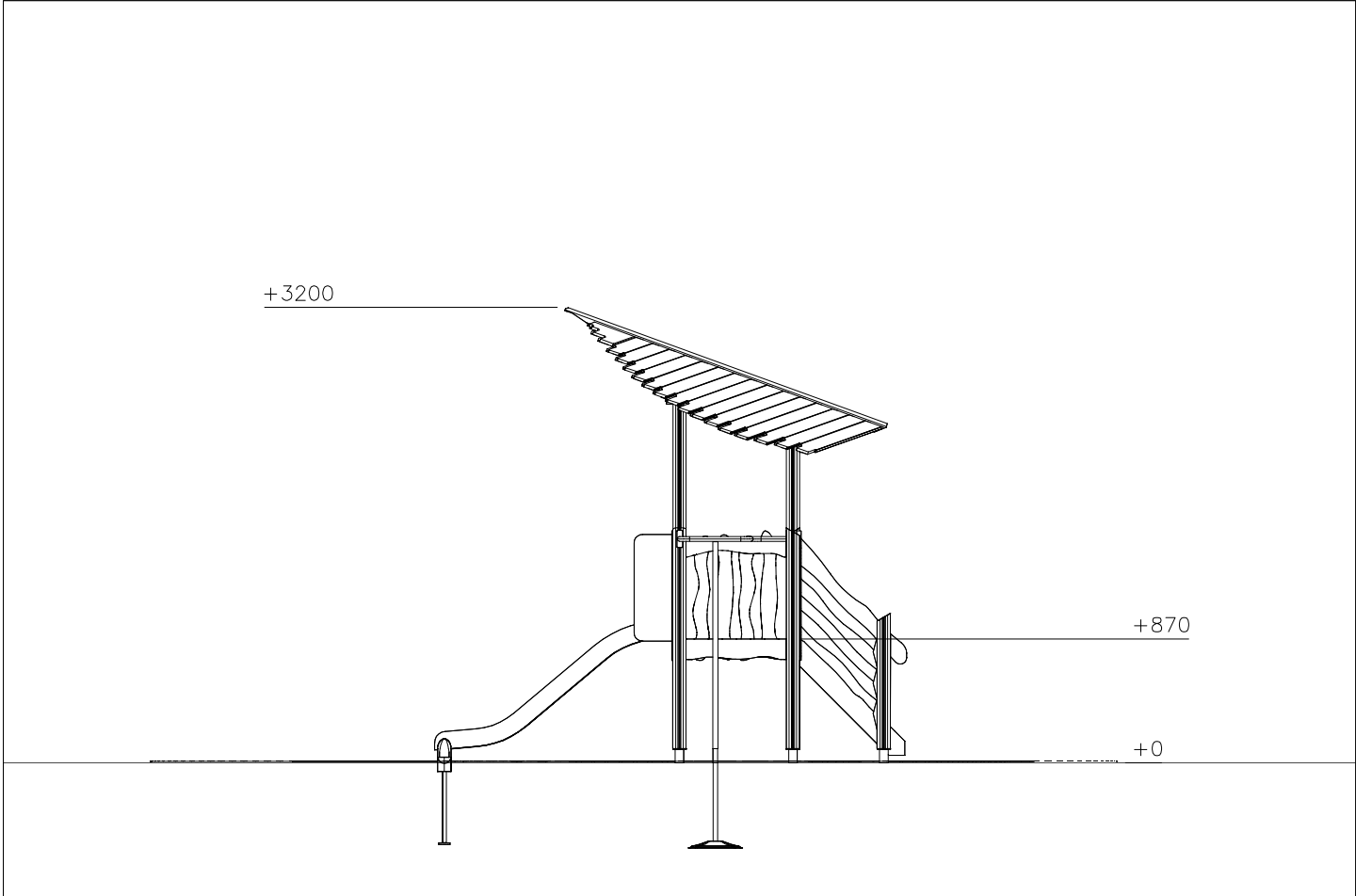

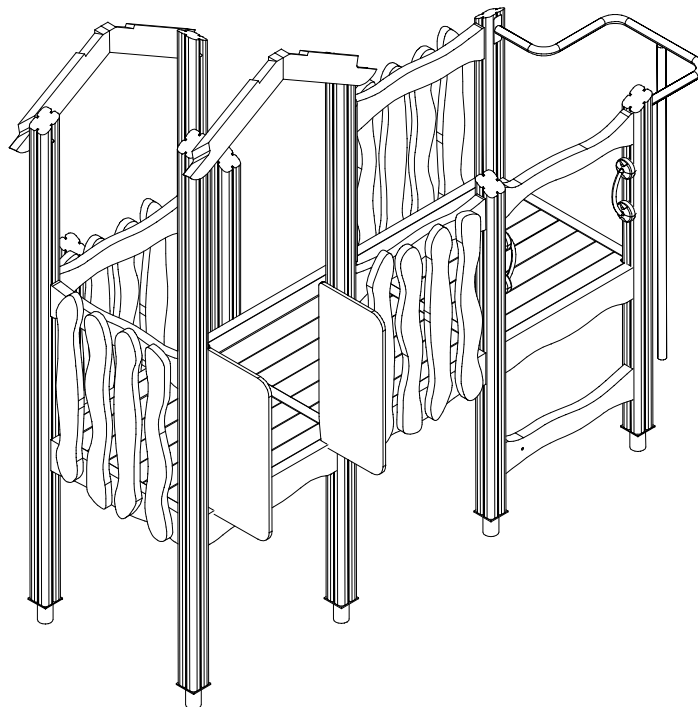
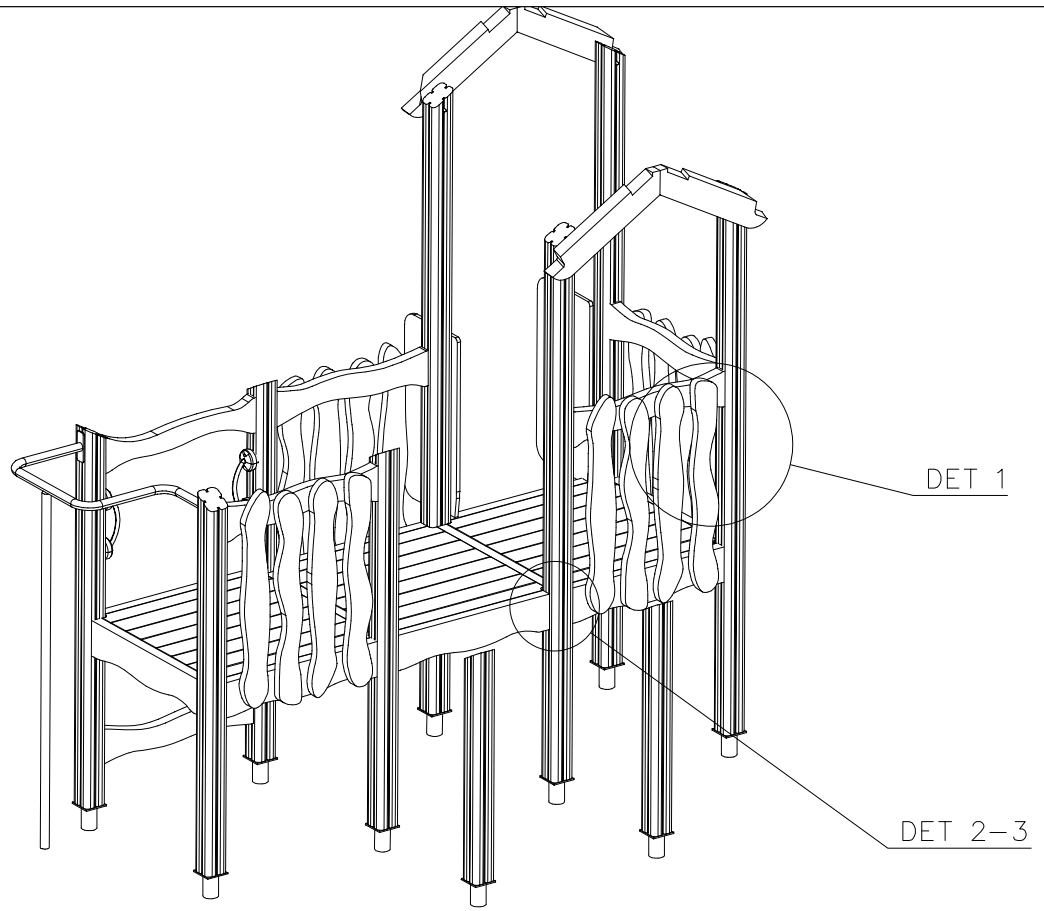

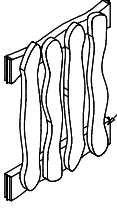
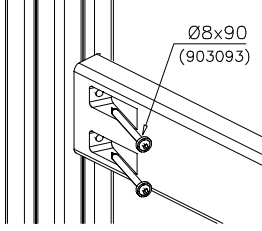
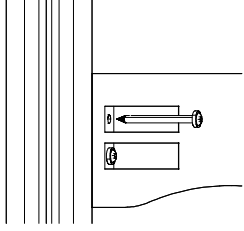
DET 1	DET 2	DET 3	
 <p>NOTE: Walls contain floor boom 705211. HUOM: Seinät sisältävät lattia puomin 705211.</p>			

DATE: 24.1.2025

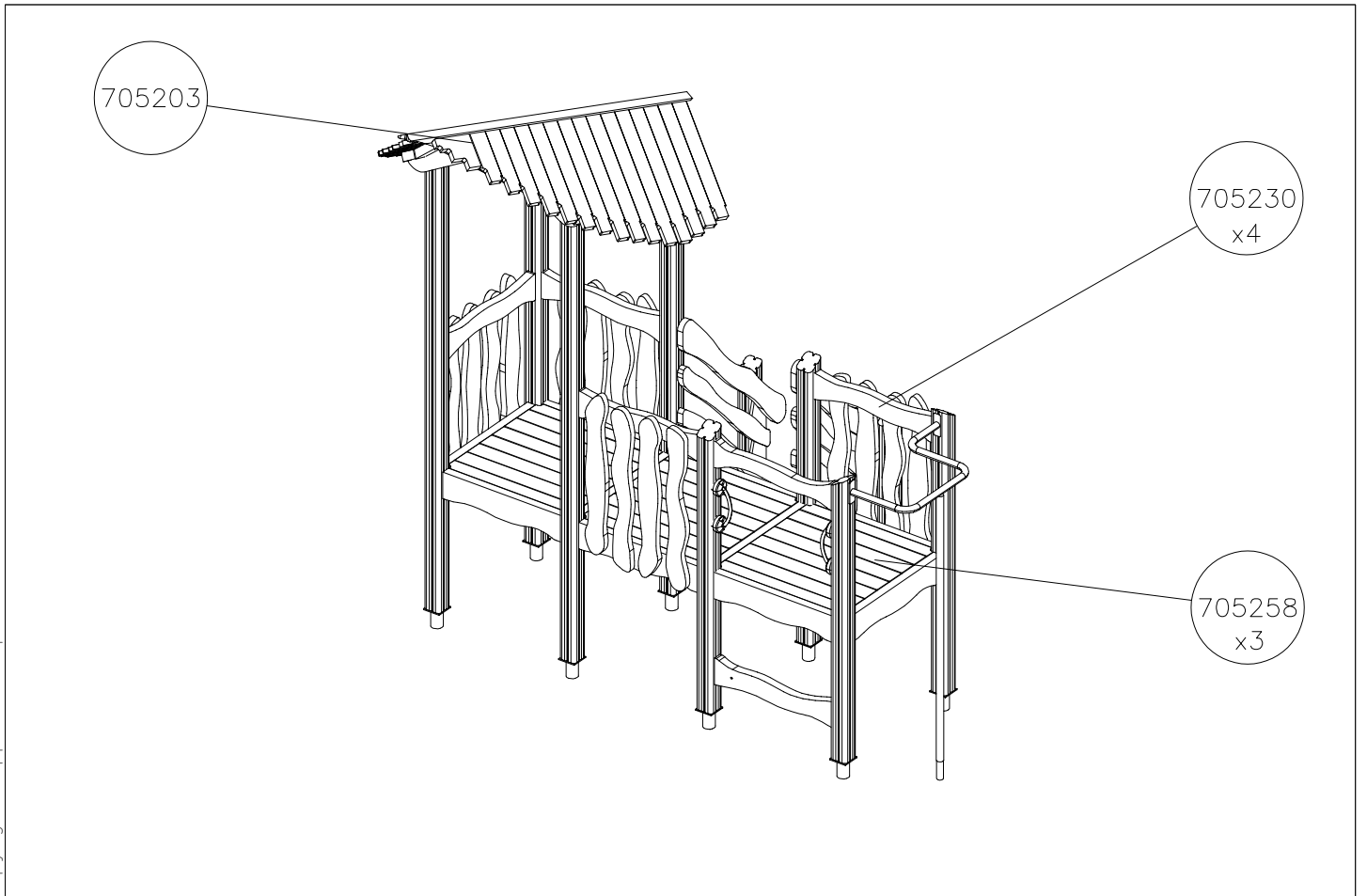
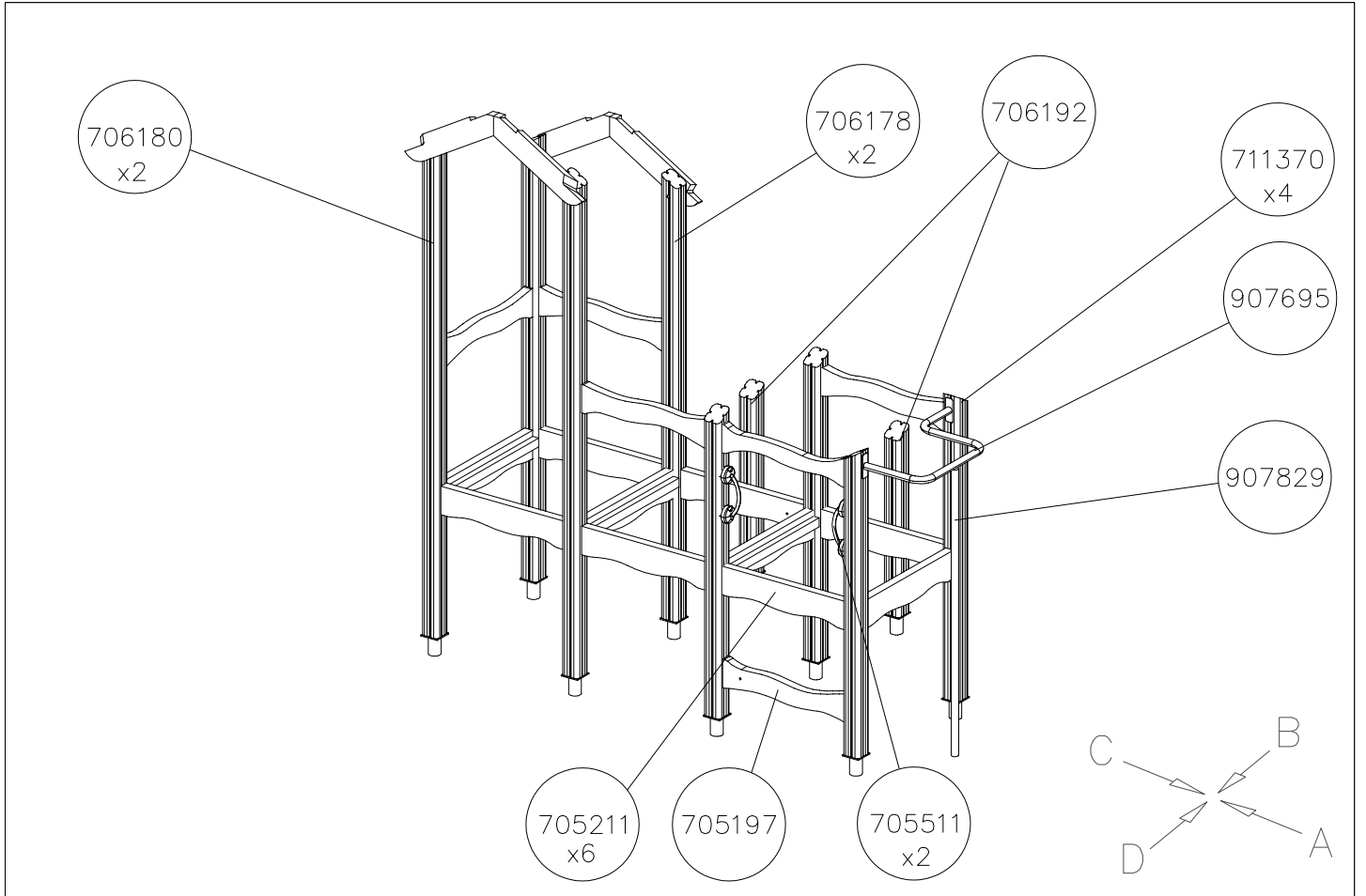

DATE: 24.1.2025

1:50

