

—— EN/AS Impact Area 16.7 m<sup>2</sup>

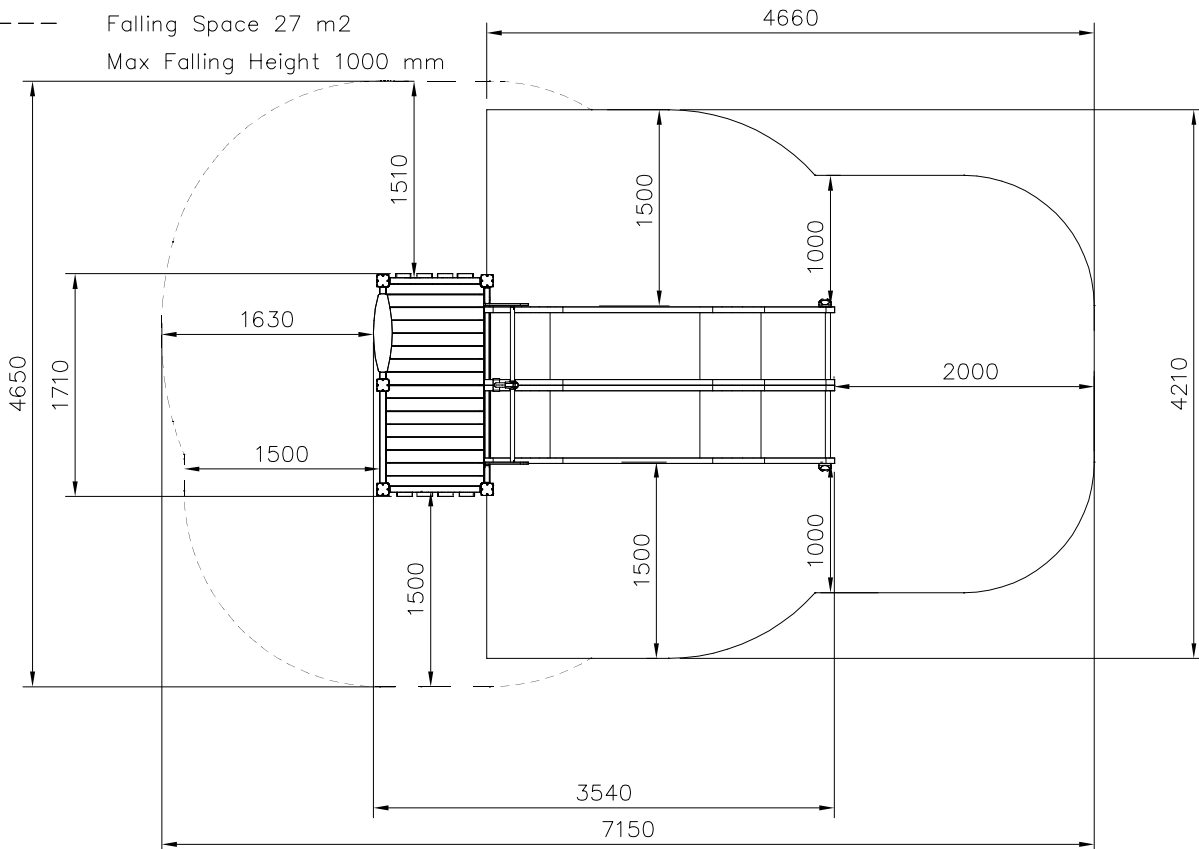

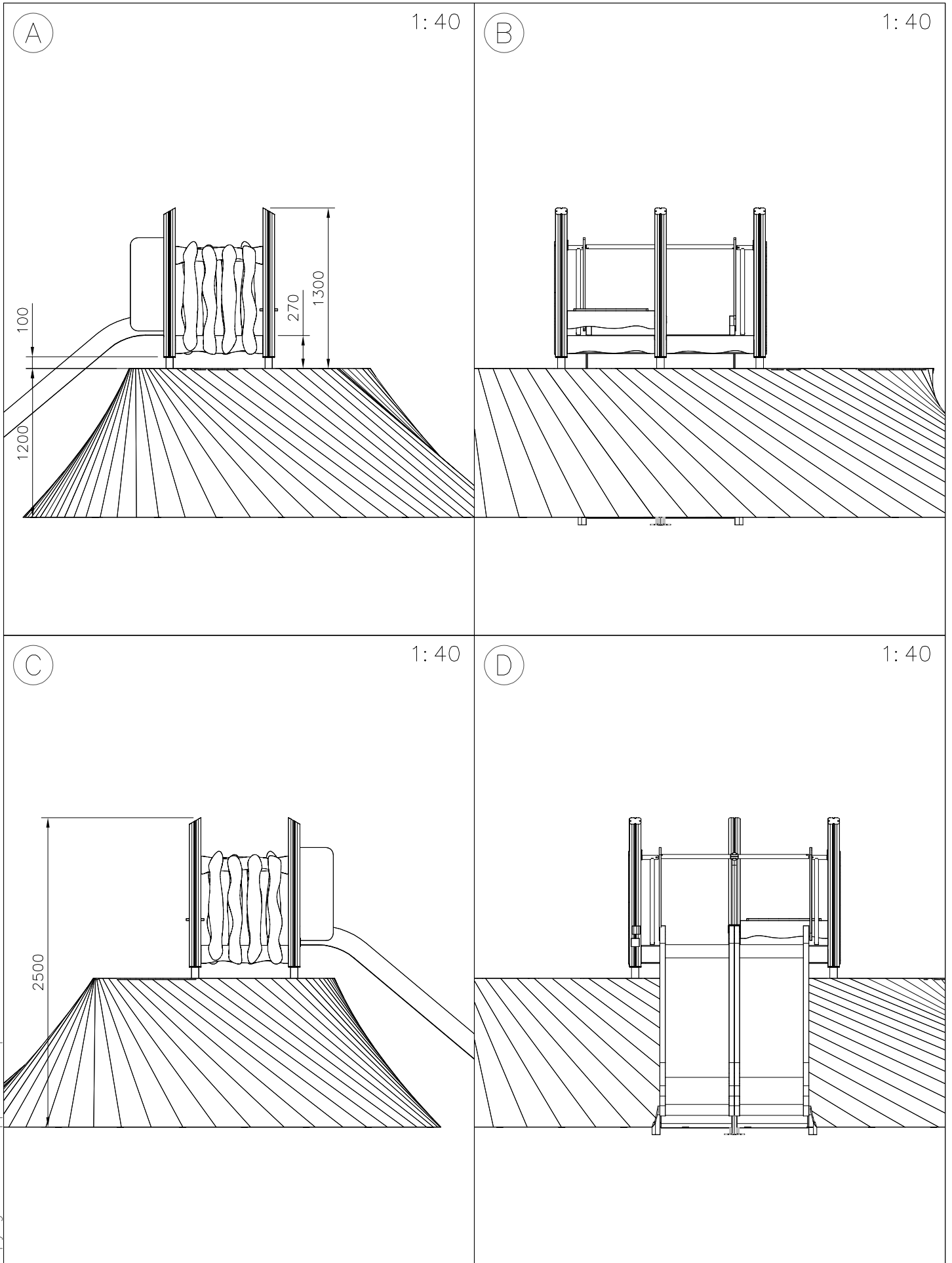

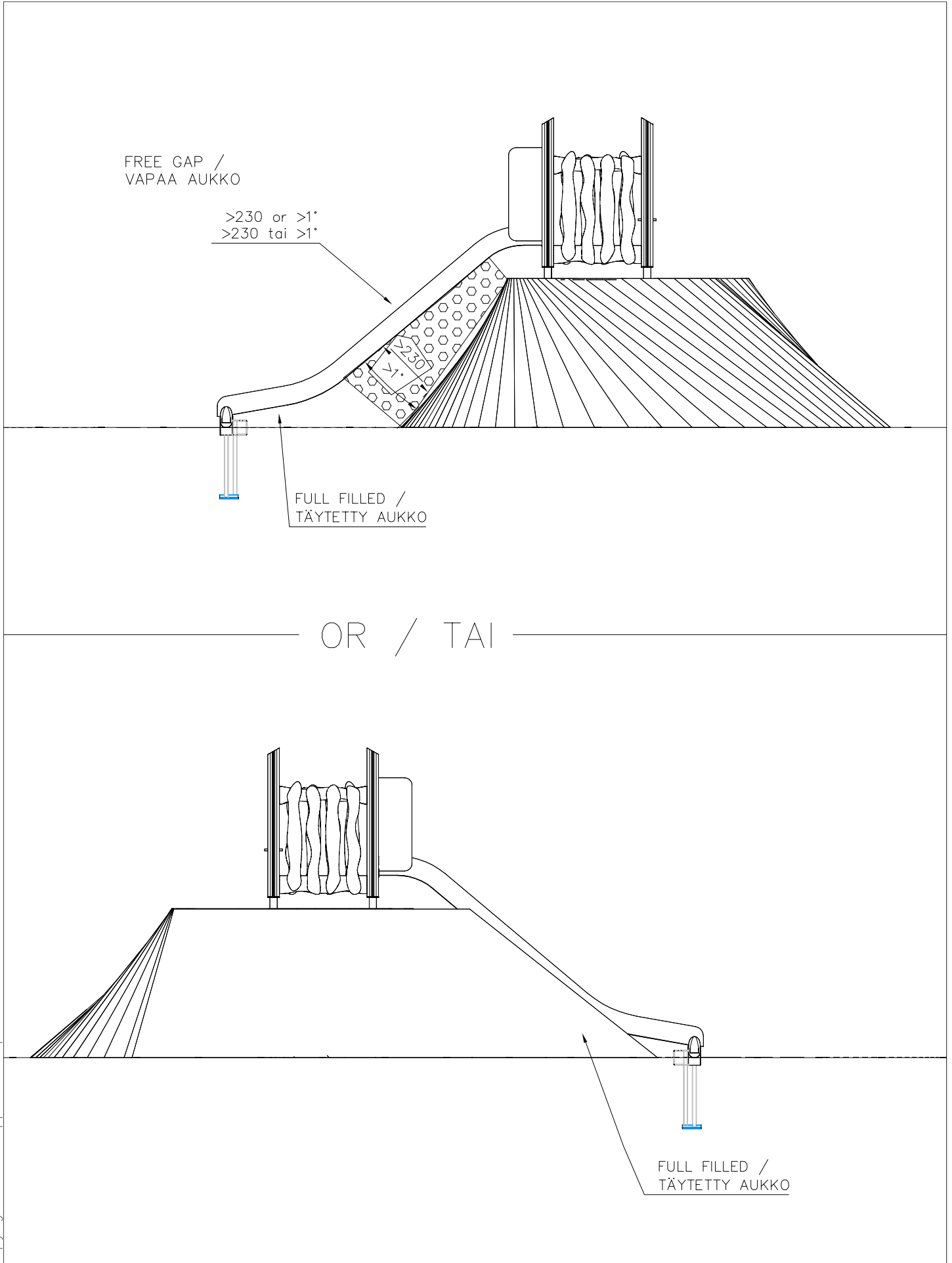



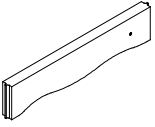
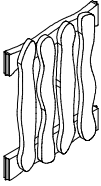

- - - Falling Space 27 m<sup>2</sup>  
 Max Falling Height 1000 mm

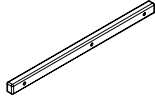
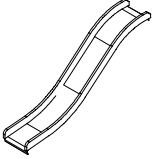

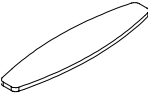
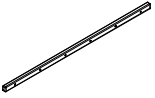
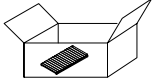

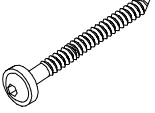
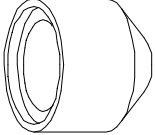
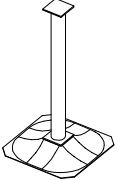
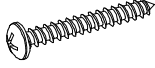
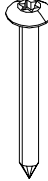

DATE: 4.12.2024

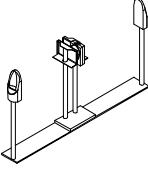
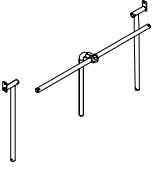
702286	PCS 2	705211-001	PCS 3	705230-001	PCS 2	706371-707	PCS 2	706443	PCS 2	706450	PCS 2
											
65x65		45x145x715				15x345x750		32x45x702		600x1381x2685	
706453	PCS 1	707437	PCS 1	707440	PCS 1	708767-001	PCS 1	711190	PCS 1	711192	PCS 1
											
15x145x600		32x45x1502				45x145x1525		750x770		750x770	
711371-001	PCS 5	903093	PCS 16	905104	PCS 20	909521	PCS 5	980114	PCS 8	980123	PCS 4
											
93x93x1200		Ø8x90		M10				Ø4x20		Ø7x60	
A10874	PCS 1	A10875-216	PCS 1		PCS		PCS		PCS		PCS
											
	PCS		PCS		PCS		PCS		PCS		PCS
	PCS		PCS		PCS		PCS		PCS		PCS
	PCS		PCS		PCS		PCS		PCS		PCS