

LAPPSET®

FINNO

ASENNUSOHJE
MONTERINGSANSVISNING
INSTALLATION INSTRUCTION
AUFBAUANLEITUNG
NOTICE D'INSTALLATION

DATE: 29.11.2024

Q17018-1

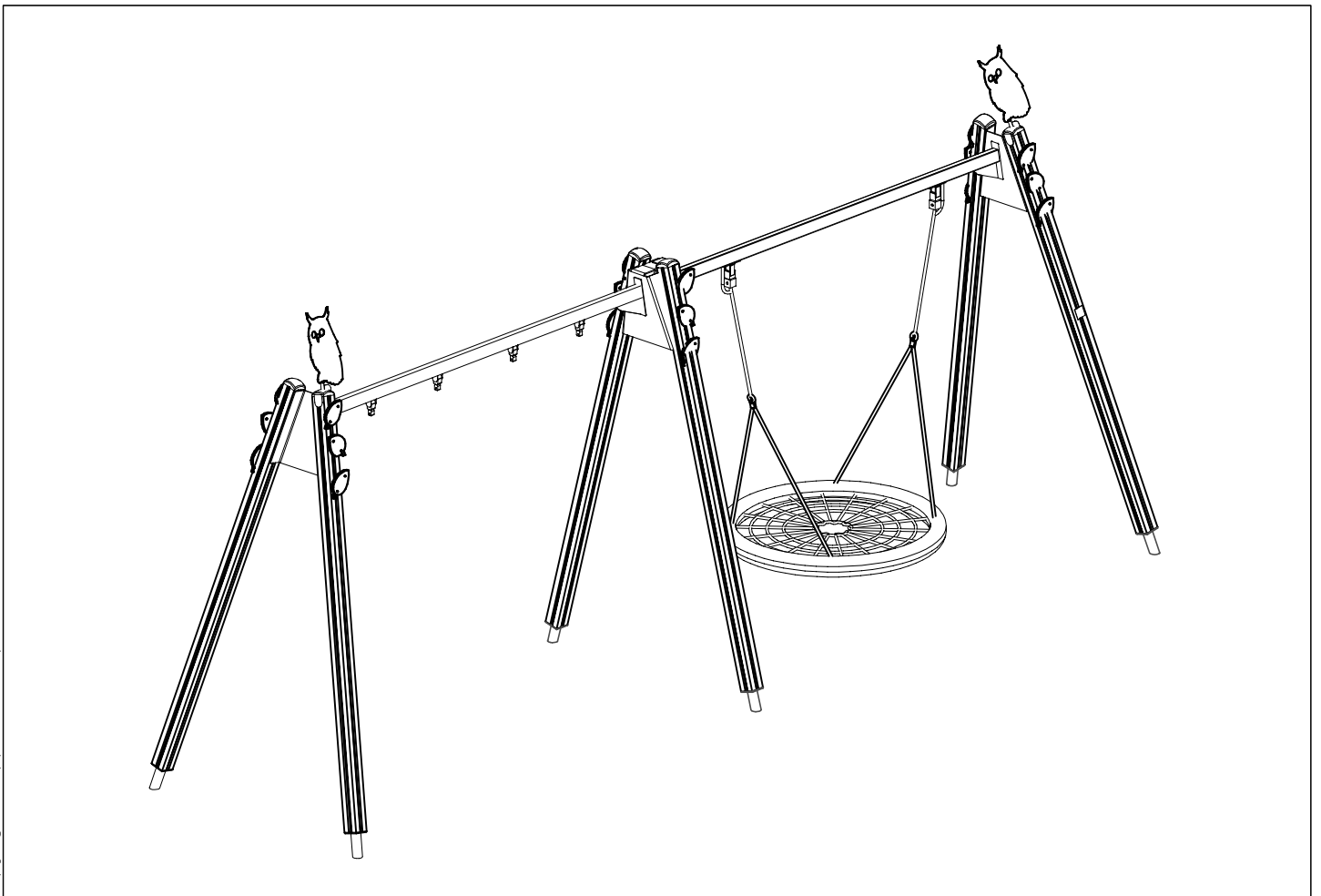

LAPPSET®

FINNO







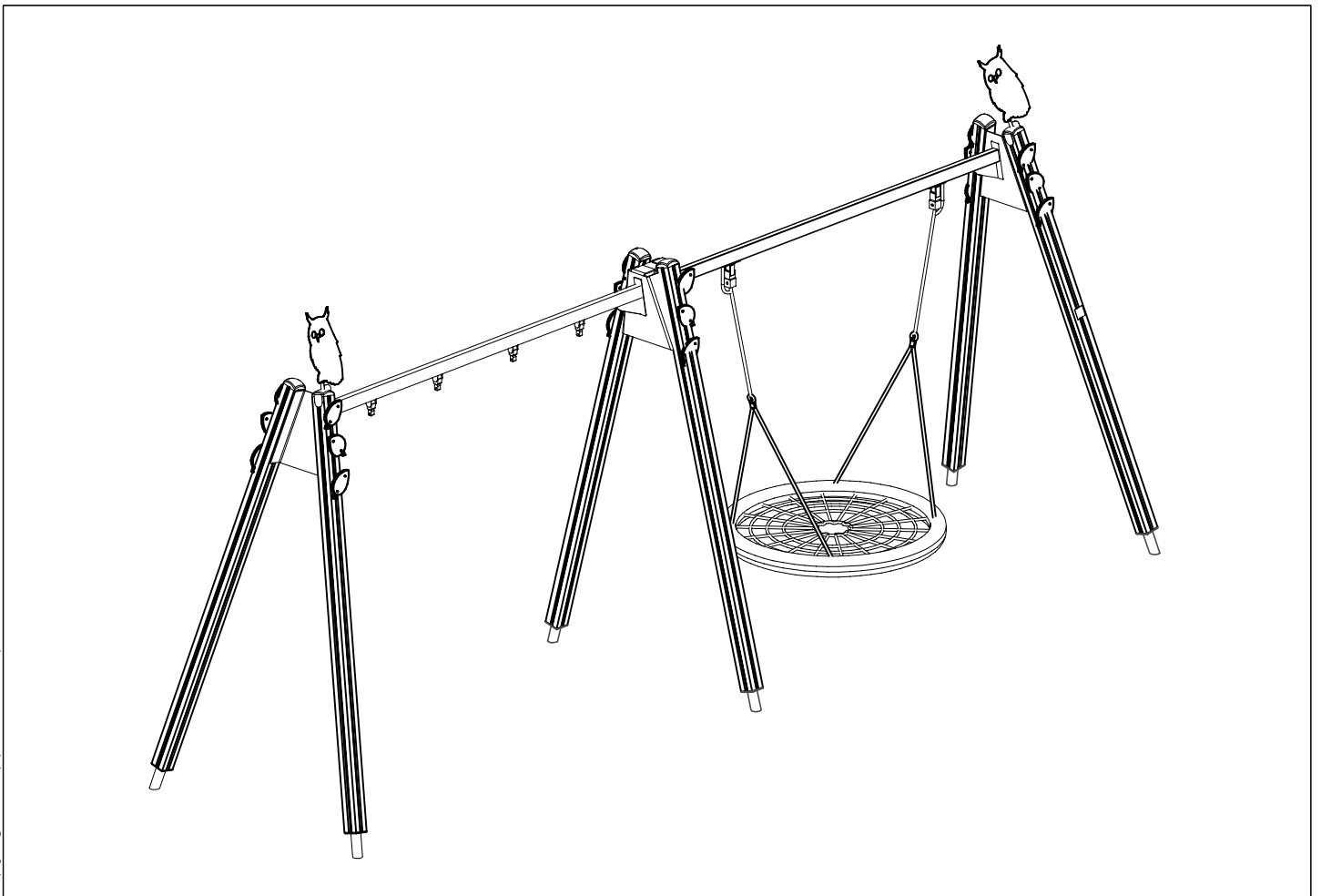



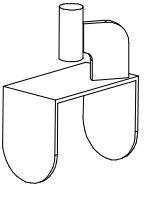
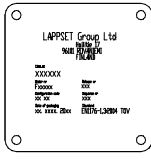



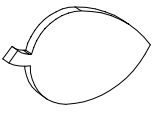

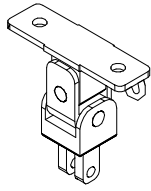

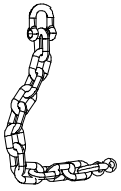
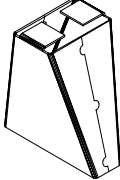
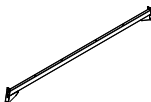
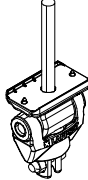
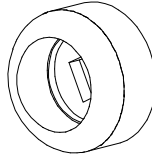
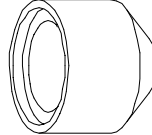
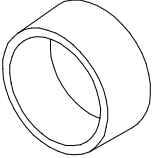
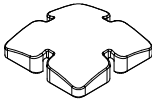
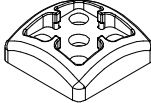
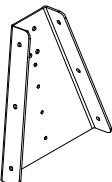

ASENNUSOHJE
MONTERINGSANSVISNING
INSTALLATION INSTRUCTION
AUFBAUANLEITUNG
NOTICE D'INSTALLATION

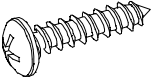
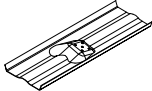
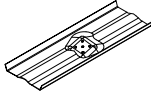
DATE: 29.11.2024

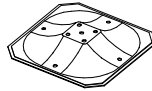
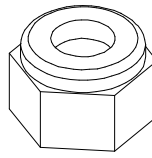
Q17018-1

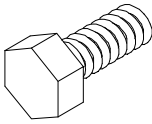
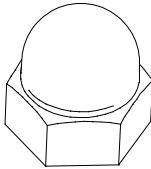

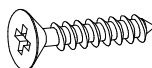
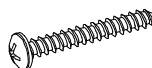
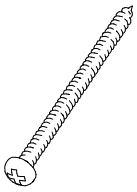
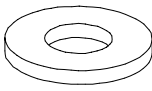
DATE: 29.11.2024

003894	PCS 2	702286	PCS 1	702533	PCS 1	703248	PCS 1	706564-602	PCS 6	708710	PCS 18
		 LAPPSET Group Ltd FINNO 65x65									
		65x65		118x78				L2650			
900965	PCS 8	901958	PCS 2	901959	PCS 1	902234	PCS 4	903149	PCS 8	903577	PCS 2
											
M10				L2940		M12		M12x30			
904317	PCS 1	904333	PCS 1	904904	PCS 4	905090	PCS 18	905104	PCS 24	905115	PCS 18
											
		L2940				Ø45		M10		Ø30	
905138	PCS 6	905196	PCS 6	905991	PCS 2	906499	PCS 4	909347	PCS 18	909506	PCS 4
											
						M12x110		M12x35		Ø3.5x13	
909507	PCS 2	909508	PCS 2	909511	PCS 2	909519	PCS 2	909637	PCS 24	909638	PCS 64
											
L 1000		L 1000		L650		50x380x380		M10		Ø20/10.5	
909639	PCS 32	909644	PCS 8	911155	PCS 4	980110	PCS 36	980114	PCS 4	980131	PCS 24
											
M10x25		M12		L650		4x35		Ø4x20		Ø6x60	
980154	PCS 42	999561	PCS 1	PM0216	PCS 2						
		 GLUE 4101 ergo 10 g									
Ø24x13		10g									

EN/AS Impact Area 43.1 m²

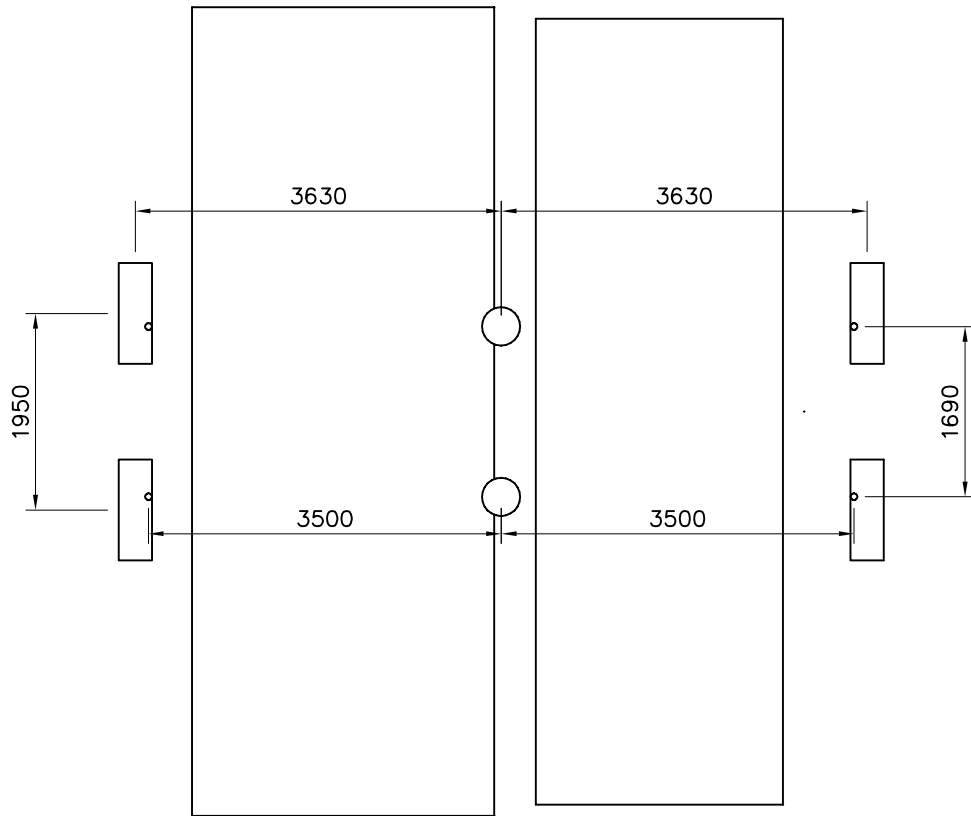
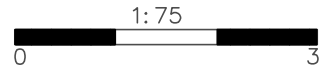

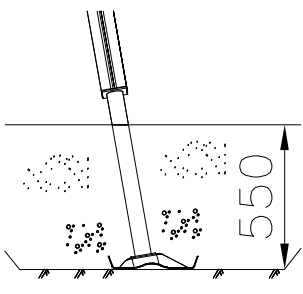
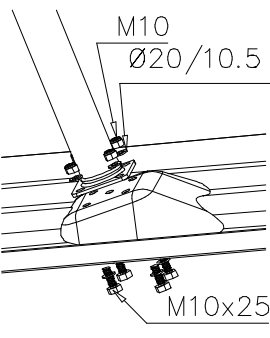
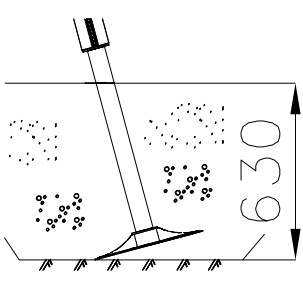
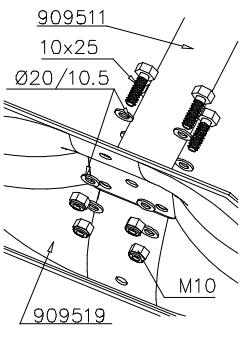
- EN/AS Impact Area 43.1 m²
- Falling Space 43.1 m²
Max Falling Height 1400 mm



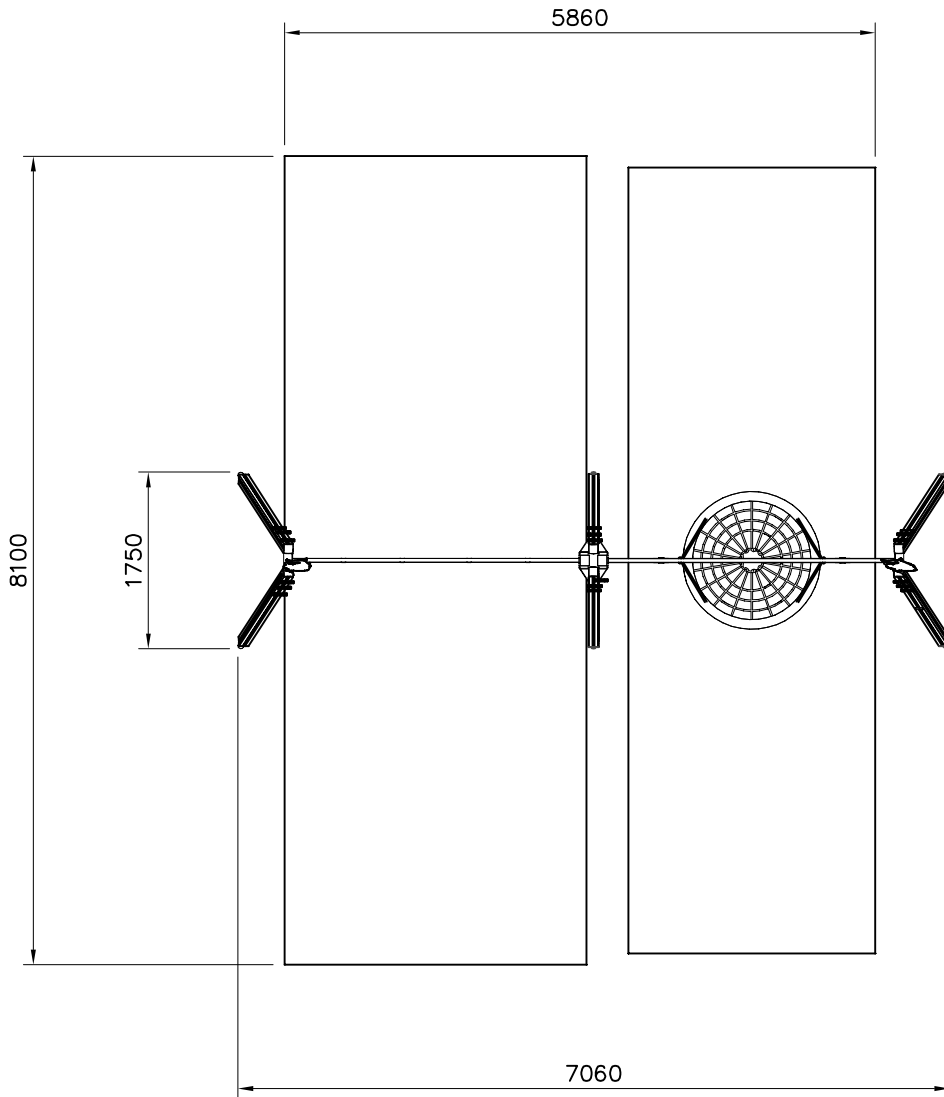
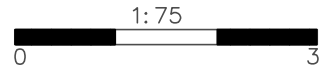

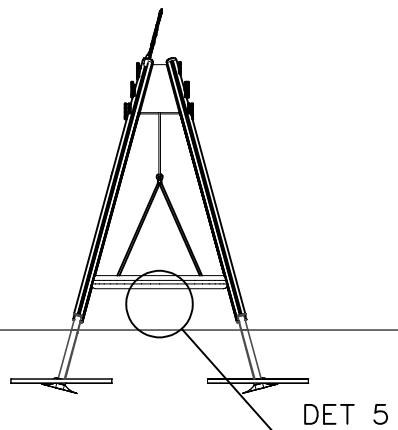
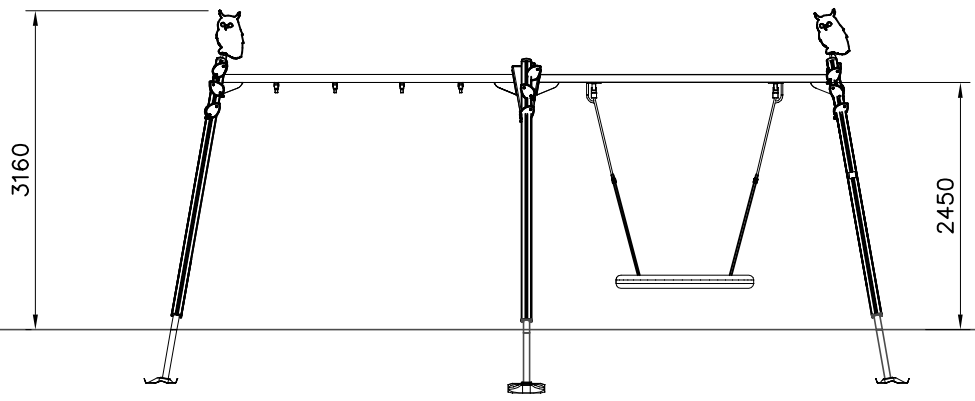

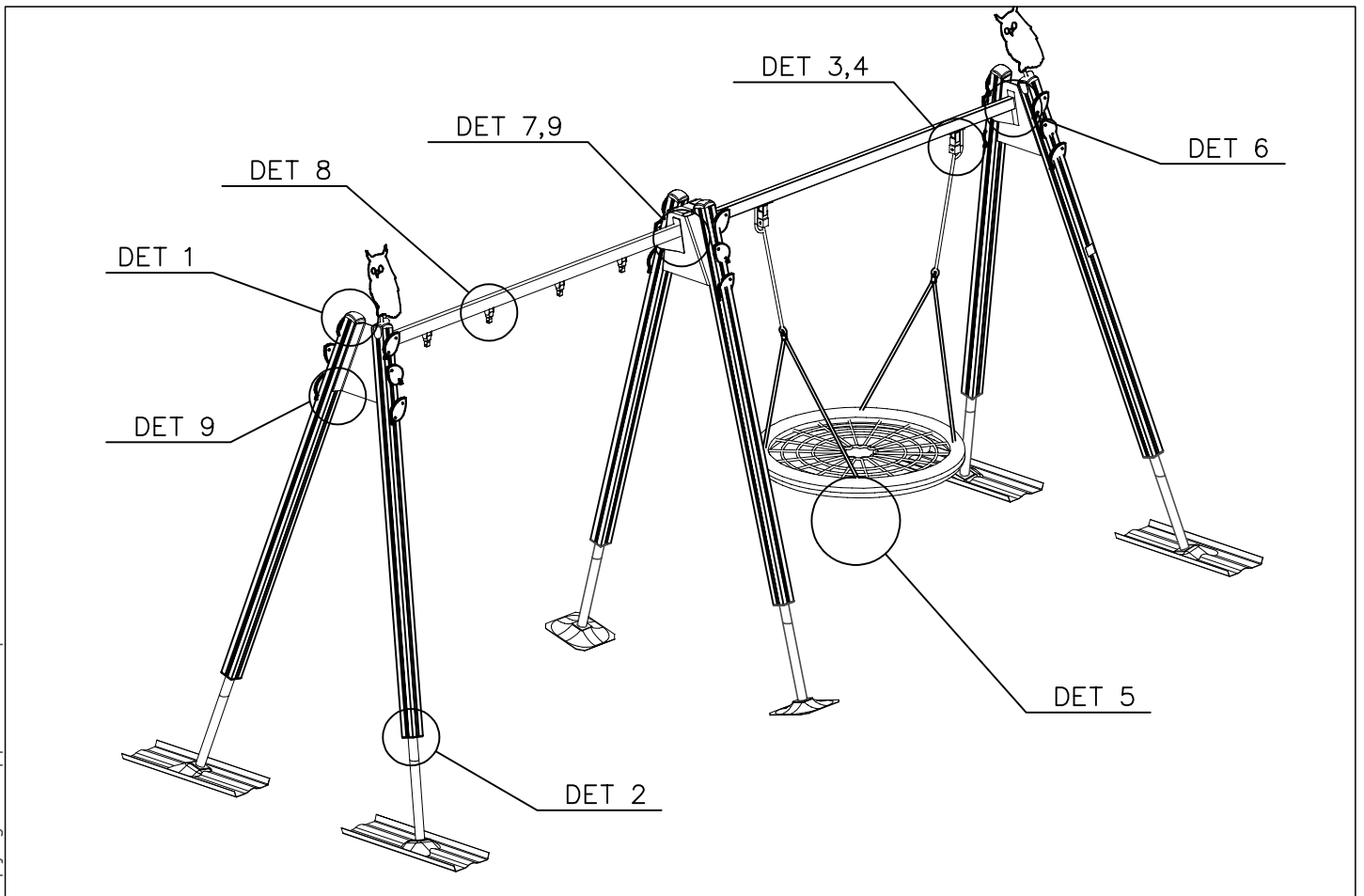
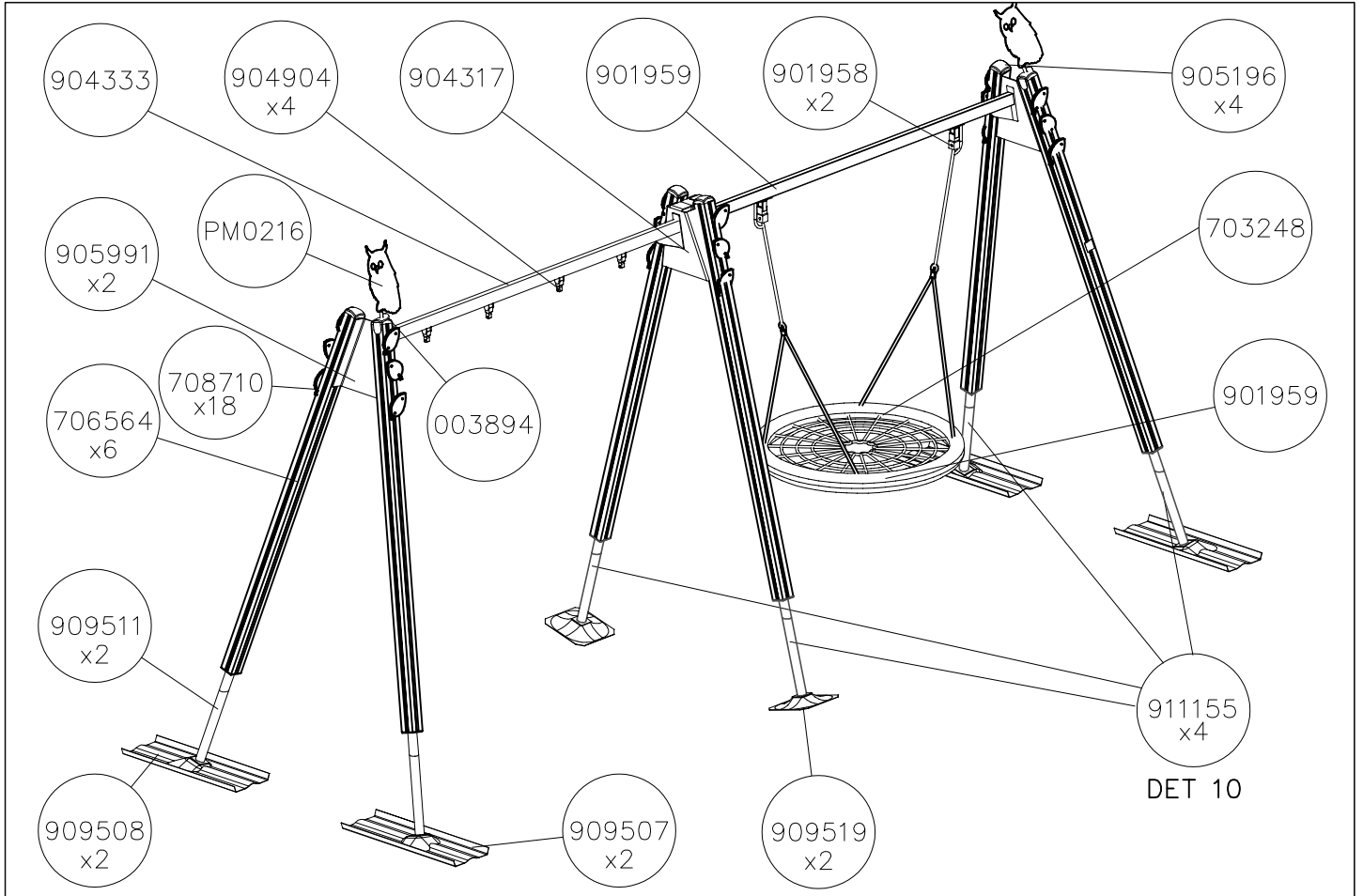
<p>DET 1</p> <p>6x60 980131</p>	<p>DET 2</p> <p>M10 905104 909521</p>	<p>DET 3</p> <p>901958 903577</p>	<p>DET 4</p> <p>M12x110 Ø24/13 901958 M8x35 Ø24/13 M12 M8 CUT EXTRA CHAIN</p>
<p>DET 5</p> <p>>400</p>	<p>DET 6</p> <p>M12 → 80 Nm Ø24/13 M12 M12x30 M10x25 Ø20/10.5 M10 M10 → 45 Nm</p>	<p>DET 7</p> <p>904317</p>	<p>DET 8</p> <p>M12 980154 Ø24/13 904904</p>
<p>DET 9</p> <p>999561 GLUE Ø24/13 12x35 905115 905090</p>	<p>DET 10</p> <p>911155</p>		

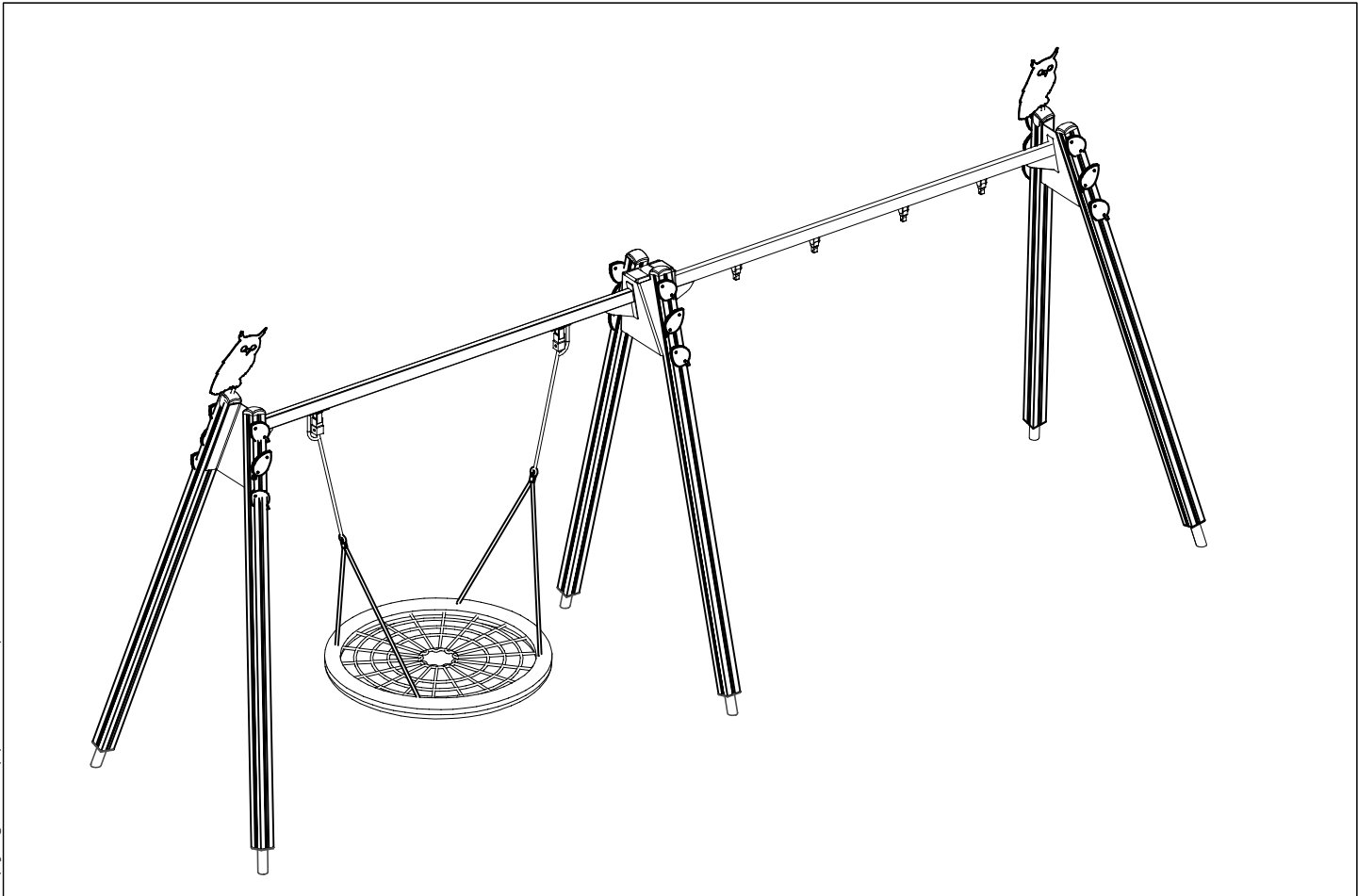
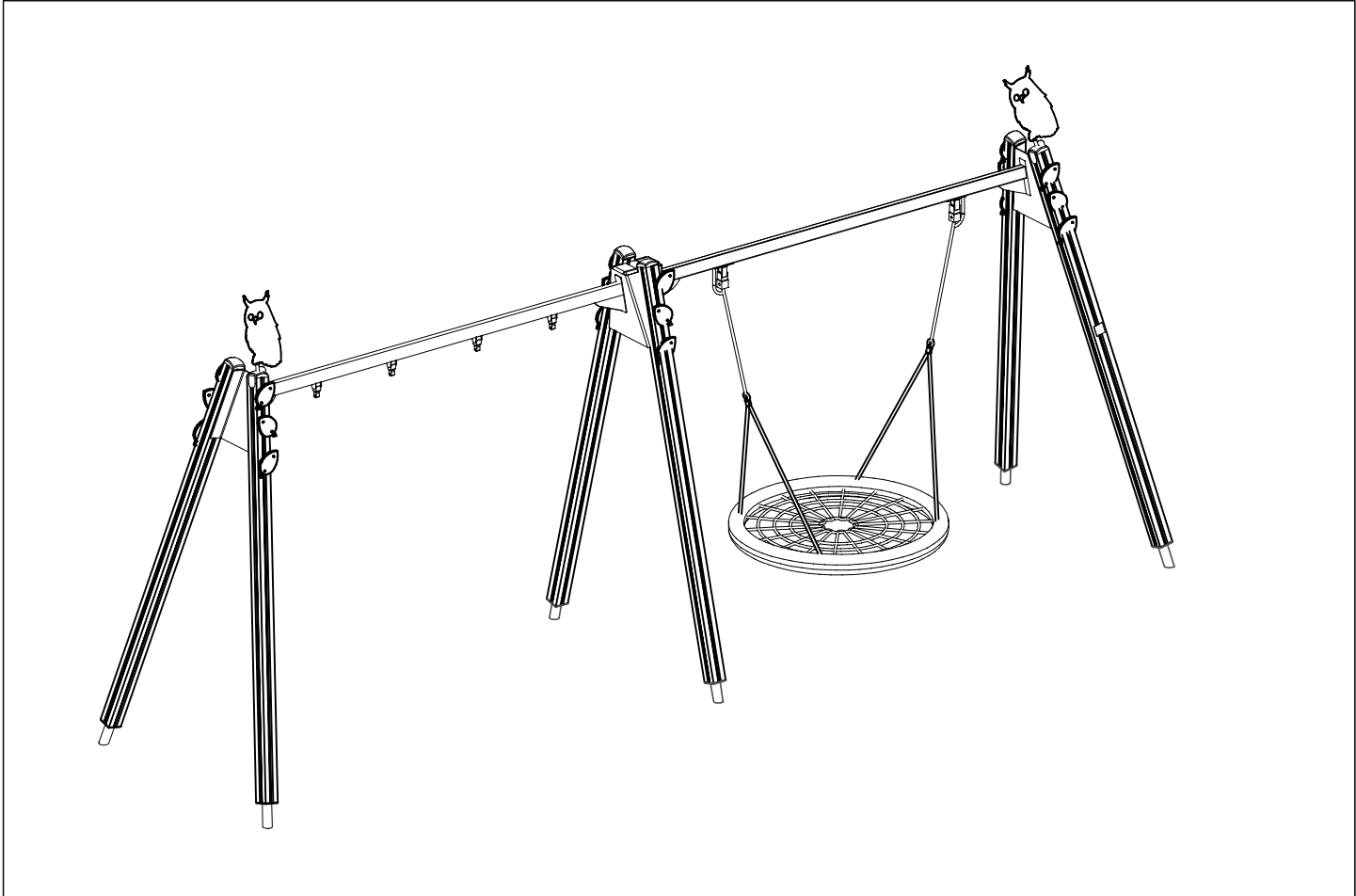

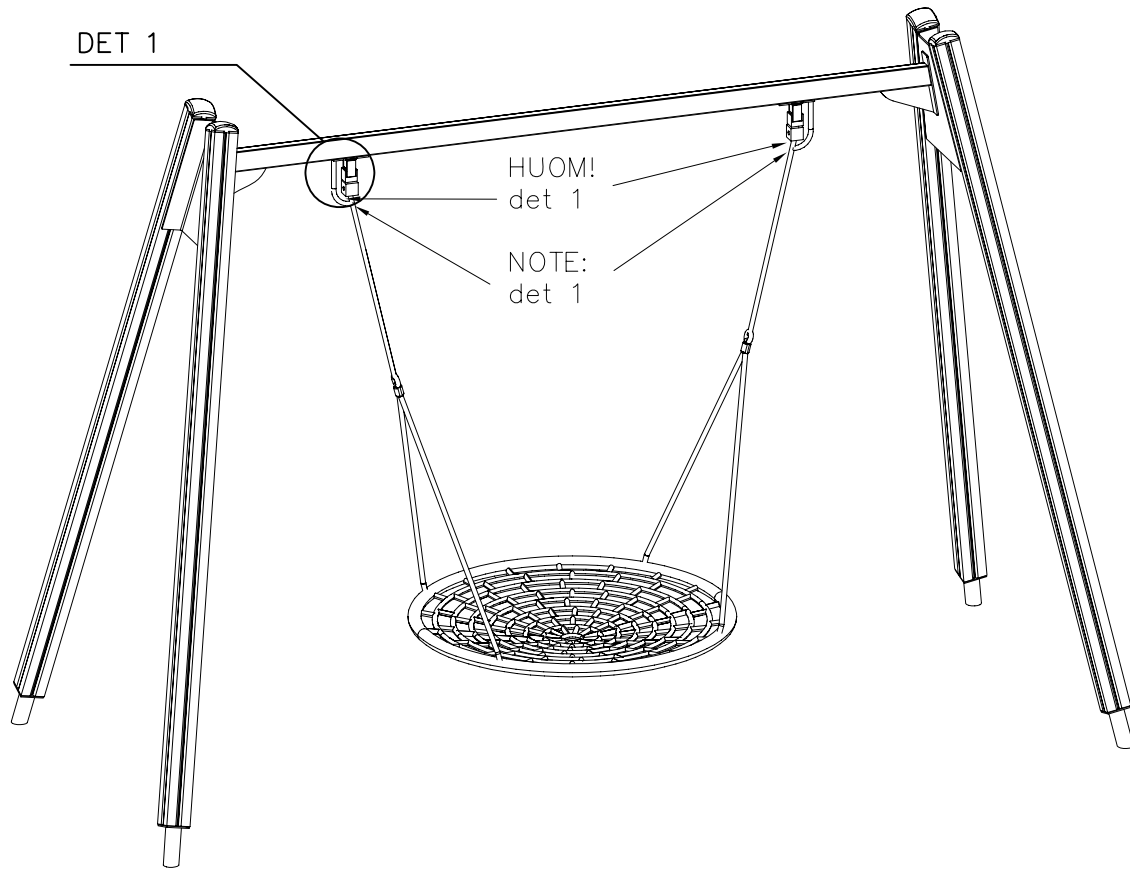

DET 1

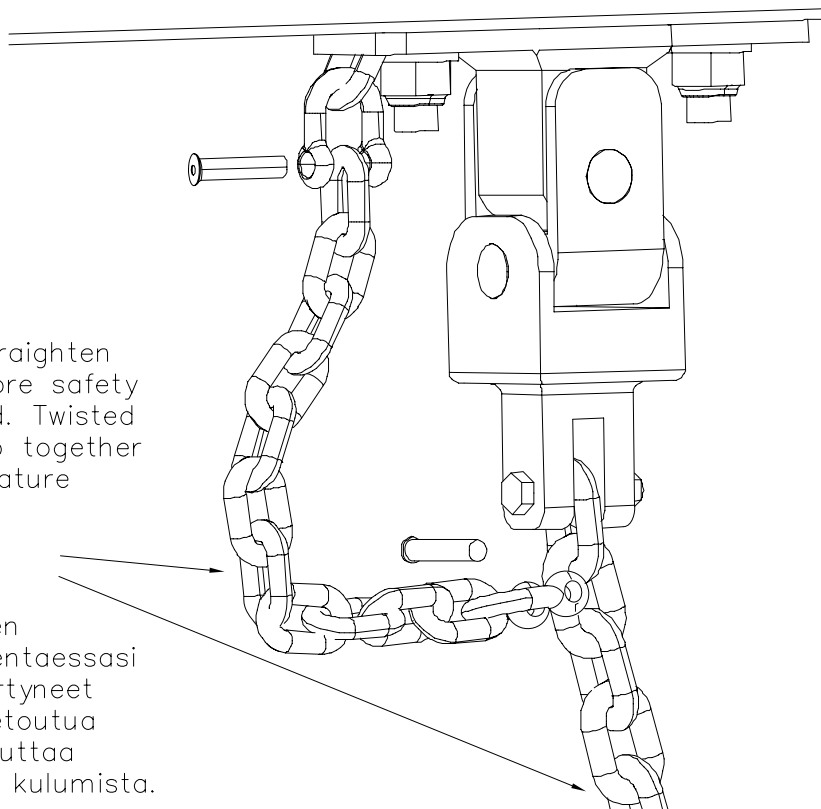

Note:
Make sure to straighten both chains before safety chain is installed. Twisted chains may wrap together and cause premature wear.

Huom!
Varmistu ketjujen suoruudesta asentaessasi turvaketjua. Kiertyneet ketjut voivat kietoutua toisiinsa ja aiheuttaa ketjujen nopeaa kulumista.

LAPPSET®
BETON FOUNDATION

FOOT

DATE: 27.10.2015

1(1)

② 905104	PCS		PCS
	4		
 M10	PCS		PCS



905104

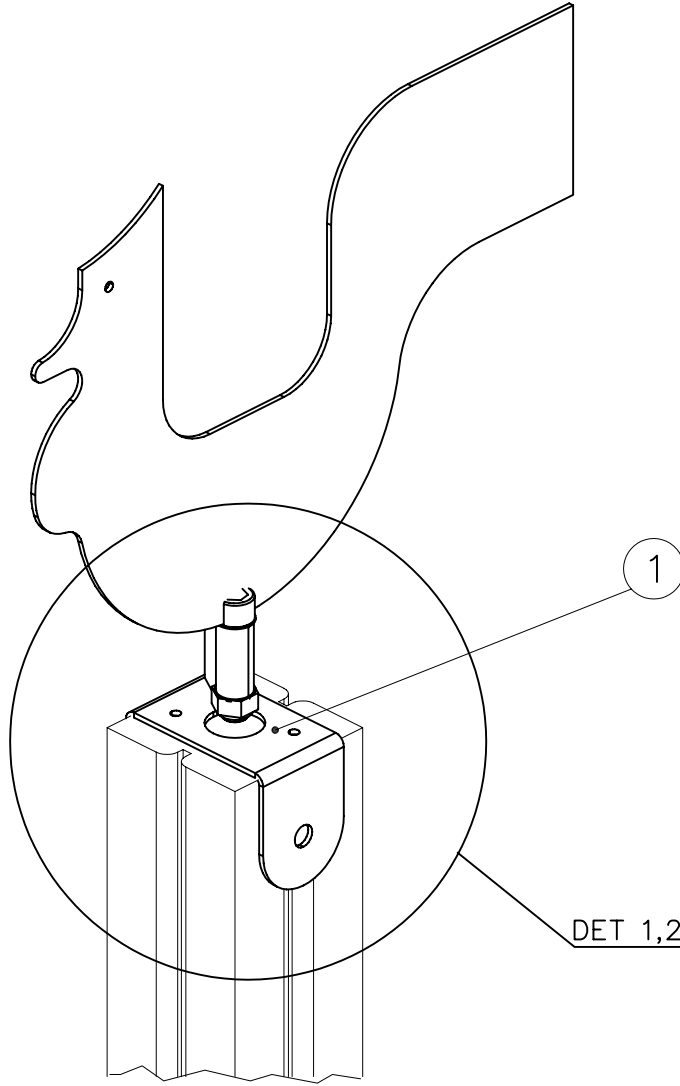

① 907082	PCS 1	② 900240	PCS 2
		Ø8x70	
③ 980106	PCS 2		PCS
5x40			
	PCS		PCS
	PCS		PCS
	PCS		PCS
○ 007120	PCS 1	○ 007121	PCS 1
○ 007122	PCS 1	○ 007123	PCS 1
○ 007124	PCS 1	○ 007125	PCS 1

DET 1

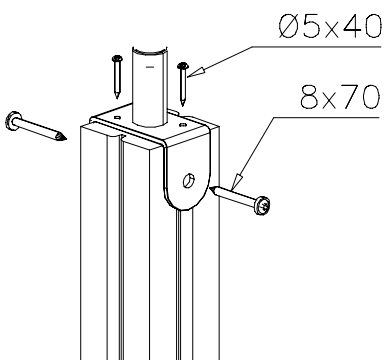

DET 2

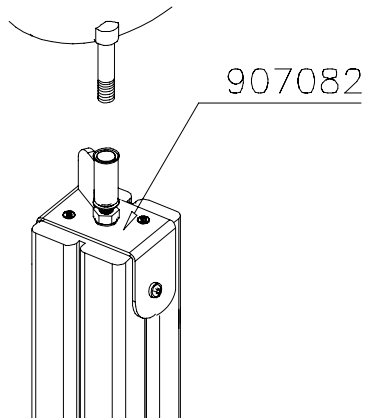

**Tuotekyltti tulee tuotteen mukana yhdellä seuraavista tavoista:****1) Metallinen tuotekyltti ja kiinnitysruuvit**

- Kiinnitä tuotekyltti ruuveilla tolppaan noin 2 metrin korkeuteen kuvan 1 mukaisesti.

2) Tuotekylttitarra

- Puhdista maalattu metalli- tai vaneripinta pölystä ja kosteudesta. Liimaa tarra kuvan 2 mukaisesti.
- Huom. Älä kiinnitä tarraa karheapintaiseen laminaattiin tai maalattuun puuhun.

Vår produktmärkning levereras på ett av följande sätt:**1) Produktskylt i metall**

- Fäst skylten med de medföljande skruvarna

2) Självhäftande produktetikett

- Rengör den pulverlackerade metallytan eller laminatyten så att den blir fri från smuts och fukt. Fäst etiketten enligt fig. 2.
- Obs! Fäst ej etiketten på detaljer med skrovlig yta eller på målat trä.

Product label is delivered by one of following ways:**1) Metal product label and screws**

- Fasten the label with screws.

2) Label sticker

- Clean the painted metal or plywood surface from dirt and moisture. Fasten the sticker as shown in the figure 2.
- Note. Do not attach the sticker to rough surfaced laminate or painted wood.

La plaque d'informations produit est livrée sous l'une de ces 3 formes :**1) Plaque métallique et vis**

- Fixez la plaque à l'aide des vis.

2) Etiquette autocollante

- Avant de coller l'étiquette, nettoyez le composant métallique peint ou la plaque de contreplaqué, de toute saleté. La surface doit être sèche (voir image 2).
- Attention, ne pas coller l'étiquette sur une surface lamellé-collée irrégulière ou sur du bois peint.

Die Auslieferung des Produktaufklebers erfolgt auf eine dieser Arten:**1) Produkt-Schild aus Metall incl. Schrauben**

- Die Befestigung des Schildes erfolgt mittels der Schrauben.

2) Aufkleber

- Entfernen Sie zunächst Schmutz und Feuchtigkeit vom lackierten Metall bzw. von der Holzoberfläche und bringen Sie den Aufkleber wie im Bild oben rechts beschrieben auf den gesäuberten Untergrund auf.
- Beachten Sie: Bringen Sie den Aufkleber nicht auf raues laminiertes oder lackiertes Holz an.