

LAPPSET®

ARENA



ASENNUSOHJE
MONTERINGSANSVISNING
INSTALLATION INSTRUCTION
AUFBAUANLEITUNG
NOTICE D'INSTALLATION

DATE: 17.4.2025

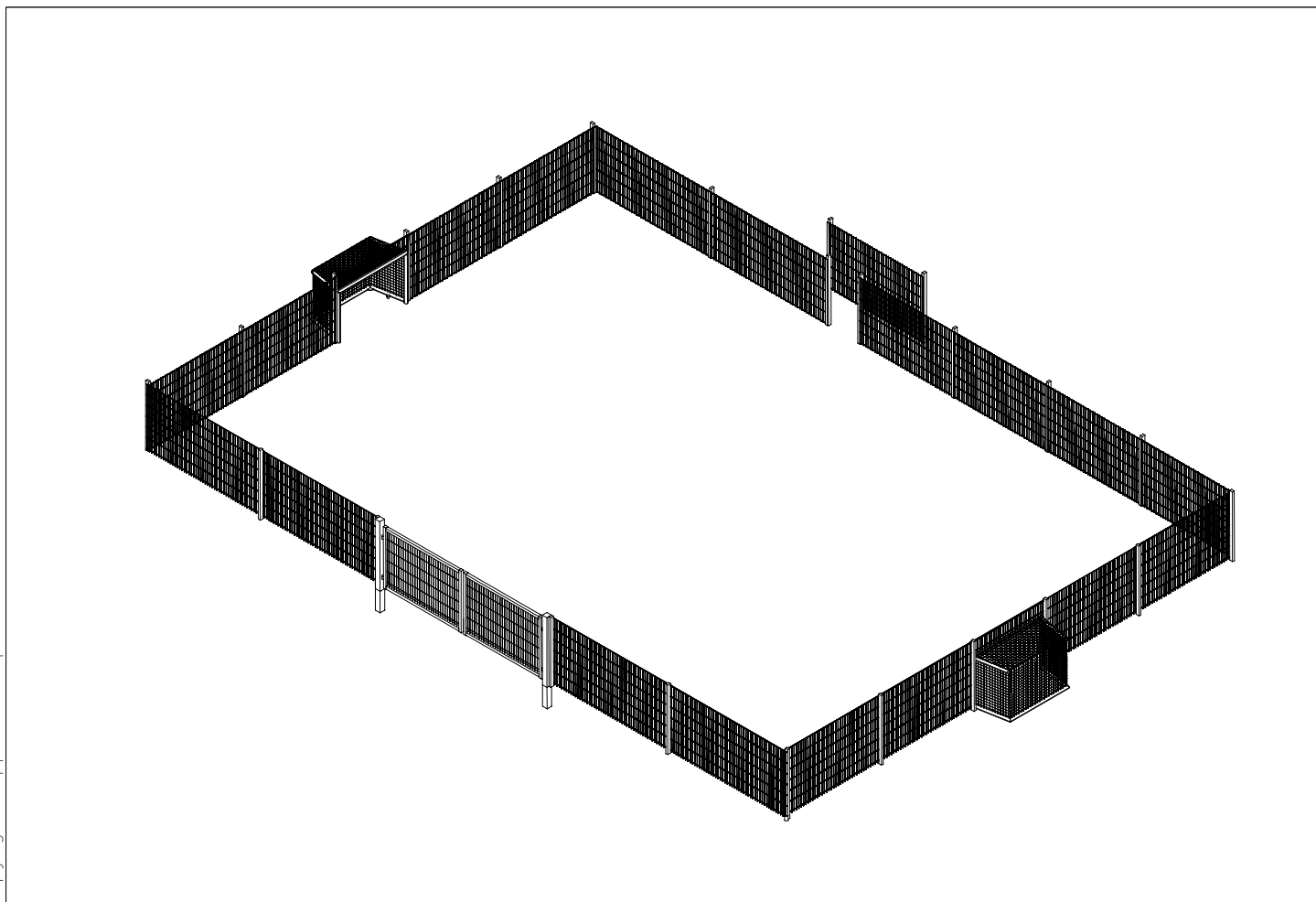
Q18640

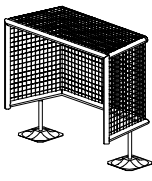
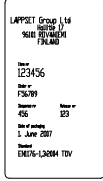
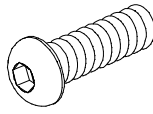
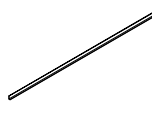
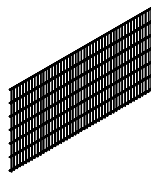
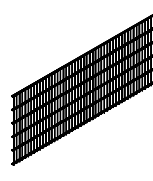

DATE: 17.4.2025

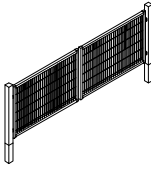
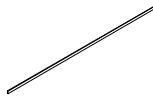
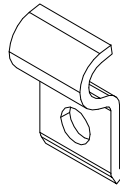
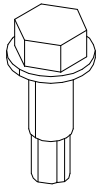
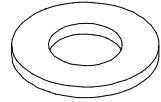
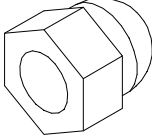
080950  90x50	PCS 2	702341  90x50	PCS 1	905827  M8x20	PCS 16	907023  12x30x1556	PCS 2	907350  1230x2500	PCS 19	907351  1030x2500	PCS 1
907359  40x60x1700	PCS 24	907651  1230x3500	PCS 1	907654  3x25x1556	PCS 2	907730  30x16x9	PCS 28	907731  Ø5,5x19	PCS 28	909256  Ø16/8.4	PCS 16
909633  M8	PCS 16		PCS		PCS		PCS		PCS		PCS
	PCS		PCS		PCS		PCS		PCS		PCS
	PCS		PCS		PCS		PCS		PCS		PCS
	PCS		PCS		PCS		PCS		PCS		PCS
	PCS		PCS		PCS		PCS		PCS		PCS

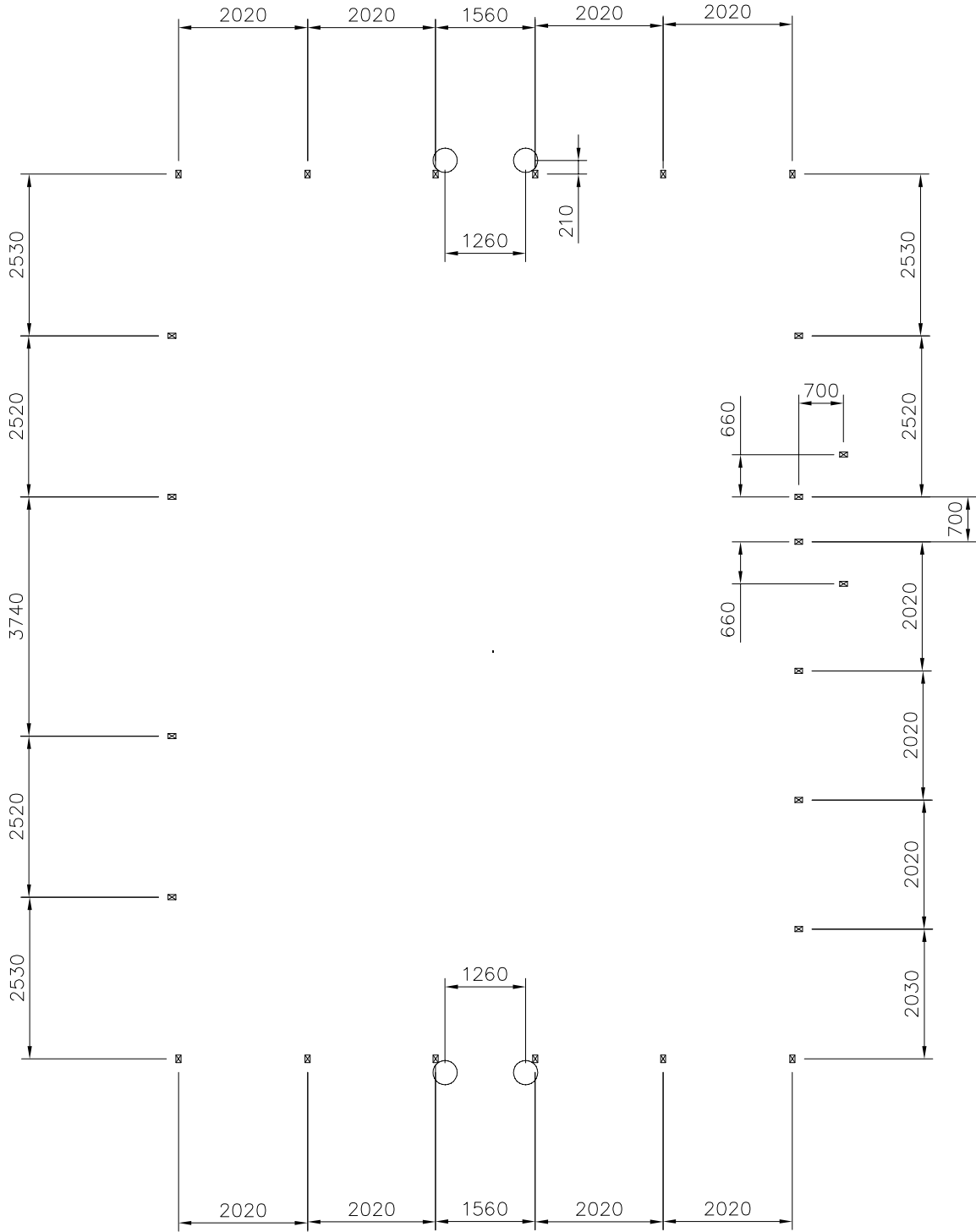

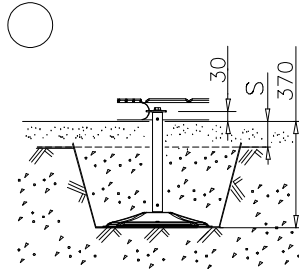
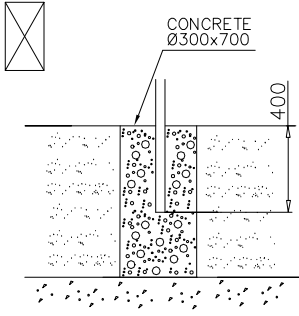

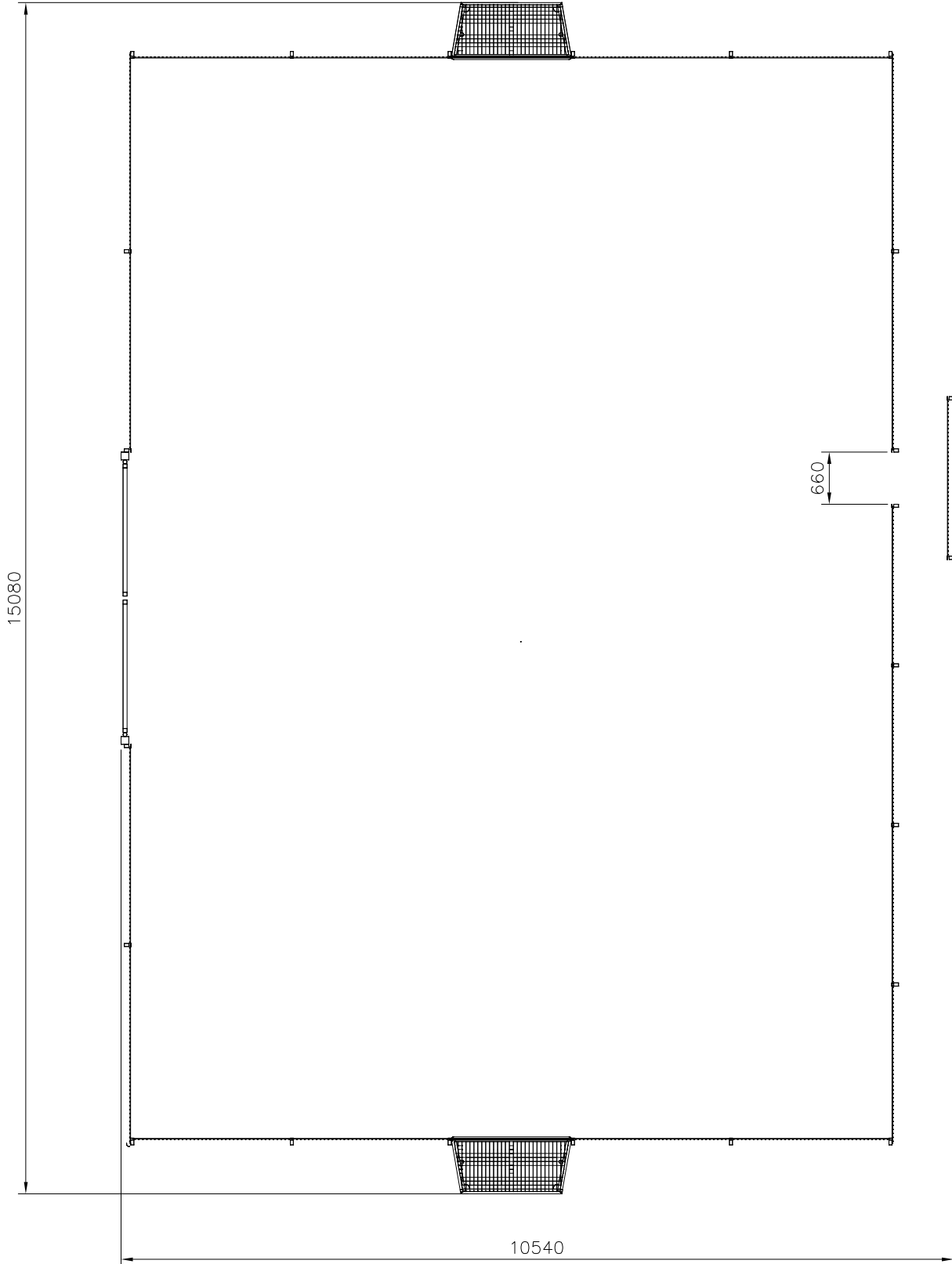
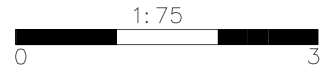

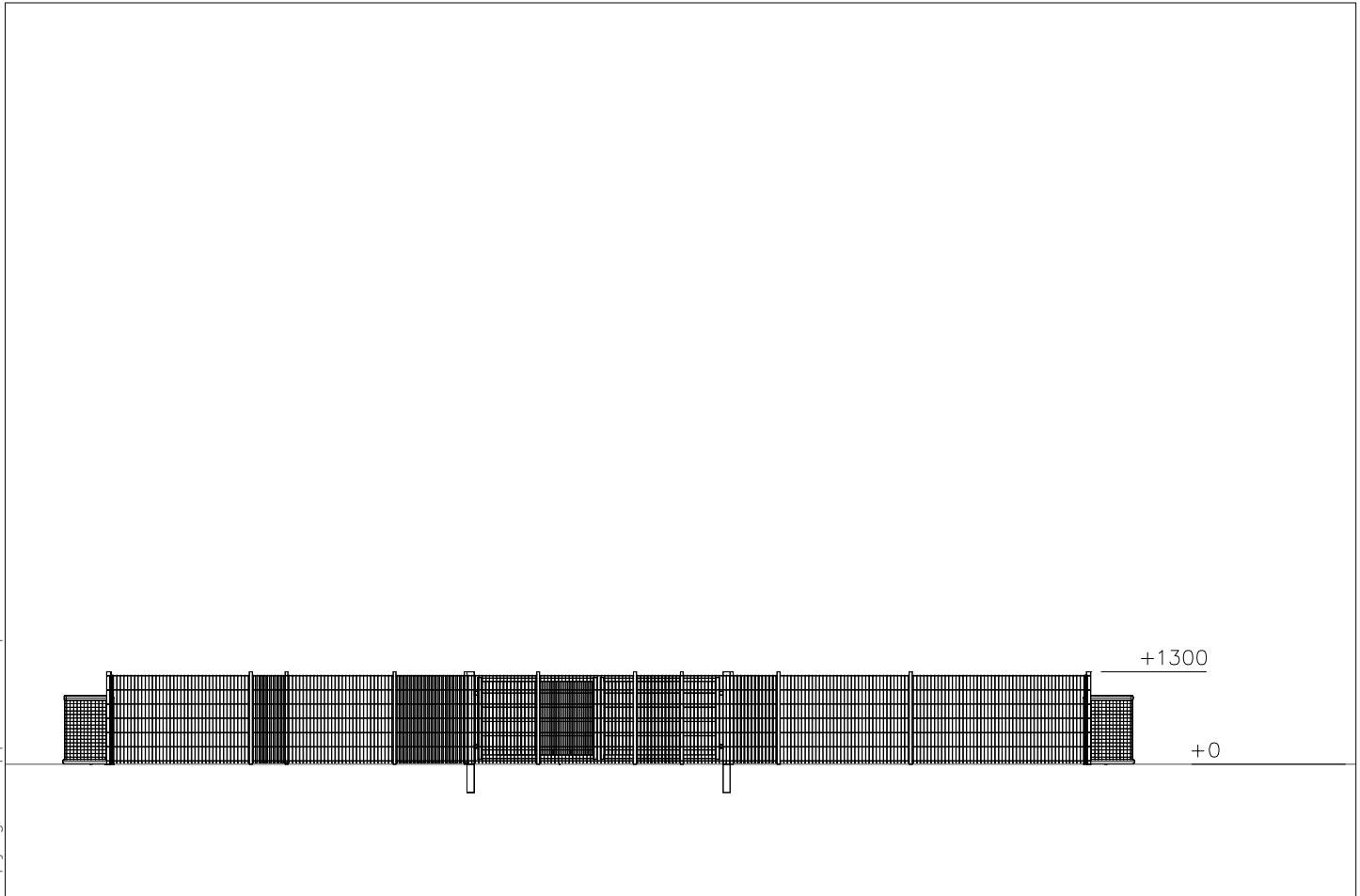
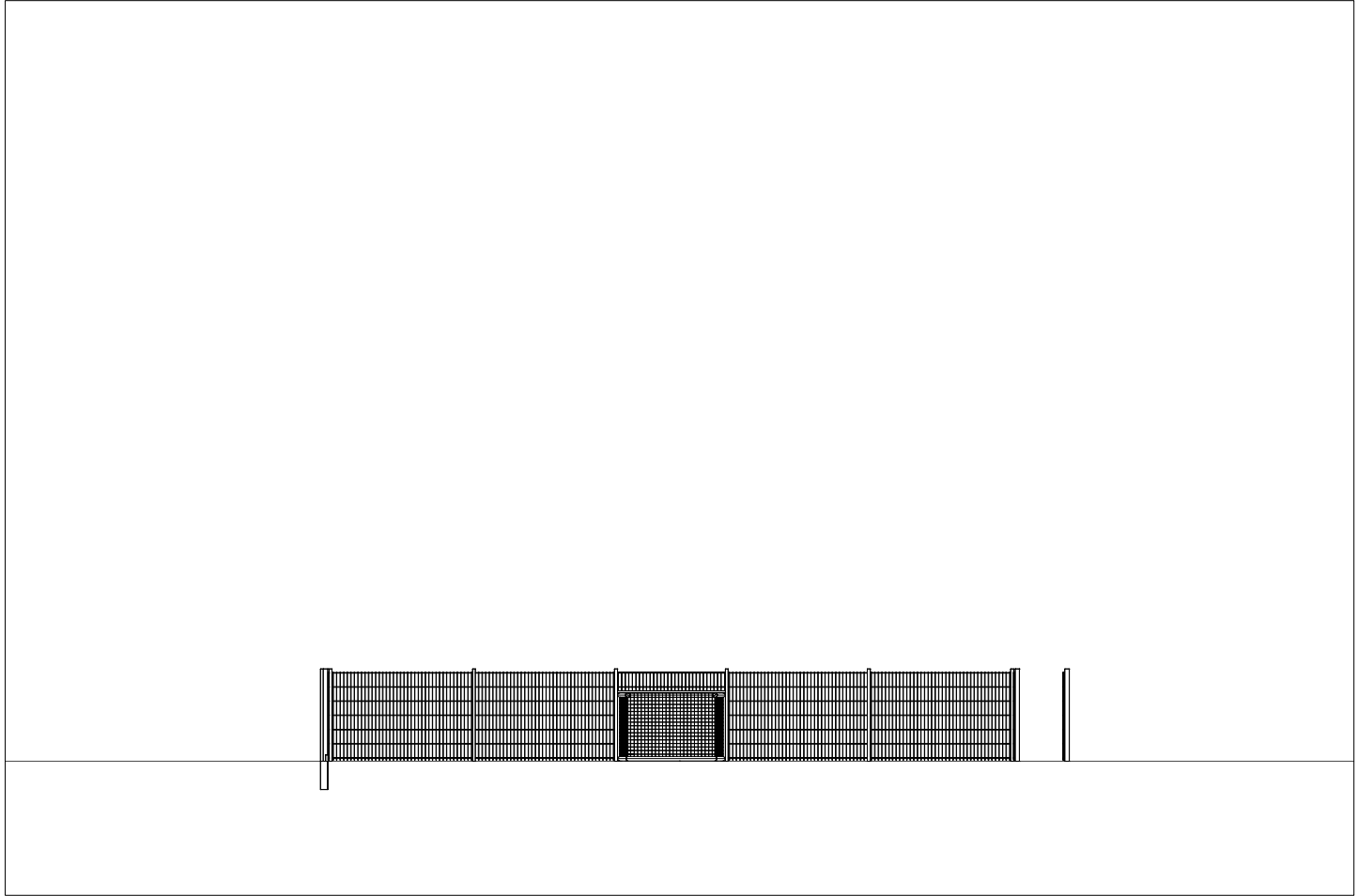

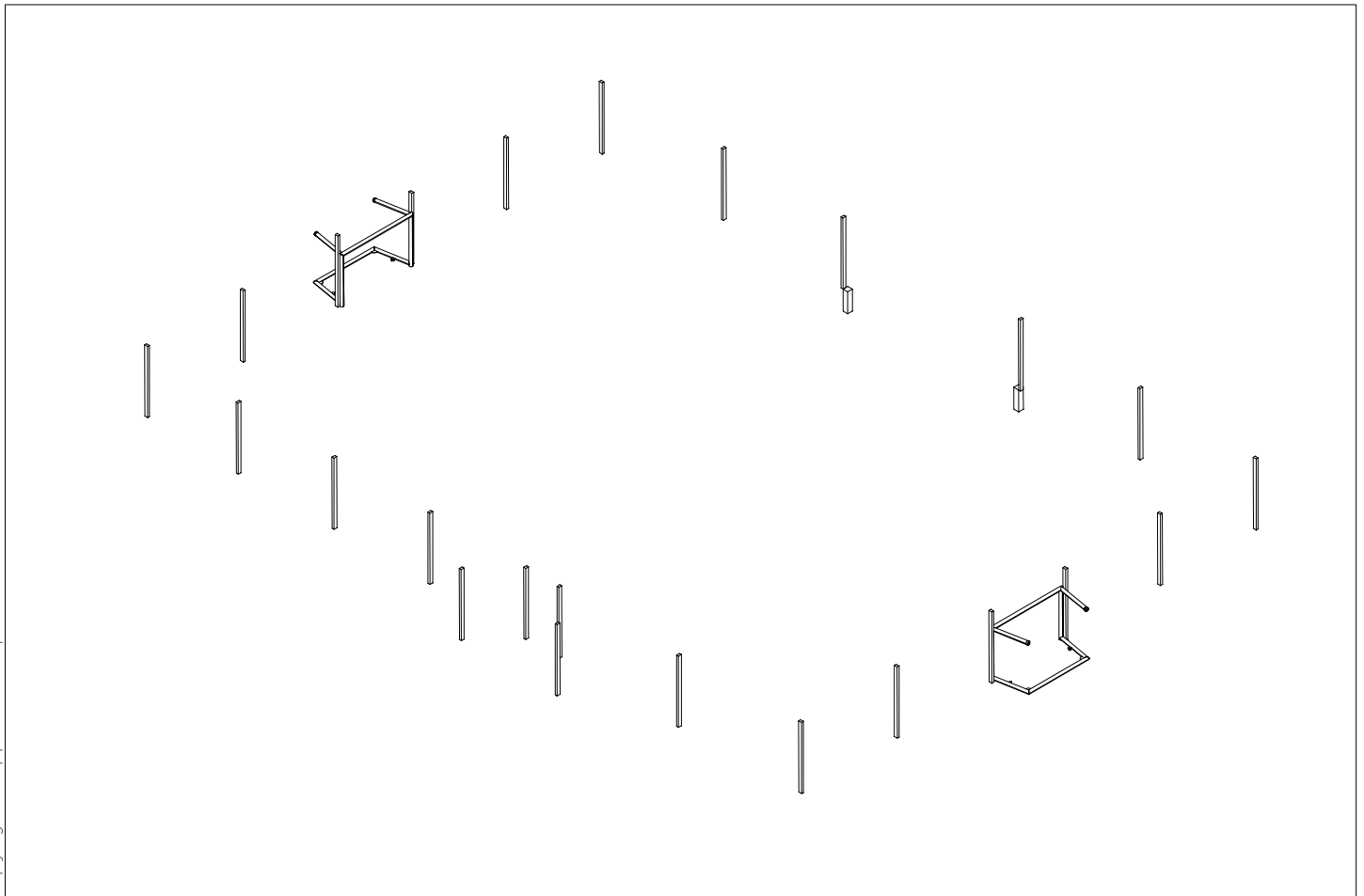
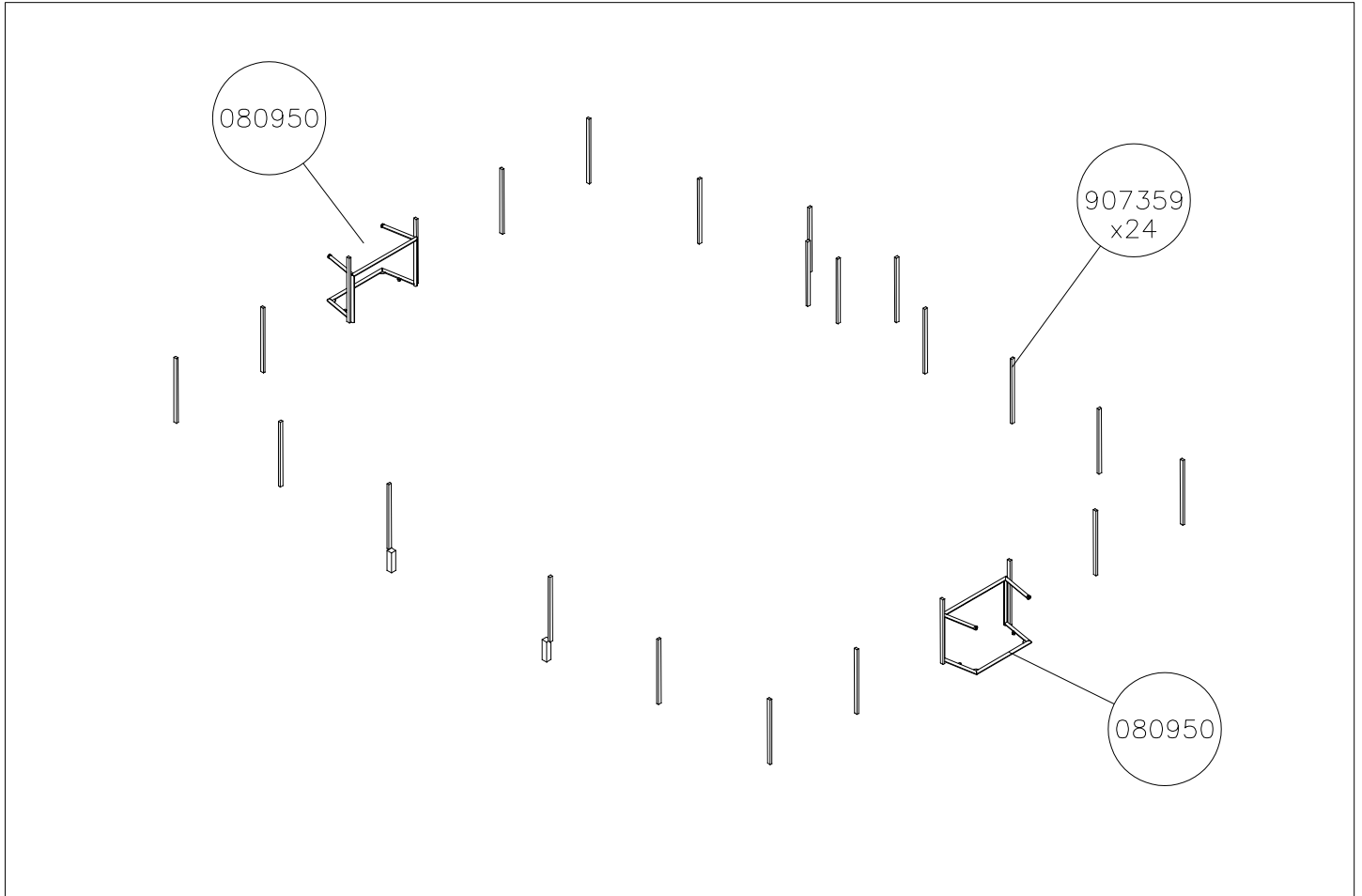

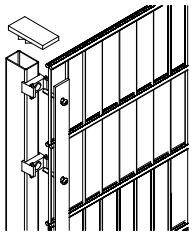
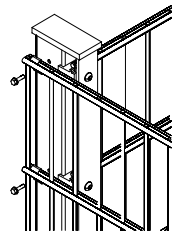
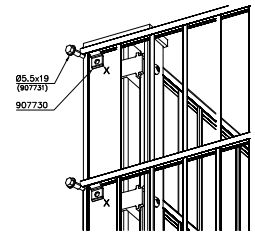
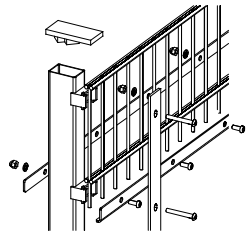
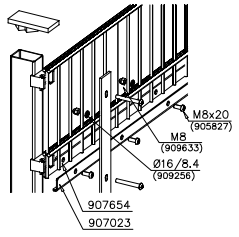
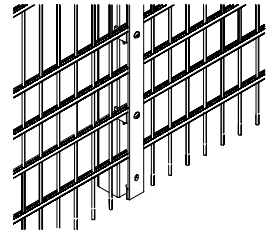
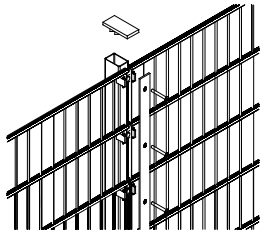
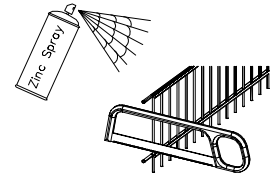

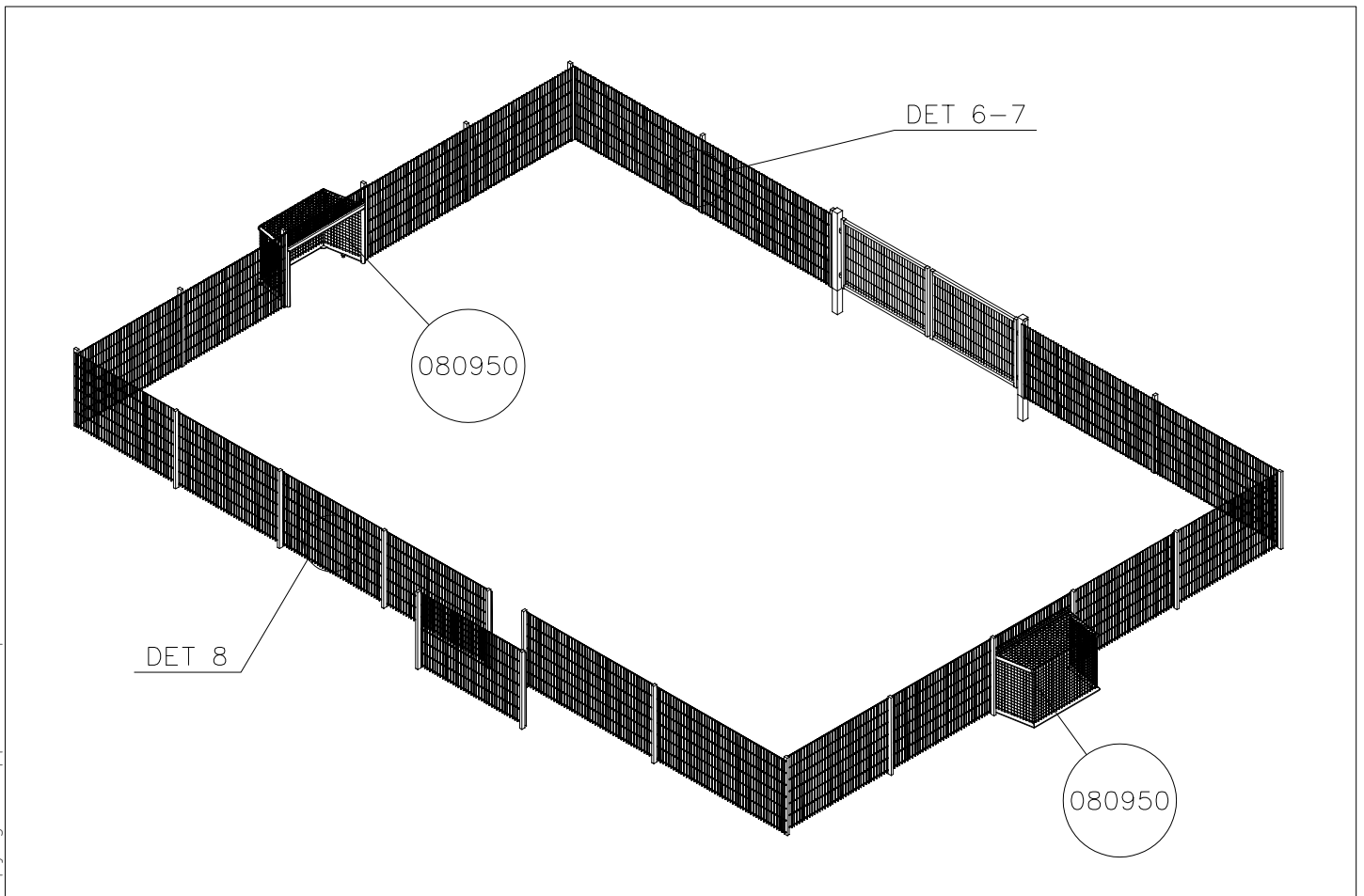
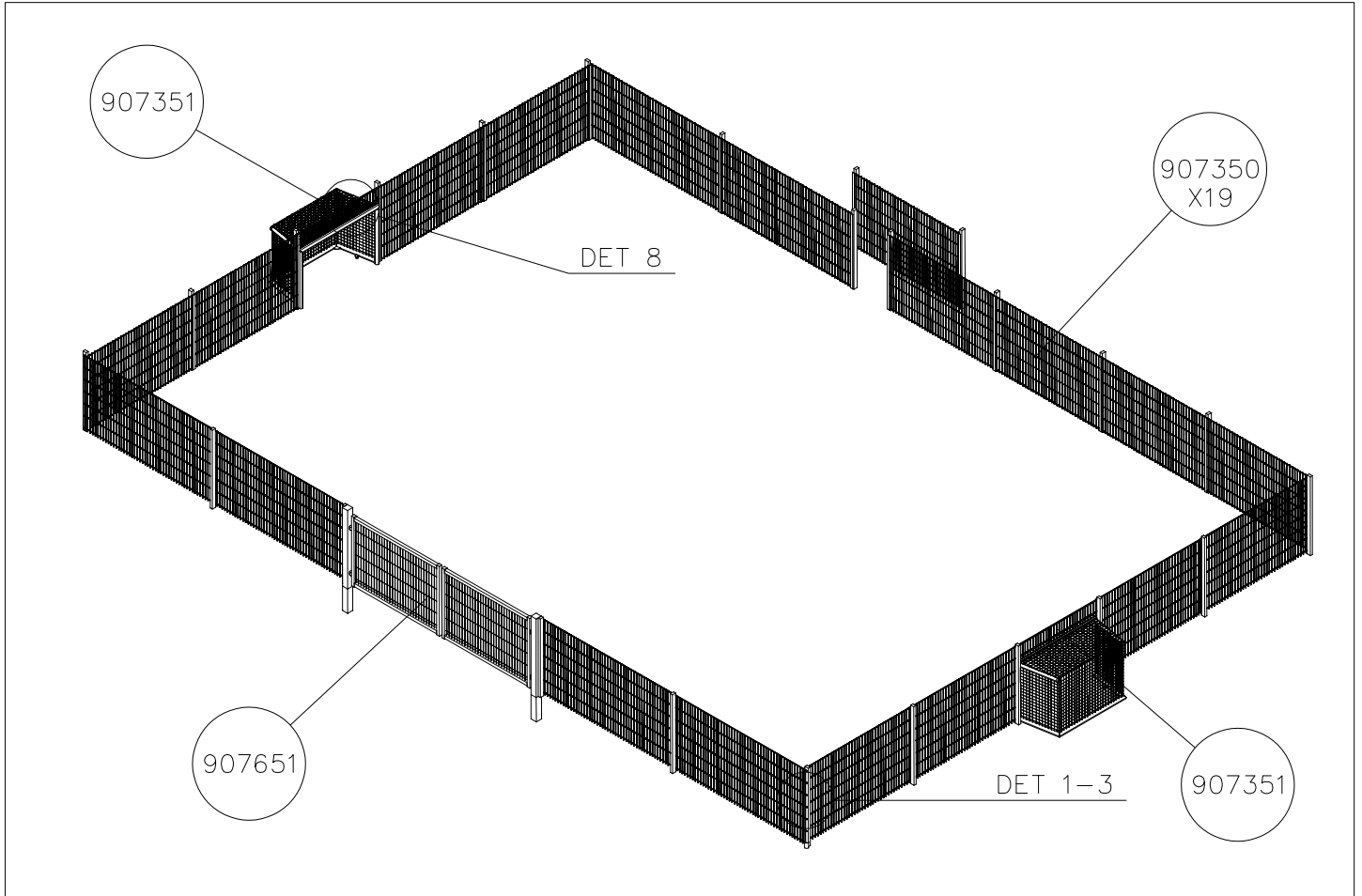

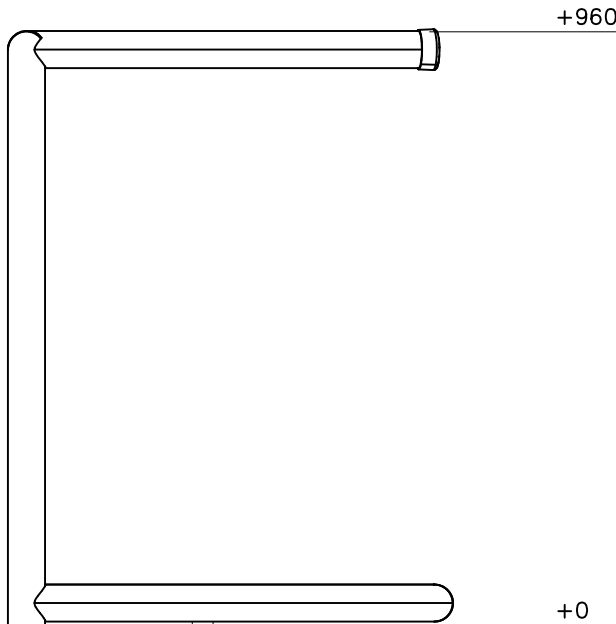
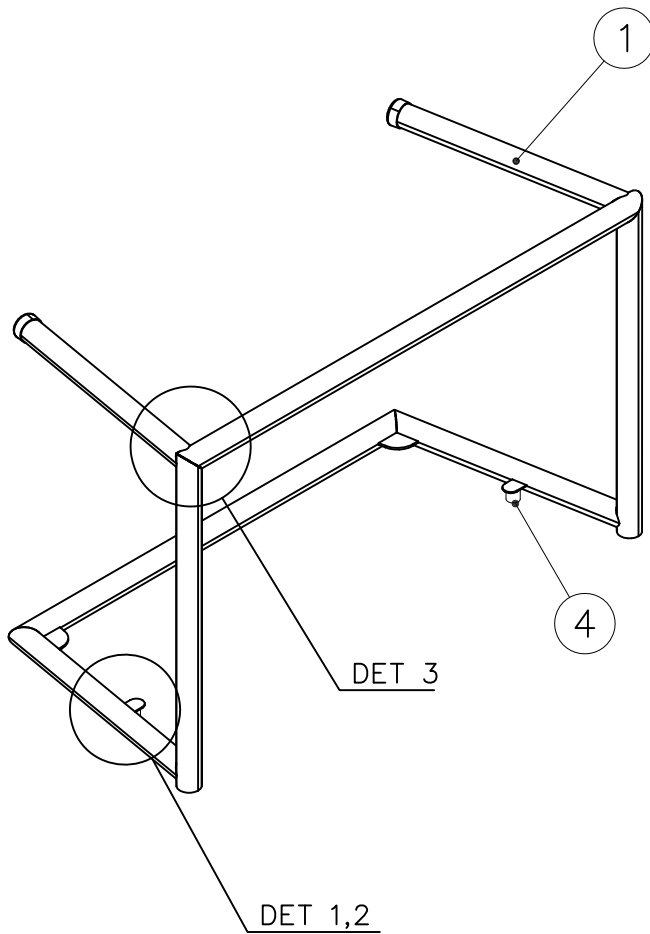
<p>DET 1</p> 	<p>DET 2</p> 	<p>DET 3</p> 	<p>DET 4</p> 
<p>DET 5</p> 	<p>DET 6</p> 	<p>DET 7</p> 	<p>DET 8</p> <p>After cutting paint with zinc spray.</p> 

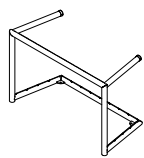

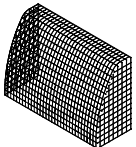
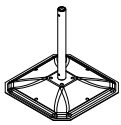
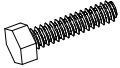

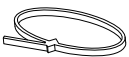
①	906776	PCS	②	702341	PCS
		1		1	
	1520x950x720		90x50		
③	906990	PCS	④	705797	PCS
		1		2	
	XS		L400		
⑤	909214	PCS	⑥	980154	PCS
		2		2	
	M12x50		Ø24/13		
⑦	907254	PCS	⑧	904728	PCS
		1		10	
		PCS			PCS
		PCS			PCS
		PCS			PCS
		PCS			PCS

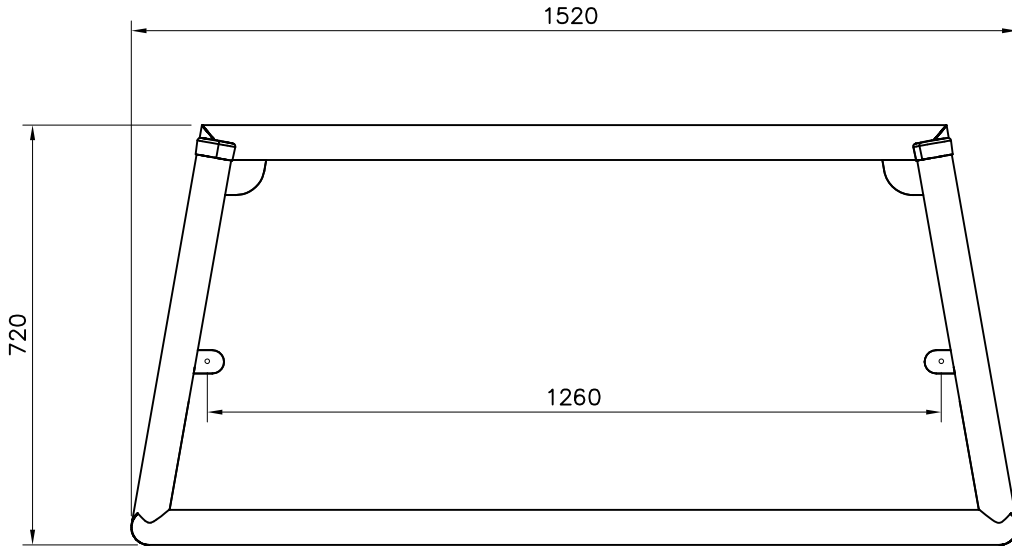

DET 1

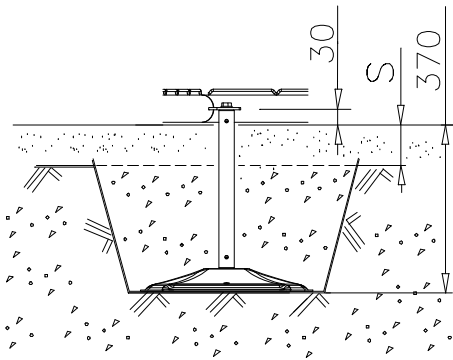

DET 2

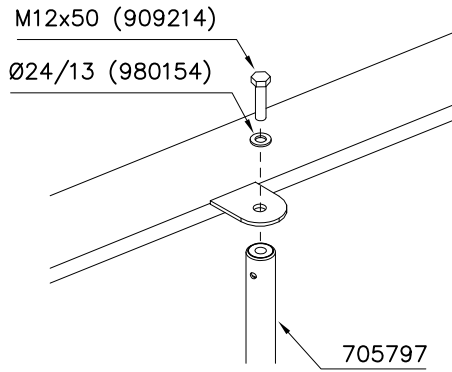

DET 3

Goal net needs to be fixed with an additional rope. Use cable ties to ease the fastening.

Maaliverkko kiinnitetään ylimääräisellä narulla. Käytä nippusiteitä kiinnittämisen apuna.

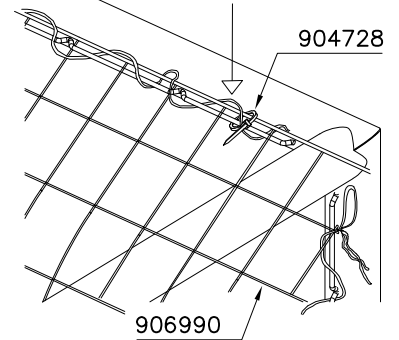



Tuotekyltti tulee tuotteen mukana yhdellä seuraavista tavoista:

1) Metallinen tuotekyltti ja kiinnitysruuvit

- Kiinnitä tuotekyltti ruuveilla tolppaan noin 2 metrin korkeuteen kuvan 1 mukaisesti.

2) Tuotekylttitarra

- Puhdista maalattu metalli- tai vaneripinta pölystä ja kosteudesta. Liimaa tarra kuvan 2 mukaisesti.
- Huom. Älä kiinnitä tarraa karheapintaiseen laminaattiin tai maalattuun puuhun.

Vår produktmärkning levereras på ett av följande sätt:

1) Produktskylt i metall

- Fäst skylten med de medföljande skruvarna

2) Självhäftande produktetikett

- Rengör den pulverlackerade metallytan eller laminatyten så att den blir fri från smuts och fukt. Fäst etiketten enligt fig. 2.
- Obs! Fäst ej etiketten på detaljer med skrovlig yta eller på målat trä.

Product label is delivered by one of following ways:

1) Metal product label and screws

- Fasten the label with screws.

2) Label sticker

- Clean the painted metal or plywood surface from dirt and moisture. Fasten the sticker as shown in the figure 2.
- Note. Do not attach the sticker to rough surfaced laminate or painted wood.

La plaque d'informations produit est livrée sous l'une de ces 3 formes :

1) Plaque métallique et vis

- Fixez la plaque à l'aide des vis.

2) Etiquette autocollante

- Avant de coller l'étiquette, nettoyez le composant métallique peint ou la plaque de contreplaqué, de toute saleté. La surface doit être sèche (voir image 2).
- Attention, ne pas coller l'étiquette sur une surface lamellé-collée irrégulière ou sur du bois peint.

Die Auslieferung des Produktaufklebers erfolgt auf eine dieser Arten:

1) Produkt-Schild aus Metall incl. Schrauben

- Die Befestigung des Schildes erfolgt mittels der Schrauben.

2) Aufkleber

- Entfernen Sie zunächst Schmutz und Feuchtigkeit vom lackierten Metall bzw. von der Holzoberfläche und bringen Sie den Aufkleber wie im Bild oben rechts beschrieben auf den gesäuberten Untergrund auf.
- Beachten Sie: Bringen Sie den Aufkleber nicht auf raues laminiertes oder lackiertes Holz an.