

EN Impact Area 0.1 m²

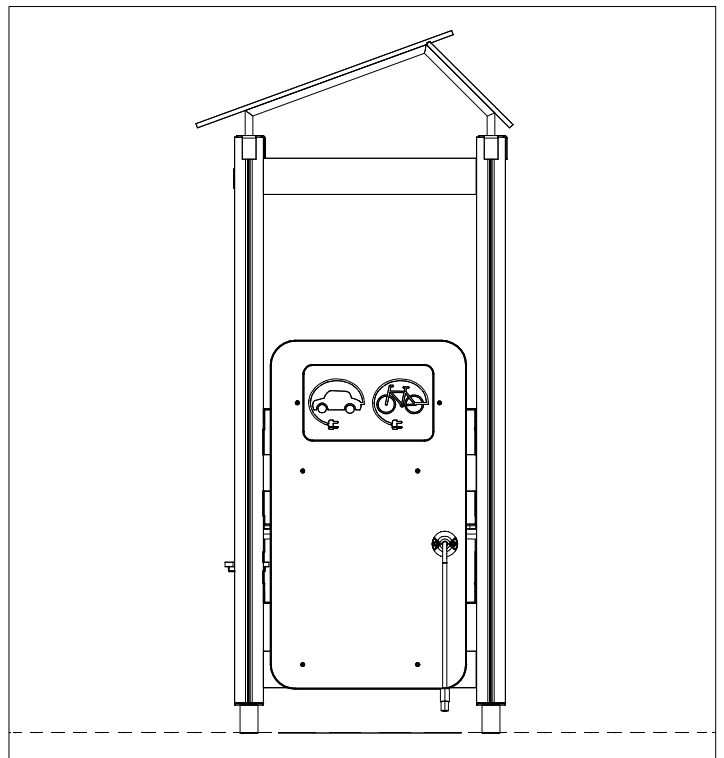

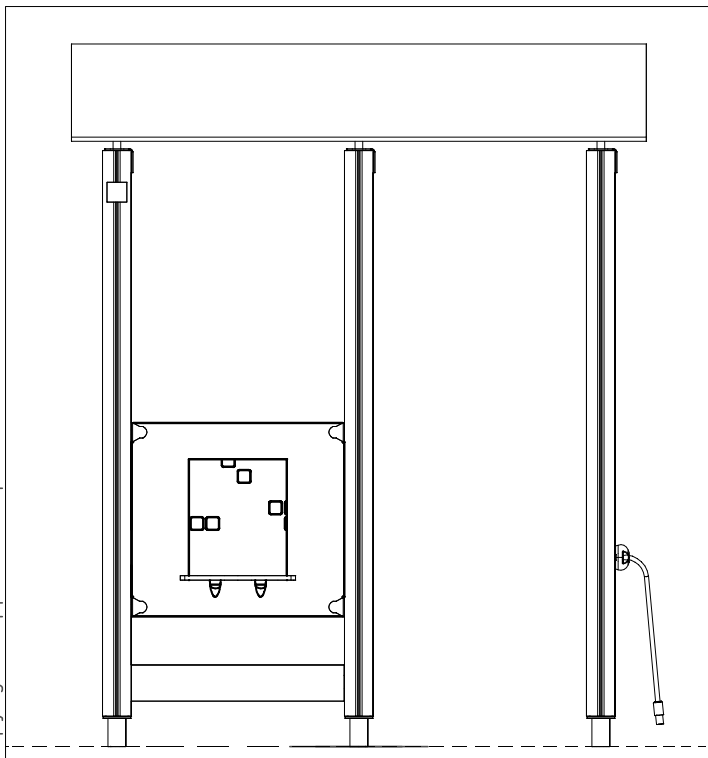

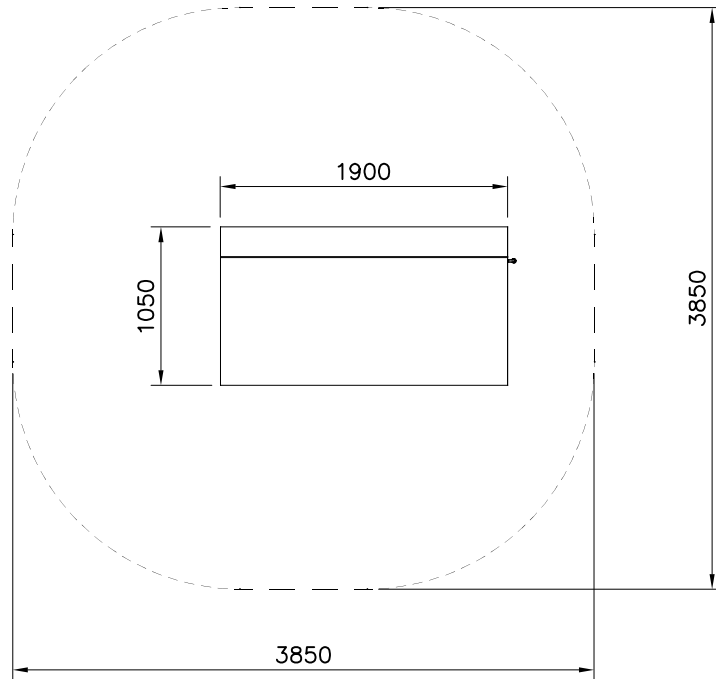
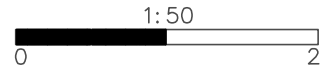
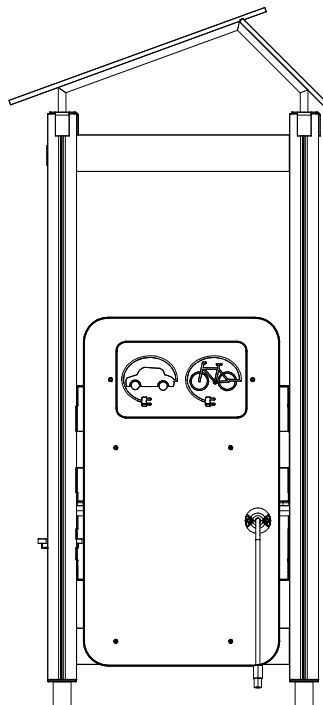
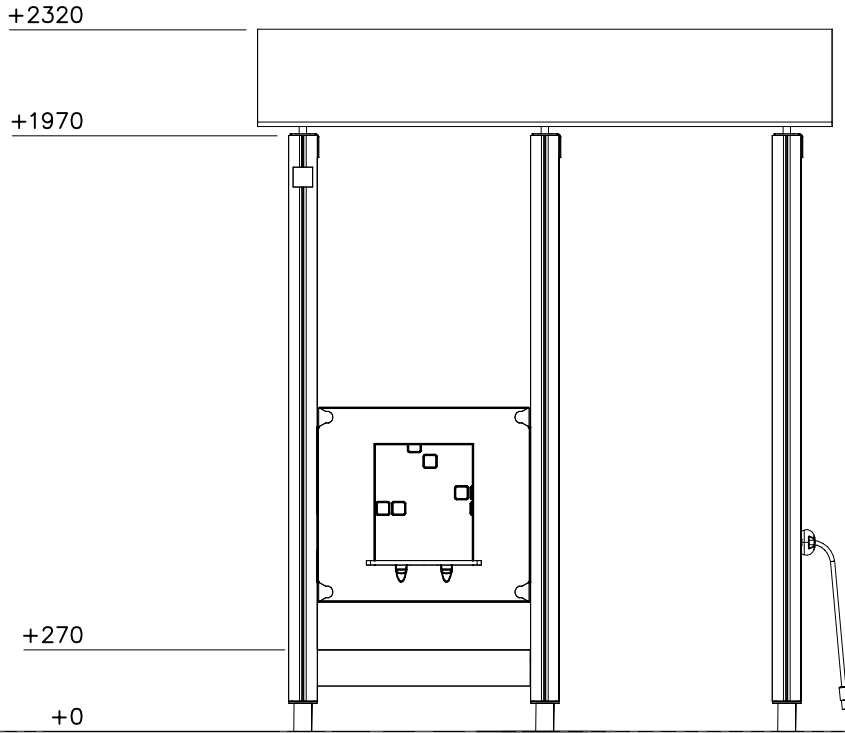

Falling Space 16.4 m²

Max Falling Height 270 mm

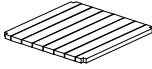
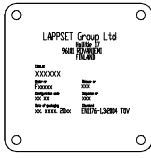
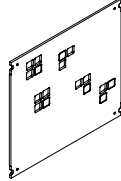
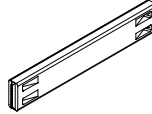
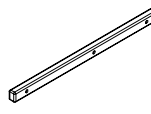
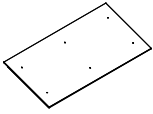
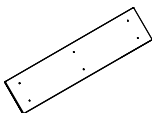

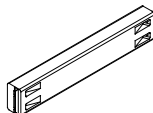
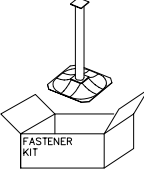
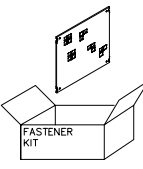
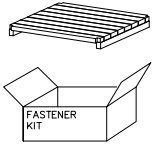
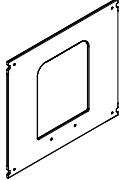
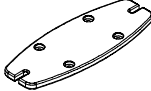
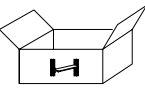
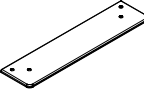
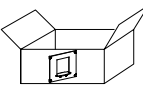
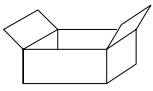
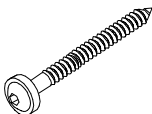
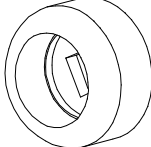
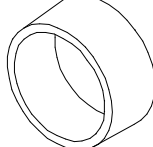
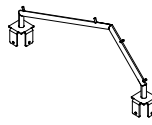
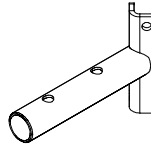
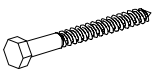

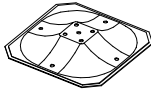
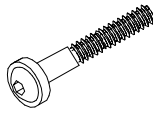
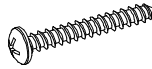
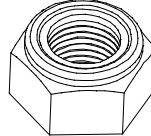
DATE: 21.11.2024

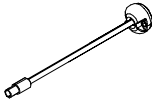
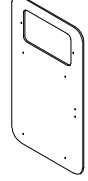
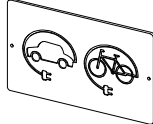
008986	PCS	702286	PCS	706436-707	PCS	706439	PCS	706443	PCS	706495	PCS
	1		1		2		6		2		1
750x750		65x65		10x640x702		L 704		32x45x702		15x900x1900	
706496	PCS	706511	PCS	706512	PCS	706531	PCS	706534	PCS	706535	PCS
	1		6		1		6		2		1
15x390x1900		93x93x1870		70x120x704		FASTENER KIT		FASTENER KIT		FASTENER KIT	
706727-707	PCS	706744	PCS	706753	PCS	706783	PCS	706885	PCS	706960	PCS
	1		1		1		1		1		1
10x702x640		15x145x380				15x170x700					
903093	PCS	905083	PCS	905112	PCS	907667-216	PCS	907783-216	PCS	909236	PCS
	28		6		6		3		2		4
Ø8x90										8x55	
909511	PCS	909519	PCS	909876	PCS	980114	PCS	980150	PCS	980151	PCS
	6		6		4		4		8		6
90x90x650		50x380x380		8x40		Ø4x20		M8			
P00978	PCS	P10001-707	PCS	P12921	PCS		PCS		PCS		PCS
	1		1		1						
	PCS		PCS		PCS		PCS		PCS		PCS