

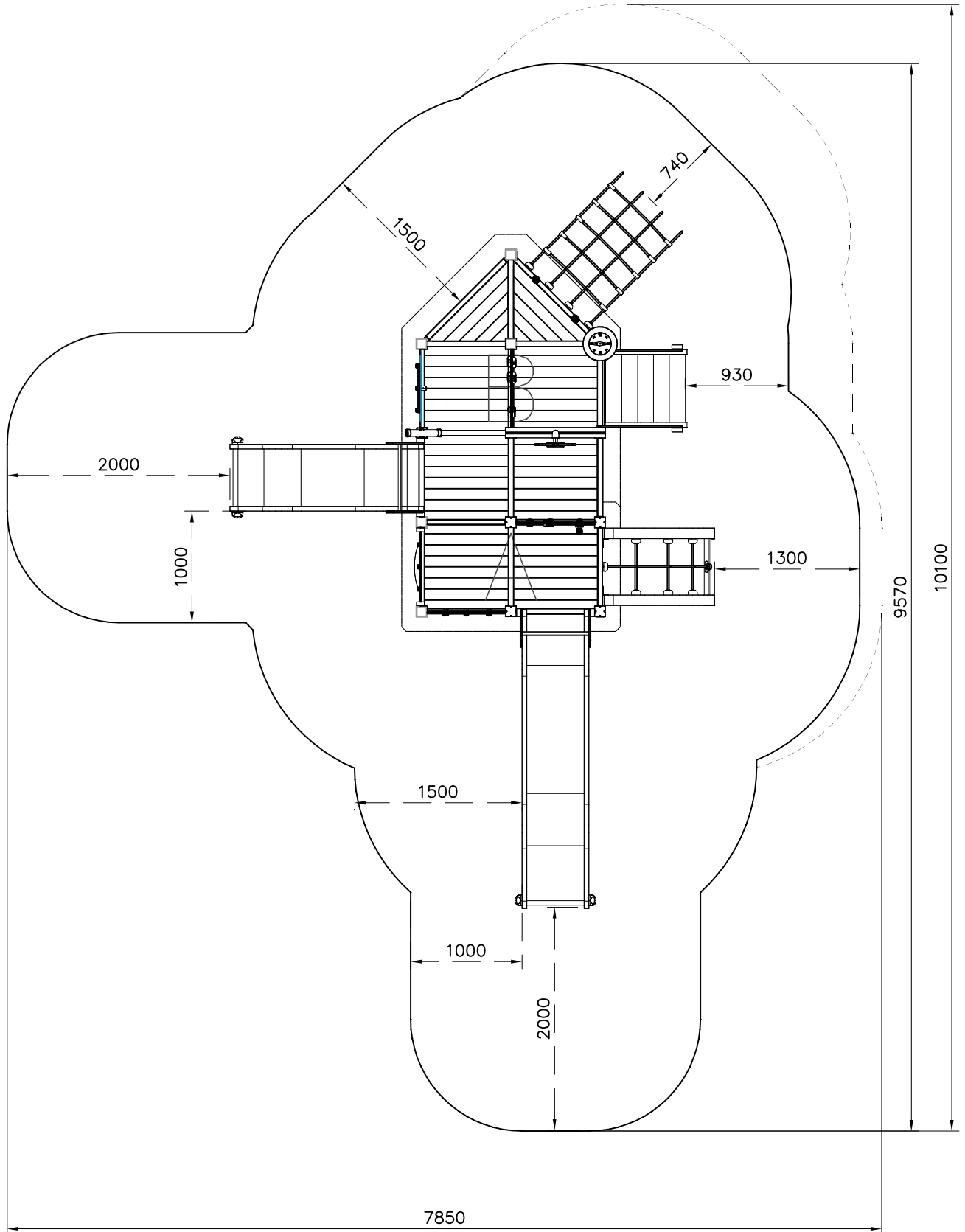

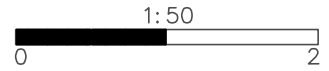

— — EN/AS Impact Area 42.6 m²

--- Falling Space 46.5 m²
Max Falling Height 1470 mm

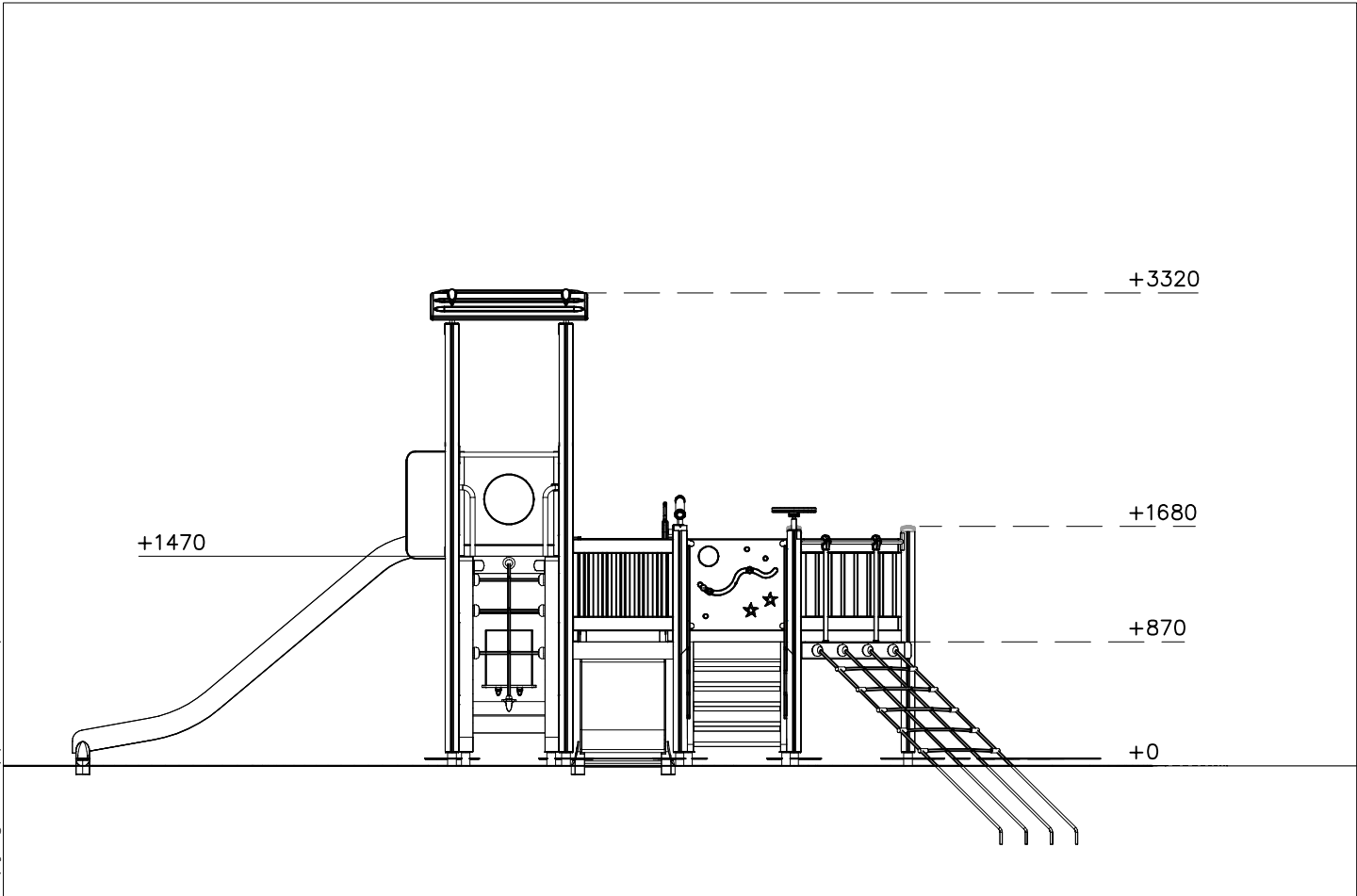
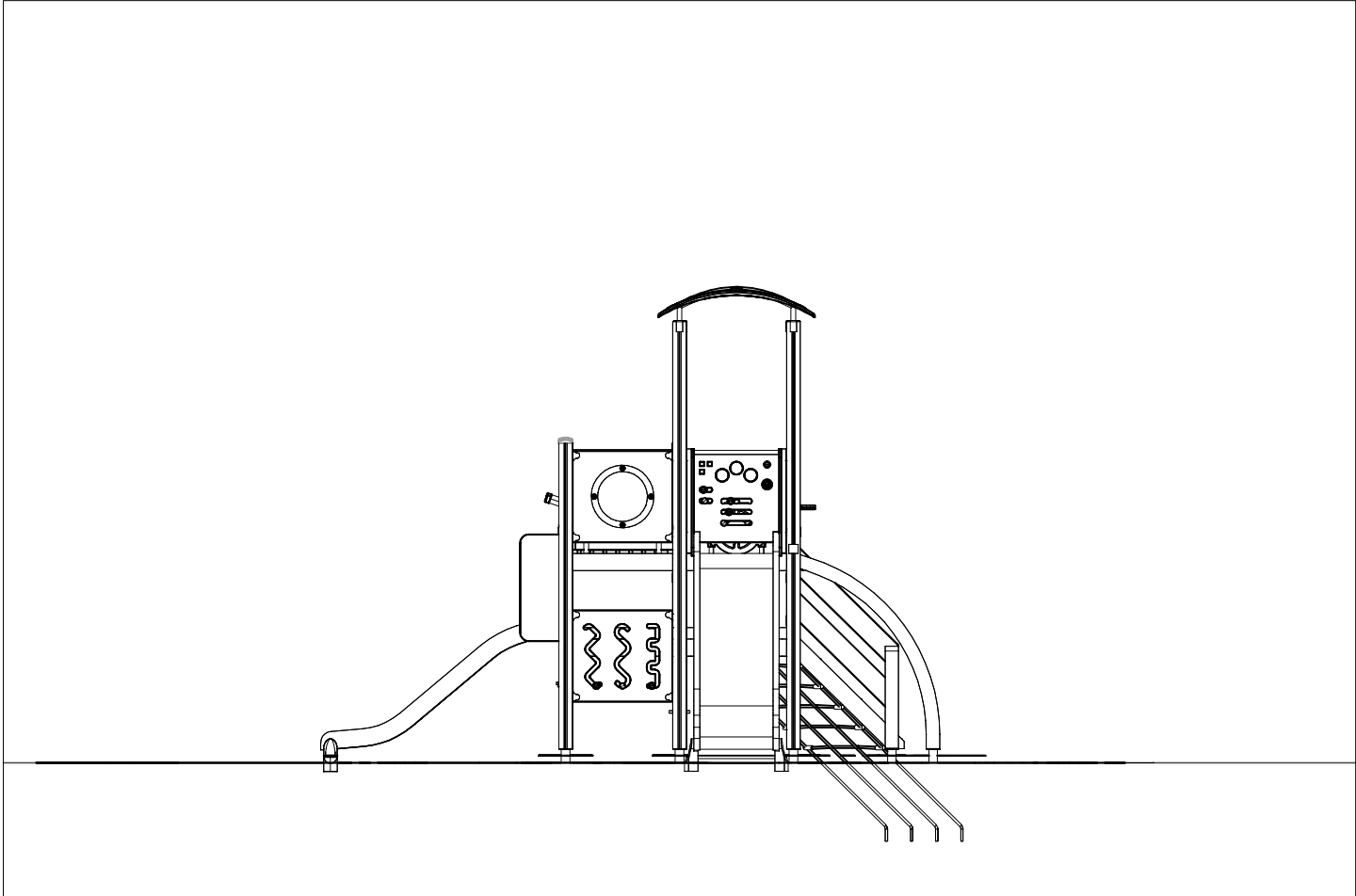

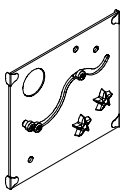
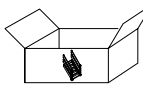
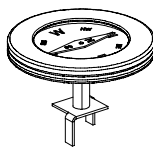
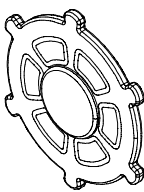
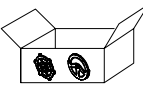
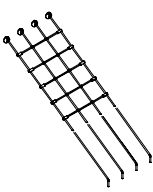
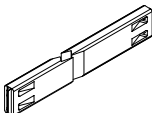
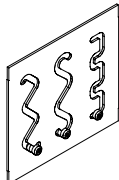
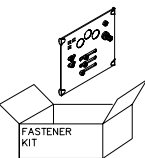
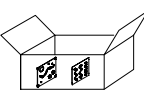
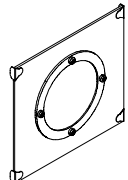
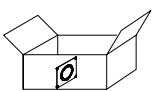
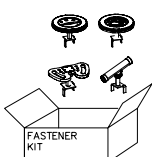
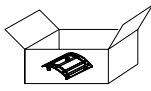
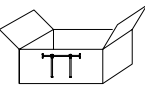
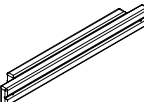
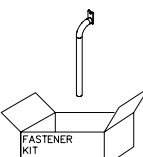
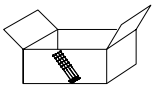
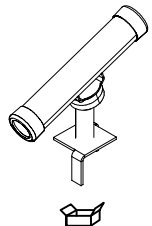
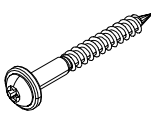
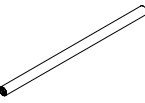
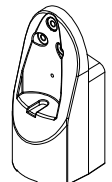
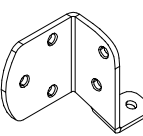
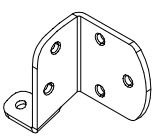
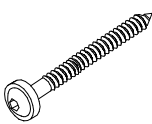
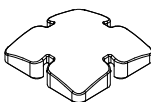
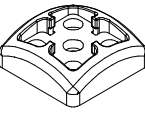
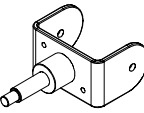
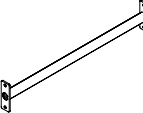
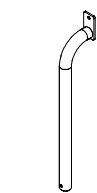
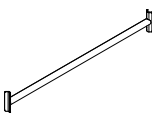
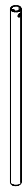
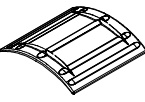
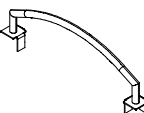

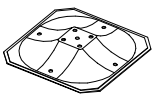
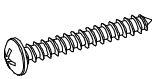
DATE: 21.11.2024

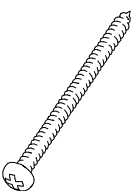
707209-701	PCS 1	707224	PCS 1	707303-701	PCS 1	707320-702	PCS 1	707333	PCS 1	707351-305	PCS 1
											
10x640x702											
707374	PCS 2	707386-701	PCS 1	707449	PCS 1	707450	PCS 2	707453-701	PCS 2	707454	PCS 2
											
L 1504		10x640x702		FASTENER KIT				10x640x702			
707585	PCS 1	707623	PCS 1	707625	PCS 1	707626	PCS 1	707732	PCS 4	707864	PCS 1
											
FASTENER KIT						L 890		FASTENER KIT			
711535	PCS 1	900240	PCS 8	901868	PCS 6	901879	PCS 4	902439	PCS 1	902474	PCS 1
											
		Ø8x70		Ø34x598				Left Hand		Right Hand	
903093	PCS 78	905138	PCS 5	905196	PCS 5	905879	PCS 1	907694-216	PCS 2	907701-216	PCS 4
											
8x90		GRAY		GRAY				L 704			
907920-216	PCS 1	908044-216	PCS 2	908251	PCS 1	908330-216	PCS 2	909511	PCS 15	909519	PCS 17
											
120x40x1029		Ø33,7x679		1100x1100x215				90x90x650		50x380x380	
980114	PCS 4	980123	PCS 4	980128	PCS 8	980131	PCS 20				
											
Ø4x20		Ø7x60		Ø7x40		Ø6x60					