

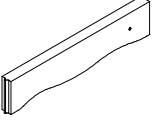

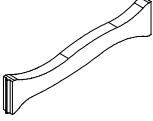

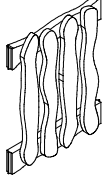

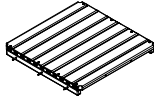

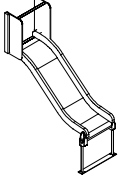

DATE: 22.10.2024

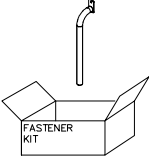
702286	PCS	705211-001	PCS	705214-001	PCS	705230-001	PCS	705258-001	PCS	706234-001	PCS
	1		2		1		2		1		1
65x65		45x145x715		45x145x724							
707732	PCS	711369-001	PCS	903093	PCS	905104	PCS	907688-216	PCS	909521	PCS
	2		4		10		16		2		4
		93x93x1846		Ø8x90		M10					
980114	PCS		PCS		PCS		PCS		PCS		PCS
	4										
Ø4x20											
	PCS		PCS		PCS		PCS		PCS		PCS
	PCS		PCS		PCS		PCS		PCS		PCS
	PCS		PCS		PCS		PCS		PCS		PCS

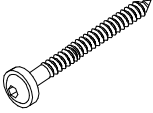
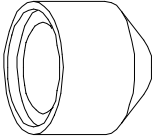
- EN/AS Impact Area 18.5 m²
- - - Falling Space 18.5 m²
Max Falling Height 1000 mm

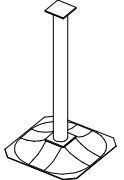

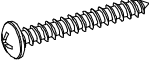
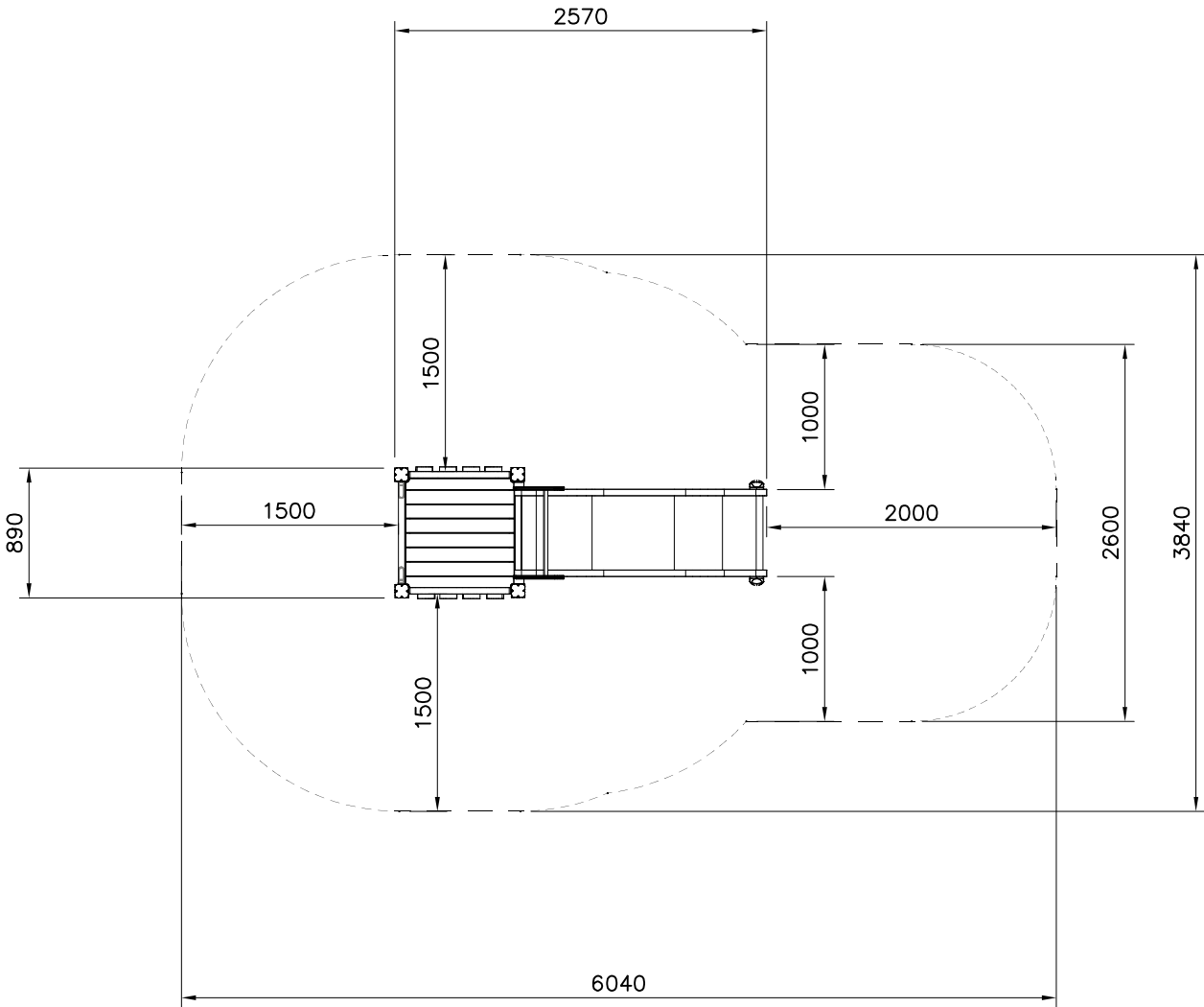
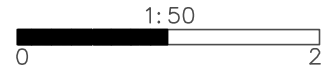
1:40

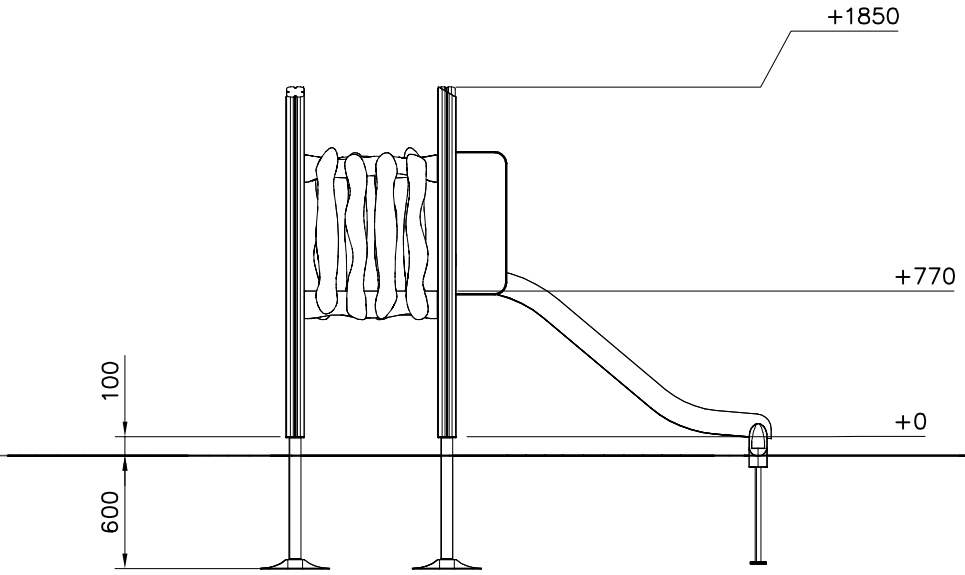

1:40

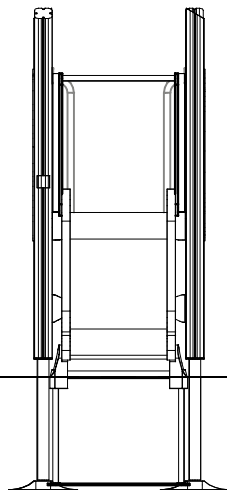

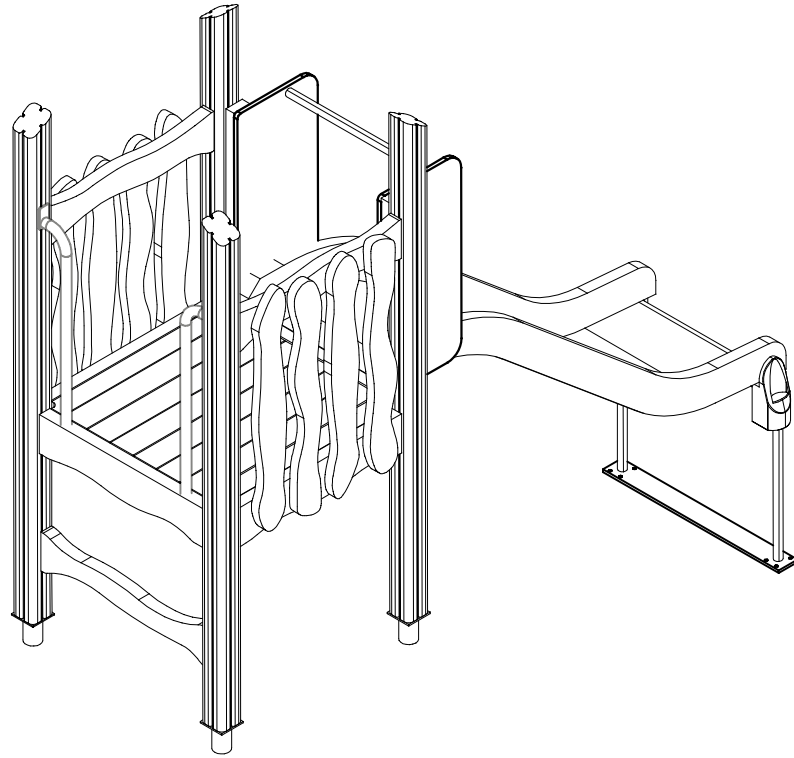

Max falling height

