

- EN/AS Impact Area 7,4 m<sup>2</sup>
- Falling Space 20.2 m<sup>2</sup>  
Max Falling Height 1000 mm

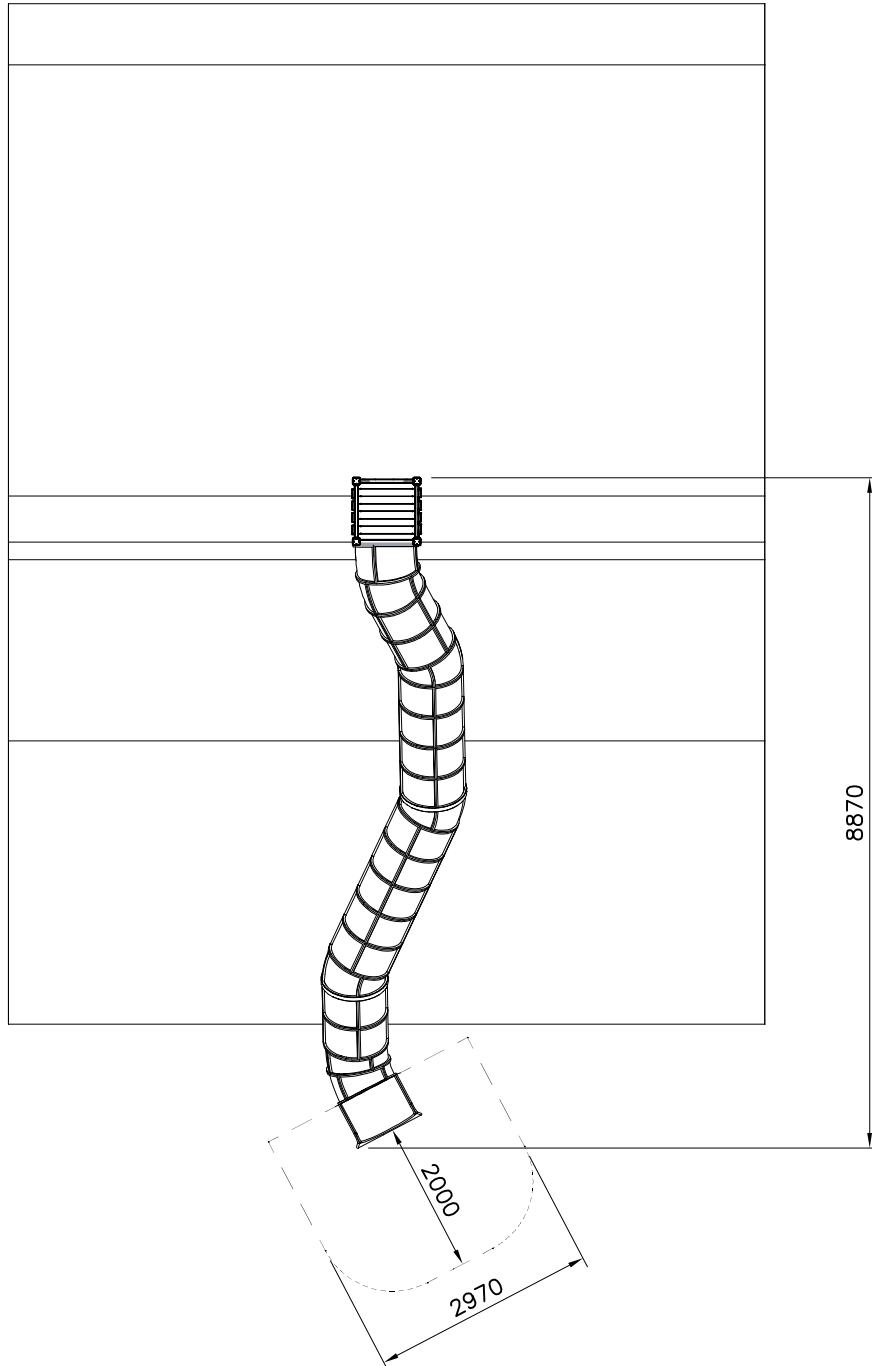

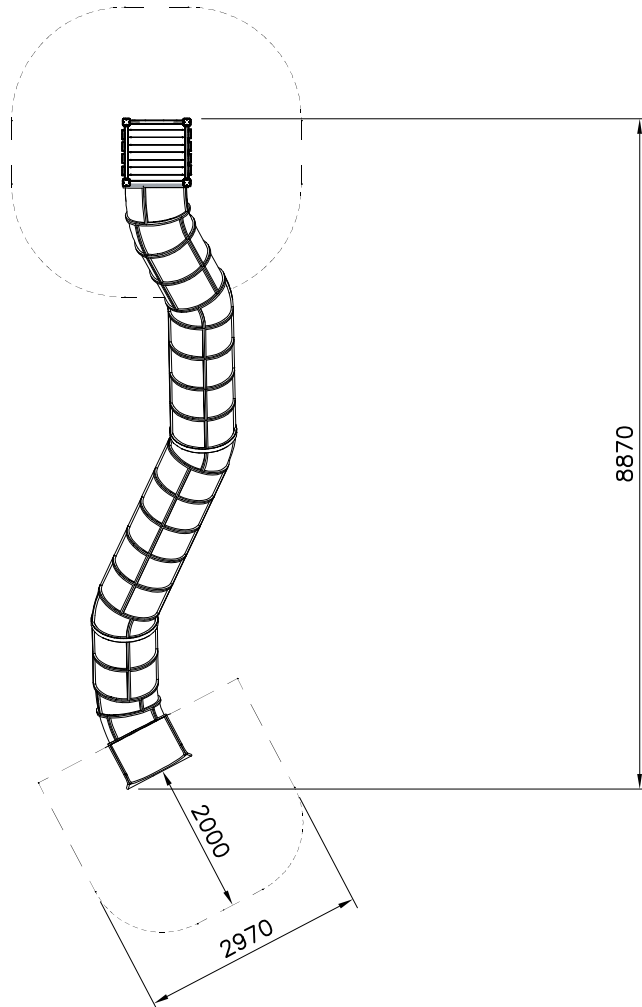

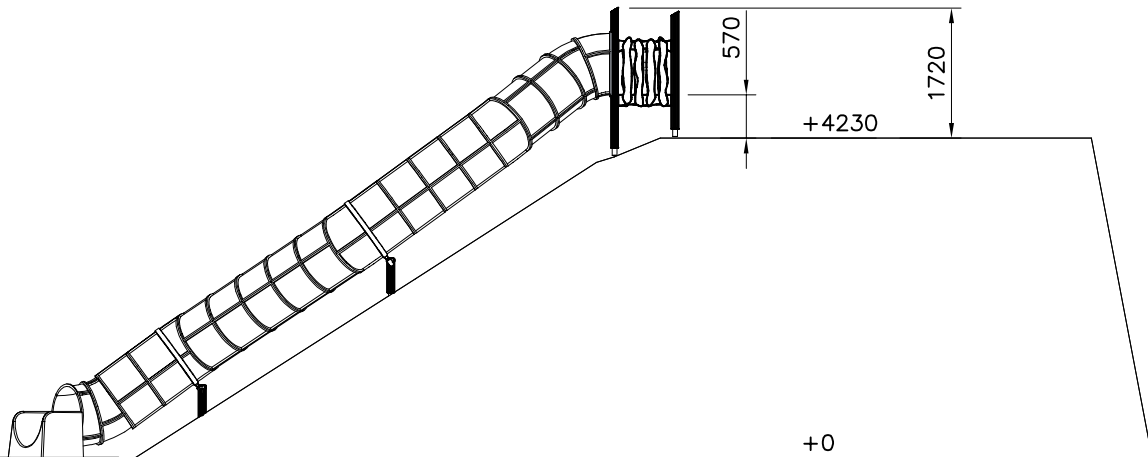

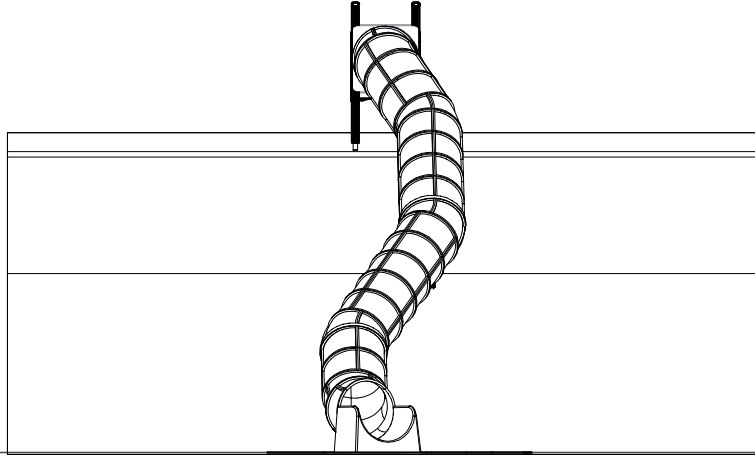

- EN/AS Impact Area 7,4 m<sup>2</sup>
- Falling Space 20.2 m<sup>2</sup>  
Max Falling Height 1000 mm

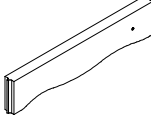
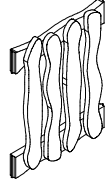
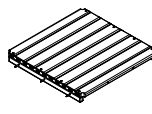

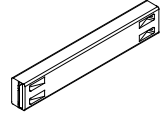
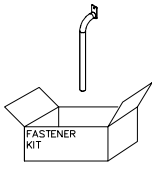

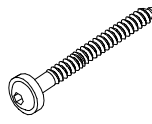
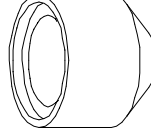
DATE: 10.10.2024

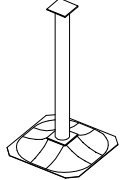
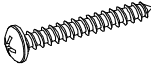
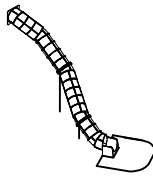
702286	PCS	705211-614	PCS	705230-614	PCS	705258-614	PCS	705381-614	PCS	706512-614	PCS
	1		1		2		1		2		1
65x65		45x145x715						93x93x450		70x120x724	
707732	PCS	711369-614	PCS	711370-614	PCS	903093	PCS	905104	PCS	907688-216	PCS
	2		2		2		8		24		2
		93x93x1846		93x93x1546		Ø8x90		M10			
909521	PCS	980114	PCS	A10572	PCS		PCS		PCS		PCS
	6		4		1						
		Ø4x20									
	PCS		PCS		PCS		PCS		PCS		PCS
	PCS		PCS		PCS		PCS		PCS		PCS
	PCS		PCS		PCS		PCS		PCS		PCS