

LAPPSET®

FINNO





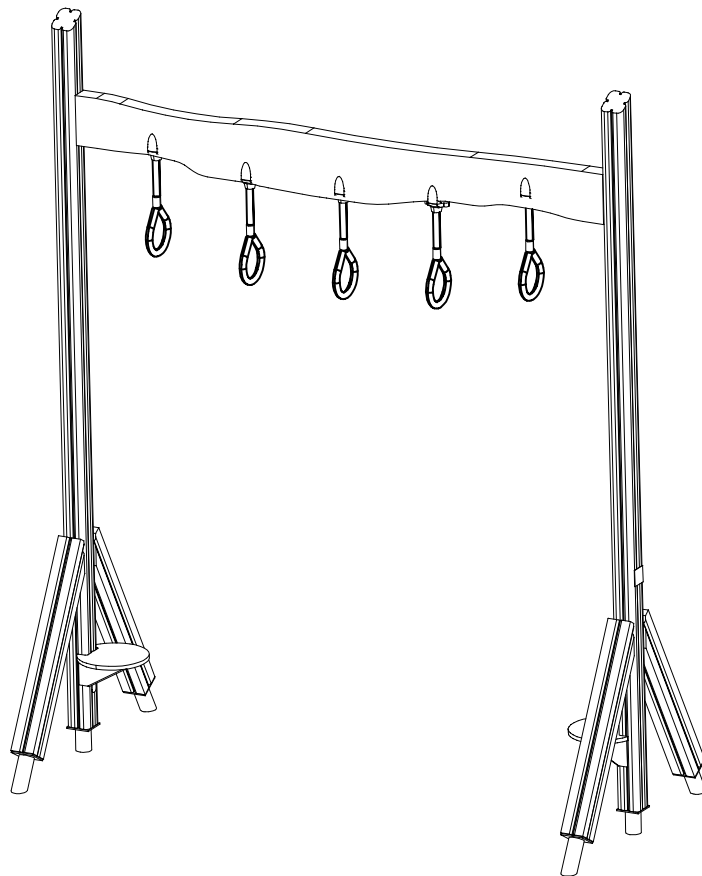

A SENNUSOHJE
MONTERINGSANSVISNING
INSTALLATION INSTRUCTION
AUFBAUANLEITUNG
NOTICE D'INSTALLATION

DATE: 1.10.2024

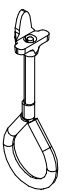
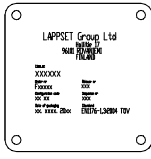
QFL0159

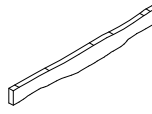
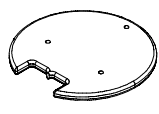
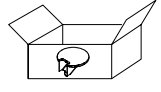
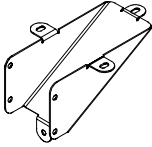
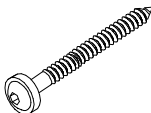
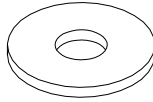
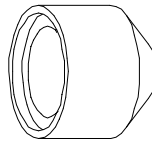

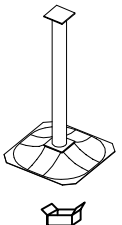
DATE: 1.10.2024

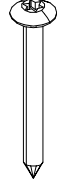
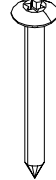
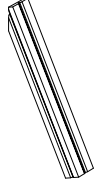
701683  L 400	PCS 5	702286  65x65	PCS 1	705238-001  93x93x2846	PCS 2	705431-001  68x260x2280	PCS 1	707696-704  15x265x275	PCS 2	707729  2	PCS 2
902086  148x172x254	PCS 2	903093  Ø8x90	PCS 6	905051  Ø24/8.5	PCS 8	905104  M10	PCS 24	909231  8x130	PCS 4	909233  8x100	PCS 4
909521  L 840	PCS 6	980114  Ø4x20	PCS 4	980123  Ø7x60	PCS 10	980128  Ø7x40	PCS 5	P00109  L 840	PCS 4		PCS
	PCS		PCS		PCS		PCS		PCS		PCS
	PCS		PCS		PCS		PCS		PCS		PCS
	PCS		PCS		PCS		PCS		PCS		PCS
	PCS		PCS		PCS		PCS		PCS		PCS

EN/AS Impact Area 12.7 m²

Falling Space 15.2 m²

Max Falling Height 1000 mm

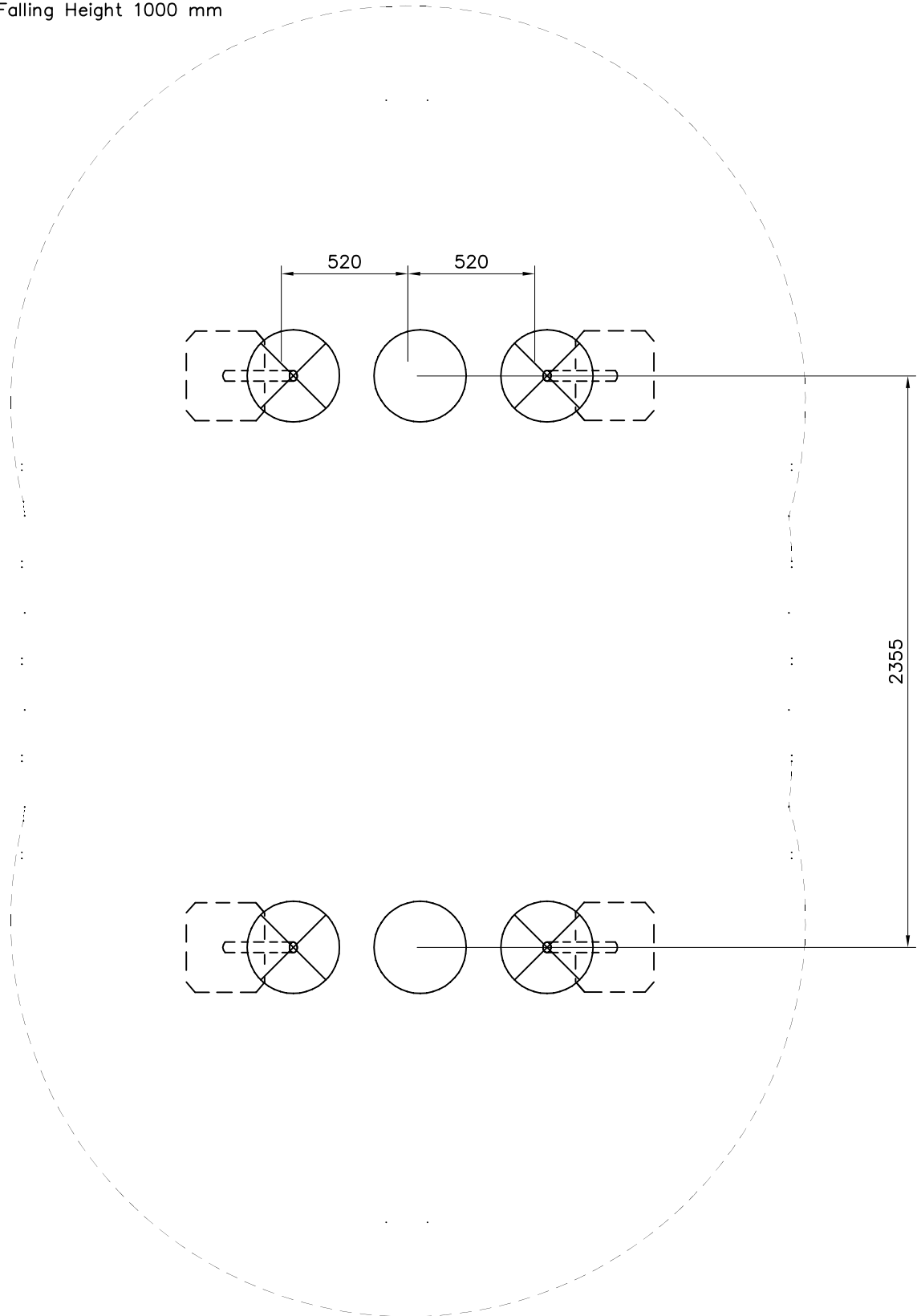

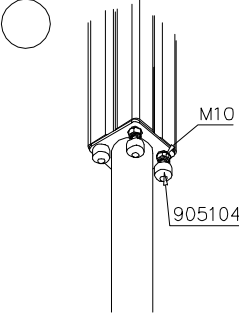
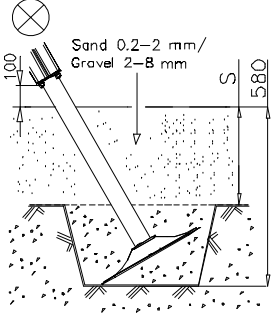
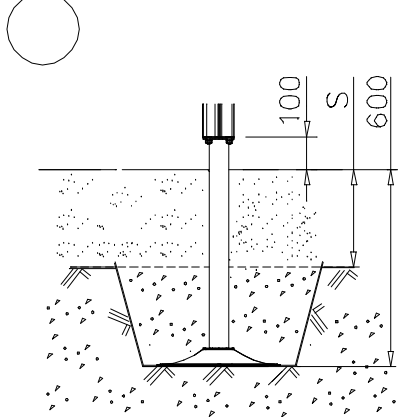

—— EN/AS Impact Area 12.7 m²
 - - - - Falling Space 15.2 m²
 Max Falling Height 1090 mm

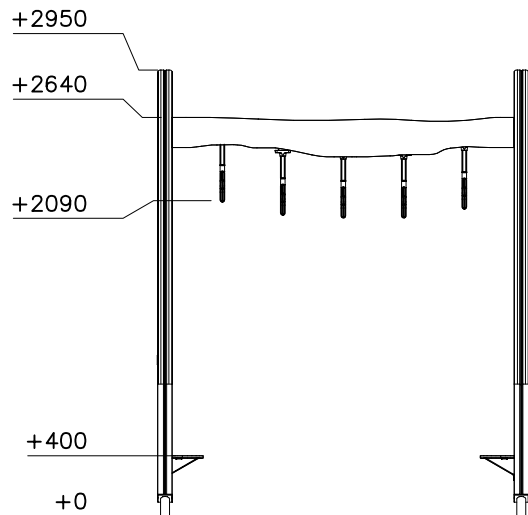
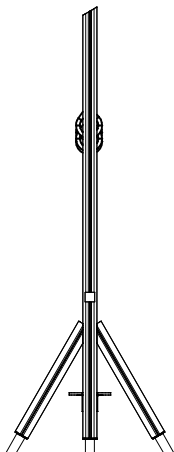
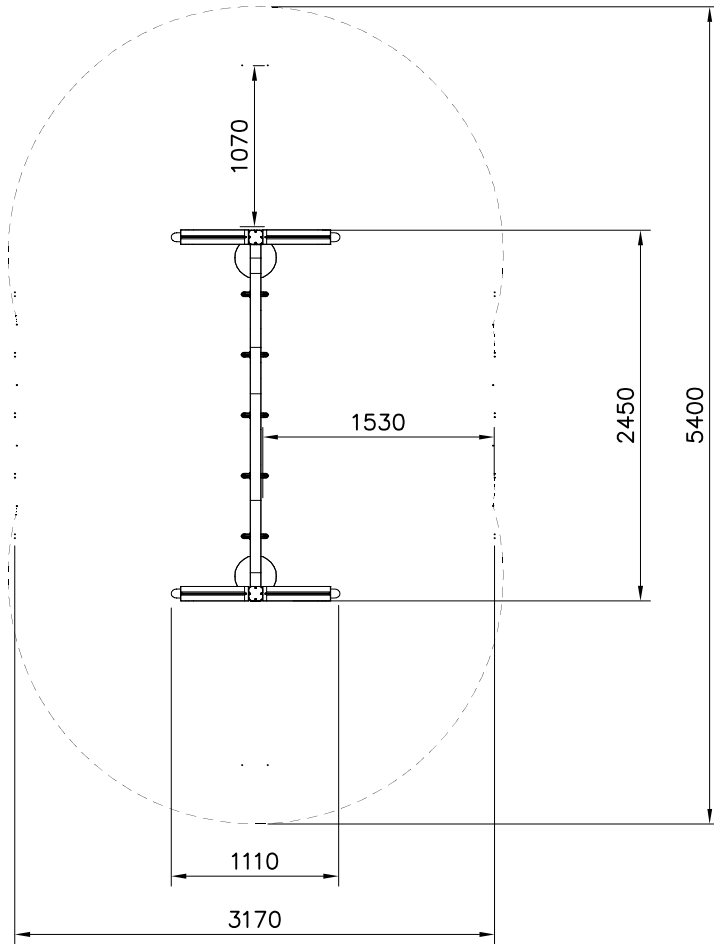
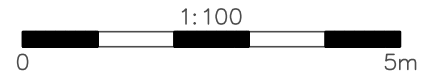

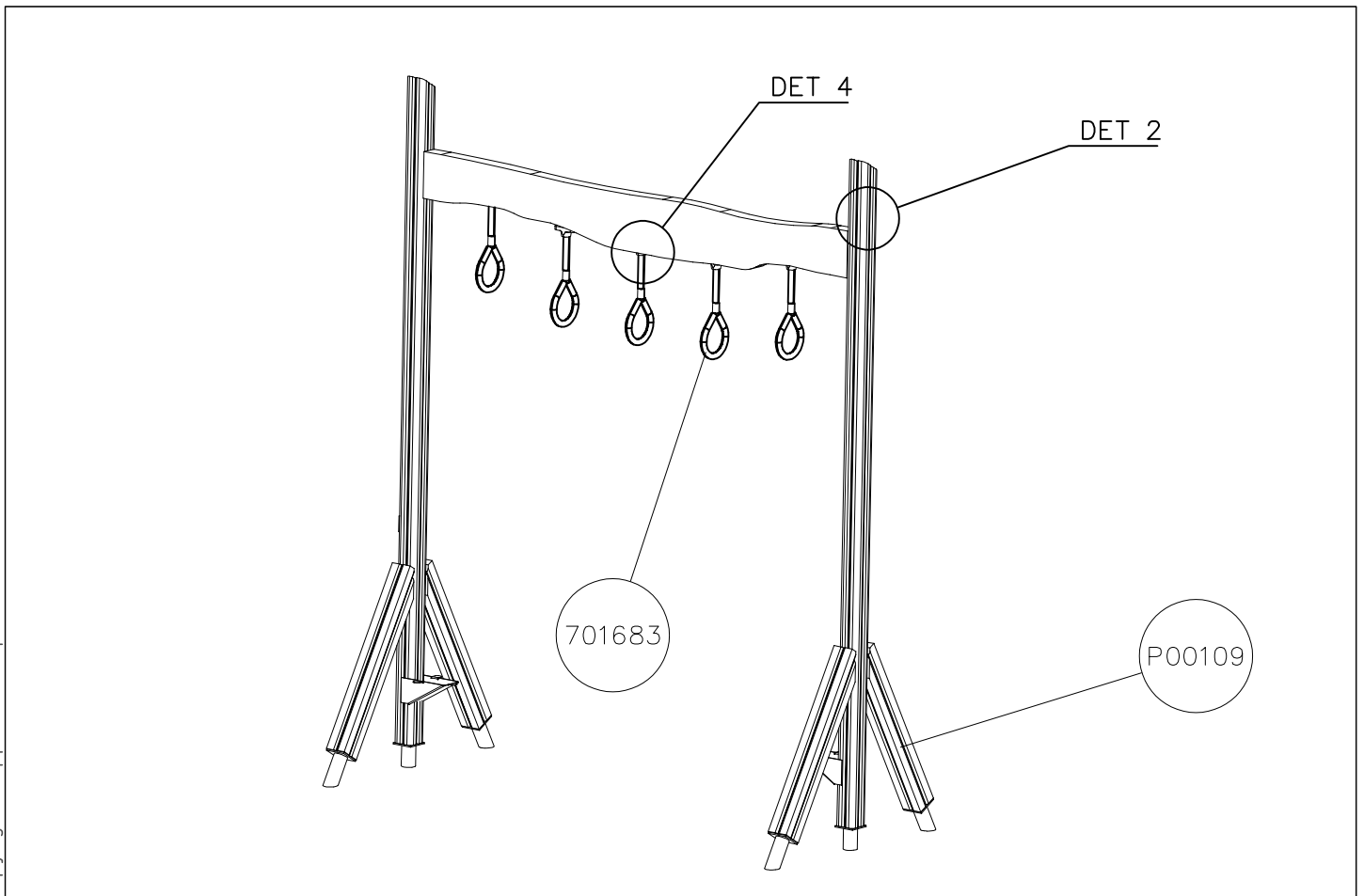
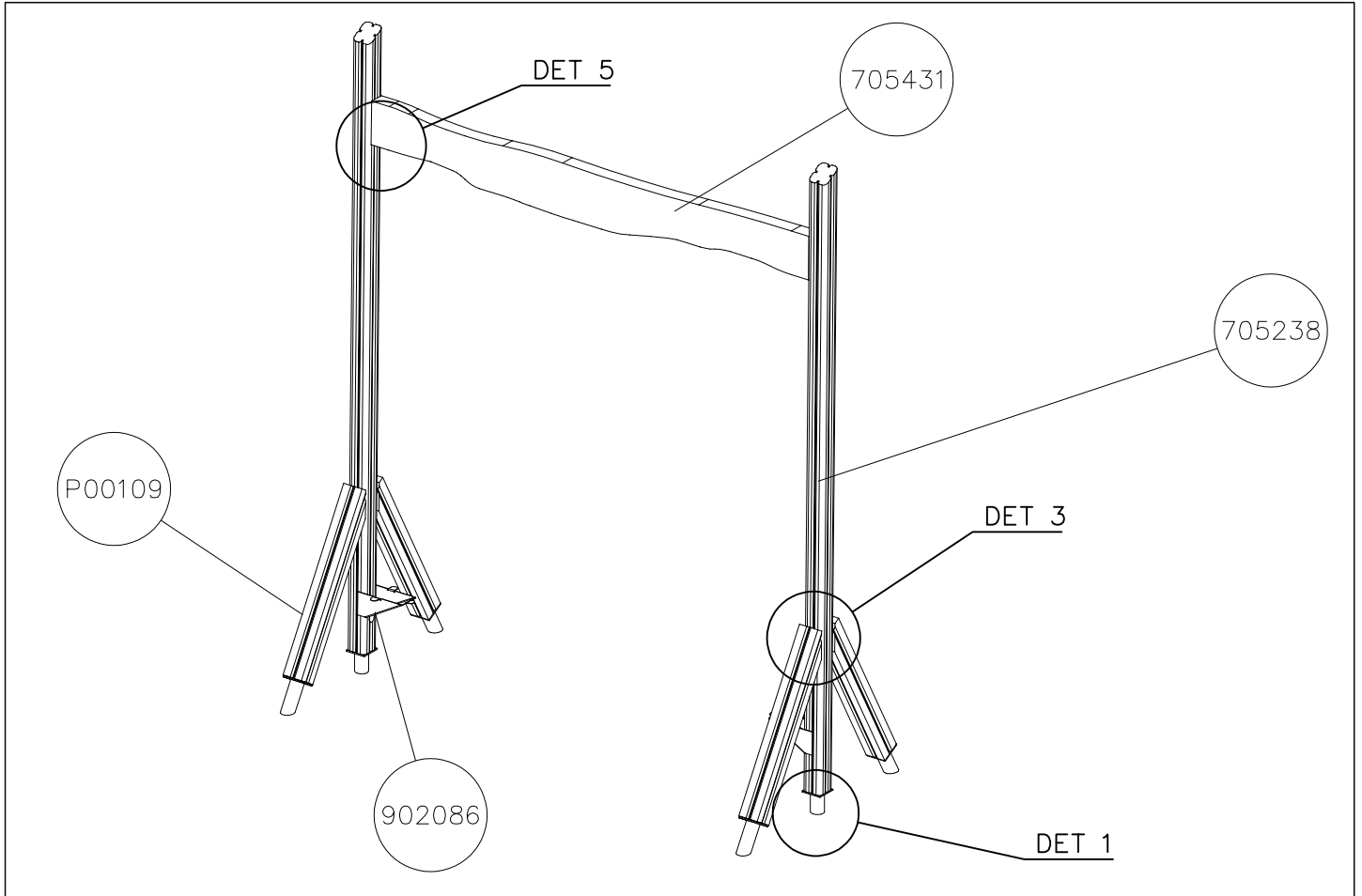

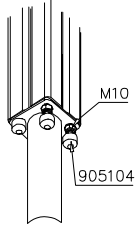
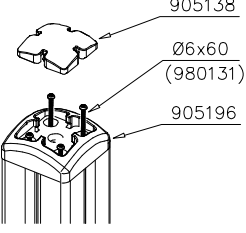
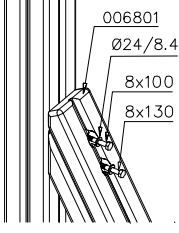
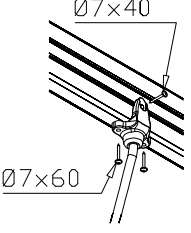
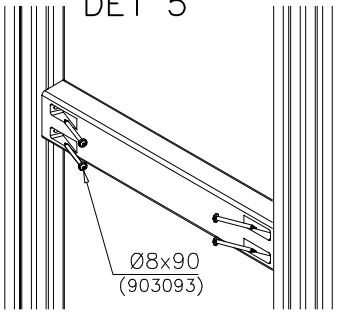
<p>DET 1</p> 	<p>DET 2</p> 	<p>DET 3</p> 	<p>DET 4</p> 
<p>DET 5</p> 			

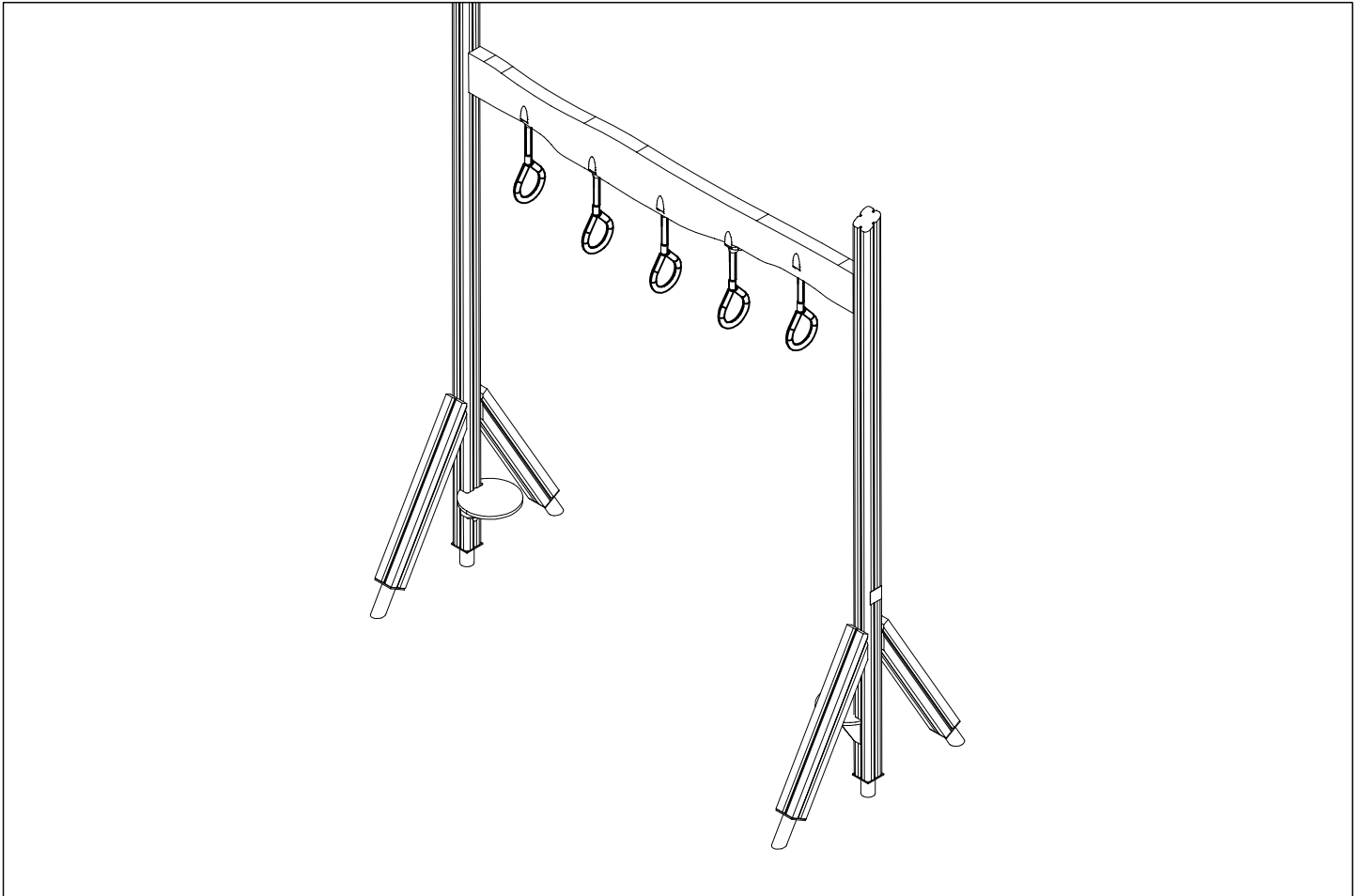

		
<p>$h < 600$</p> <p>Without movement and therefore without Impact Area</p>	<p>Totally hard surfaces.</p> <p>Note. Lappset does <u>not recommend</u> totally hard surfaces at all.</p>	<p>E.g. concrete or asphalt</p> 
<p>$h < 600$</p> <p>With movement e.g. rocking</p>	<p>Materials with very limited impact attenuating properties.</p>	<p>E.g. wood</p> 
<p>$h < 1000$</p>	<p>Materials with significant impact attenuating properties.</p>	<p>fine gravel 0–8 mm</p>  <p>grass</p>  <p>unsorted sand</p> 
<p>$h < 3000$</p>	<p>Loose fill material</p> <p>E.g. sand/gravel 0,25...8 mm D60/D10<3,0 Woodchips 5...30 mm bark 20...80 mm</p>	 <p>\underline{S} \underline{h}</p> <p>30 cm < 2,0 m</p> <p>40 cm < 3,0 m</p>
	<p>Syntethic granulates</p> <p>\underline{S} \underline{h}</p> <p>40 mm ~> 1,2...1,3 m</p> <p>50 mm ~> 1,5...1,7 m</p> <p>60 mm ~> 1,8...2,0 m</p> <p>70 mm ~> 2,1...2,5 m</p> <p>Note. For accurate values, see manufacturer's instructions.</p>	

REMOVE SAFETY SURFACE/SAND/GRAVEL
TO CHECK FOUNDATION



REMOVE SAFETY SURFACE/SAND/GRAVEL
TO CHECK FOUNDATION

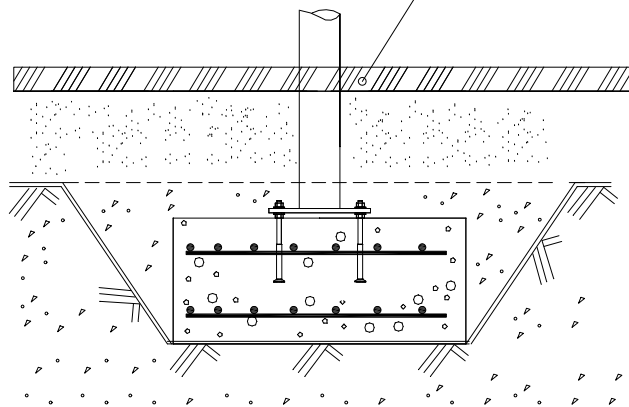

KIIPEILYTELINEET

1. Tarkista pakkauslistan avulla, että olet saanut tarvitsemasi osat (s. 3).
2. Valitse leikkivälineelle paikka ottaen huomioon valmistajan ilmoittamat **turvaetäisyydet** (s. 5).

*Tasoita alue. Tee tarvittavat peruskaivannot (s. 4). Valitessasi leikkivälineen asennussuuntaa huomioi mahdollinen altistuminen voimakkaalle auringonpaisteelle tai tuulelle.

* Sopiva alusta on hiekka, raekooltaan 0.2–2 mm tai sora, raekooltaan 2–8 mm. Kerroksen vähimmäispaksuus on 30 cm.

Voimakkaan tuulisille alueille suositellaan pyöreitä pikkukiviä. Mikäli käytät alustana turvalaattoja, noudata tarkasti valmistajan asennus- ja muita ohjeita.

*Asenna perustusjalat tolppiin.

3. Telineen pystytysohjeet esitetään sivuilla 6 ->. Valitse oikean mittaiset tolpat ja kiinnitä puomit ohjeiden mukaan. Asenna verkot, tangot, tikkaat ym. tämän ja osa-asennusohjeiden mukaan. Pakkauslistassa (s. 3)  - merkittyjen osien ohjeet ja kiinnitystarvikkeet löydät erillisistä pakkauksista.

Noudata valmistajan ilmoittamia mitoituksia.

Viimeisellä sivulla esitetään koko leikkivälineen kokoonpano.

4. Tarkista, että teline on suorassa ja perustukseltaan tukeva. Täytä kaivannot ja suorita tiivistys 300 mm täytön jälkeen.

5. **Tee käyttöönottotarkastus** ennen kiipeilytelineen käyttöönottoa pakkauksessa olevan pöytäkirjan mukaan. Pöytäkirja tulee dokumentoida. Muista, että pääsy leikkikentälle tulee estää, kunnes leikkipaikka on valmis ja turvallinen ja kaikki työkalut on viety pois.

KLÄTTERSTÄLLNINGAR

1. Kontrollera mot följersedeln att du erhållit samtliga komponenter (s. 3).
2. Välj lekredskapets plats. Beakta **säkerhetsavstånd** som tillverkaren angivit (s. 5).

*Avjämna ytan. Schakta där så krävs enligt monteringsanvisningen (s. 4). Beakta sol- och vindförhållandena vid val av lekredskapets placering.

* Lämpligt underlag är grov sand med kornstorleken 0,2 till 2 eller grovt grus med kornstorleken 2–8 mm i ett lager på min. 300 mm. På platser utsatta för hård vind rekommenderas rund småsten. Om falldämpande gummimattor används som underlag, bör tillverkarens monteringsanvisningar och andra anvisningar följas extra noggrant.

*Montera stålfötterna på stolparna.

3. Monteringsanvisningar för klätterställningen finns på sidorna 6 ->. Välj stolpar med rätt längd och fäst bommarna enligt anvisningarna. Montera nät, stänger, stegar osv. enligt monteringsanvisningarna. Anvisningar och fästdon till

komponenter som på följersedeln (s. 3)  finner du i separata förpackningar.

Följ de dimensioner som tillverkaren angivit. På sista sidan visas hur hela lekredskapet monteras ihop.

4. Kontrollera att redskapet står rakt och att förankringen är stadig. Återfyll till färdig marknivå. Komprimera efter 300 mm fyllning av sand.

5. **Gör besiktning** innan lekredskapet tas i bruk enligt protokoll som medföljer i förpackningen. Protokollet bör dokumenteras. Glöm inte att hindra tillträde till dess att lekplatsen är helt klar och avstädad.

CLIMBING FRAMES

1. Use the packing list to check that none of the required components are missing (p. 3)
2. Select the location for the playground unit carefully with due regard to the **safe distances** indicated by the manufacturer (p. 5).
 - *Level the ground. Make the necessary excavations (p. 4). Select the orientation of the playground unit with due regard to potential exposure to intense sunlight or prevailing winds.
 - * A suitable surface is 30 cm thick layer of coarse sand with a grain size of 0,2 to 2 mm or gravel with a grain size of 2 to 8 mm. If the area is exposed to hard winds, the use of small round pebbles is recommended. If you use rubber tiles, observe carefully the safety and other instructions given by the manufacturer.
 - *Fasten the foundation feet to the posts.
3. The instructions for the erection of the climbing unit are shown on page 6. Select the right size of posts and fix the beams as instructed. When installing nets, bars, ladders, etc., follow the instructions given here. You will find the instructions and fixings for the components listed in the packing list (p. 3) and marked with symbol— in separate packages. **Comply with the dimensions indicated by the manufacturer.** The assembly of the complete unit is shown on the last page.
4. Check that the unit is correctly aligned and firmly supported. Fill the excavations and compact the earth at –300 mm.
5. **Carry out an acceptance inspection of the playground** unit using the inspection form contained in the package. File the form once completed. Remember that no access to the playground unit must be allowed until installation is completed and safe and the area is cleared of all tools.

KLETTERGERÜST

1. Prüfen Sie bitte anhand der Packliste die Vollständigkeit der Lieferung (Seite 3).
2. Berücksichtigen Sie bitte bei der Wahl des Standortes die empfohlenen **Sicherheitsabstände** (Seite 5).
 - *Planieren Sie den Untergrund und führen Sie die erforderlichen Grundausschachtungen durch (Seite 4). Bei der Wahl der Aufstellungsrichtung sollten mögliche Witterungseinflüsse wie starke Sonneneinstrahlung oder Wind berücksichtigt werden.
 - * Der beste Untergrund ist Sand, Korngröße 0,2–2 mm, oder Kies, Korngröße 2–8 mm. Die Schichtstärke sollte ca. 30 cm betragen. In windigen Gebieten wird Kies empfohlen. Falls Fallschutzplatten verwendet werden, sind die entsprechenden Einbauanleitungen und Hinweise des jeweiligen Herstellers genau zu beachten.
 - *Montieren Sie die Pfostenschuhe an die Pfosten.
3. Die Aufstellung des Grundgerüsts erfolgt gemäß den Hinweisen auf Seite 6—>. Die Wahl der Pfosten erfolgt anhand der aufgedruckten Artikelnummern. Befestigen Sie die Querbalken gemäß Anleitung. Befestigen Sie die Netze, Stangen, Strickleitern usw. nach der Teilmontageanleitung. Die in der Packliste (Seite 3) mit  markierten Teile und Befestigungsmaterialien, finden Sie in separater Verpackung. Befolgen Sie bitte die Maßangaben der Anleitung. Auf der letzten Seite ist die Montage des ganzen Spielgerätes beschrieben.
4. Überprüfen Sie den waagerechten und senkrechten Stand des Spielgerätes. Füllen Sie die Löcher um die Pfosten auf und verdichten Sie diese in 300 mm.
5. **Führen Sie** vor der Inbetriebnahme des Spielgerätes **die Gebrauchsabnahmeprüfung nach dem Protokoll durch**, das der Packung beigelegt ist. Das Protokoll sollte dokumentiert werden. Beachten Sie im eigenen Interesse, daß der Spielplatz erst dann in Betrieb genommen werden kann, wenn alle Gefahrenpunkte beseitigt und alle Arbeitsgeräte entfernt worden sind.

CADRES À GRIMBER

1. Vérifier à l'aide de la liste des pièces contenues dans l'emballage que l'on a reçu toutes les pièces nécessaires (page 3).

2. Choisir l'emplacement pour l'équipement de jeu en tenant compte des distances de sécurité recommandées par le fabricant (page 5).

*Egaliser la surface. Creuser les fosses nécessaires (page 4). Lorsque l'on choisit l'orientation de l'équipement de jeu, tenir compte de son exposition éventuelle au soleil ou au vent.

*La surface appropriée est une couche d'environ 30 cm de sable dont les granules ont de 0,2 à 2 mm ou gravier dont les granules ont de 2 à 8 mm. Les petites pierres rondes sont recommandées pour les régions très exposées au vent. Si l'on utilise des dalles de sécurité comme support, suivre les instructions de montage du fabricant.

*Monter les pieds de fondation sur les poteaux.





3. Les instructions de montage de l'équipement se trouvent à la page 6 et aux pages suivantes. Choisir les poteaux de la bonne longueur et monter les poutres conformément aux instructions. Monter les filets, les barres, les échelles, etc., conformément à cette notice et aux instructions de montage des pièces.

Les instructions et l'équipement de fixation des pièces indiquées par  sur la liste des pièces contenues dans l'emballage (page 3) se trouvent dans des emballages séparés. Observer les mesures indiquées par le fabricant. L'assemblage de l'équipement du jeu entier est indiqué à la dernière page.

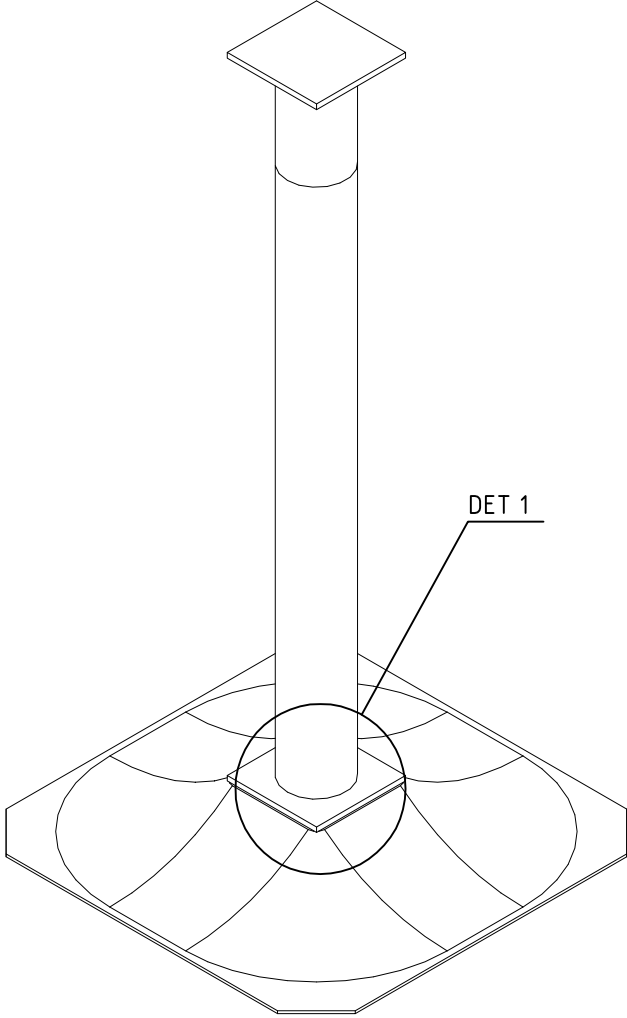
4. Vérifier que l'équipement du jeu est droit et que sa fondation est solide. Comblé et compacter les trous sur un minimum de 300 mm et reboucher.

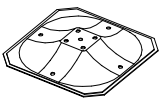
5. Effectuer avant la mise en service un contrôle de mise en service conformément au protocole qui se trouve dans l'emballage. Le protocole doit être conservé. Ne pas oublier que l'accès à l'aire de jeu doit être interdit jusqu'à ce que celle-ci soit achevée et sûre et que tous les outils et gravats soient enlevés.



①	909511	PCS	②	909519	PCS
		1			1
③	909637	PCS	④	909638	PCS
		4			8
	M10			Ø20/10.5	
⑤	909639	PCS			PCS
		4			
	M10x25				
		PCS			PCS
		PCS			PCS
		PCS			PCS
		PCS			PCS
		PCS			PCS

DET 1

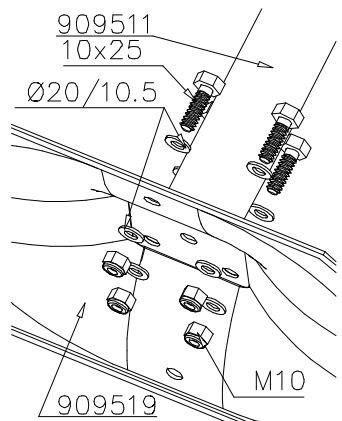

LAPPSET®
DEEP FOUNDATION

FOOT

DATE: 13.3.2014

4A



LAPPSET®
BETON FOUNDATION

FOOT

DATE: 27.10.2015

1(1)

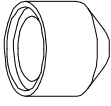
② 905104	PCS		PCS
	4		
 M10	PCS		PCS



905104



**Tuotekyltti tulee tuotteen mukana yhdellä seuraavista tavoista:****1) Metallinen tuotekyltti ja kiinnitysruuvit**

- Kiinnitä tuotekyltti ruuveilla tolppaan noin 2 metrin korkeuteen kuvan 1 mukaisesti.

2) Tuotekylttitarra

- Puhdista maalattu metalli- tai vaneripinta pölystä ja kosteudesta. Liimaa tarra kuvan 2 mukaisesti.
- Huom. Älä kiinnitä tarraa karheapintaiseen laminaattiin tai maalattuun puuhun.

Vår produktmärkning levereras på ett av följande sätt:**1) Produktskylt i metall**

- Fäst skylten med de medföljande skruvarna

2) Självhäftande produktetikett

- Rengör den pulverlackerade metallytan eller laminatyten så att den blir fri från smuts och fukt. Fäst etiketten enligt fig. 2.
- Obs! Fäst ej etiketten på detaljer med skrovlig yta eller på målat trä.

Product label is delivered by one of following ways:**1) Metal product label and screws**

- Fasten the label with screws.

2) Label sticker

- Clean the painted metal or plywood surface from dirt and moisture. Fasten the sticker as shown in the figure 2.
- Note. Do not attach the sticker to rough surfaced laminate or painted wood.

La plaque d'informations produit est livrée sous l'une de ces 3 formes :**1) Plaque métallique et vis**

- Fixez la plaque à l'aide des vis.

2) Etiquette autocollante

- Avant de coller l'étiquette, nettoyez le composant métallique peint ou la plaque de contreplaqué, de toute saleté. La surface doit être sèche (voir image 2).
- Attention, ne pas coller l'étiquette sur une surface lamellé-collée irrégulière ou sur du bois peint.



Die Auslieferung des Produktaufklebers erfolgt auf eine dieser Arten:**1) Produkt-Schild aus Metall incl. Schrauben**

- Die Befestigung des Schildes erfolgt mittels der Schrauben.

2) Aufkleber

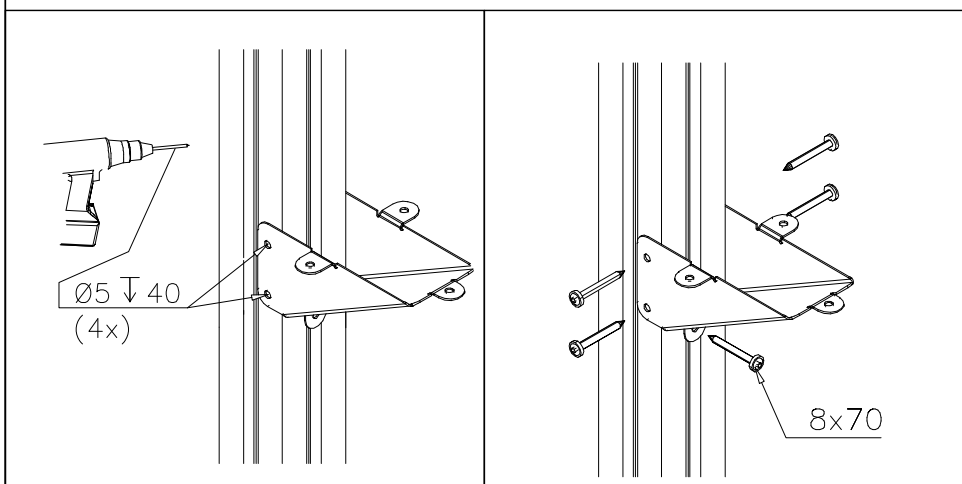
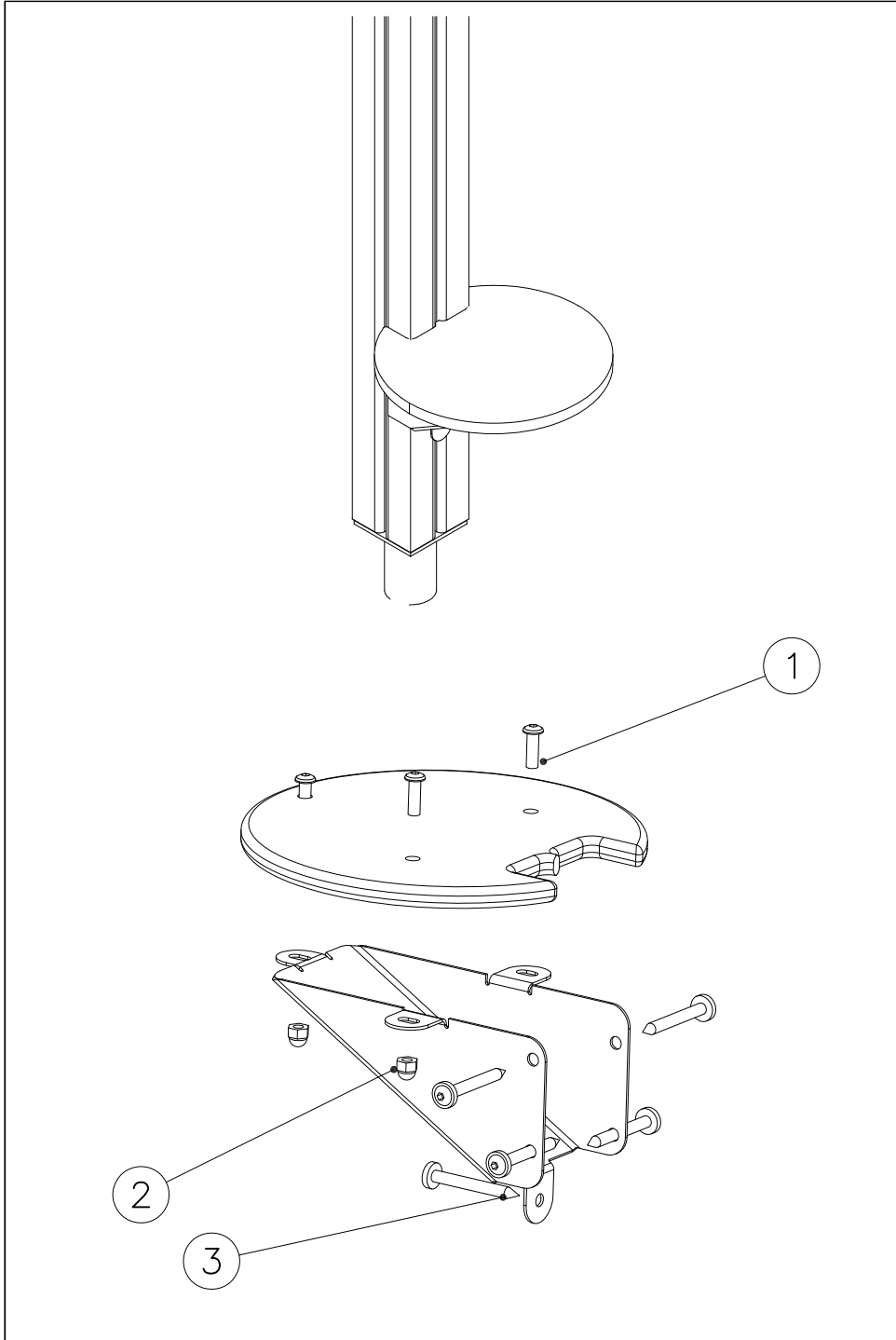
- Entfernen Sie zunächst Schmutz und Feuchtigkeit vom lackierten Metall bzw. von der Holzoberfläche und bringen Sie den Aufkleber wie im Bild oben rechts beschrieben auf den gesäuberten Untergrund auf.
- Beachten Sie: Bringen Sie den Aufkleber nicht auf raues laminiertes oder lackiertes Holz an.

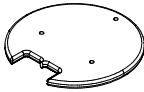
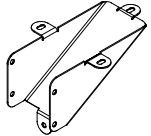

①	909850	PCS	②	909633	PCS
		3			3
					
	M8x25			M8	
③	900240	PCS			PCS
		5			
					
	Ø8x70				
		PCS			PCS
○	707696	PCS	○	902086	PCS
		1			1
					
	15x265x275			148x172x254	
		PCS			PCS
		PCS			PCS
		PCS			PCS
		PCS			PCS