

# LAPPSET®

## FINNO



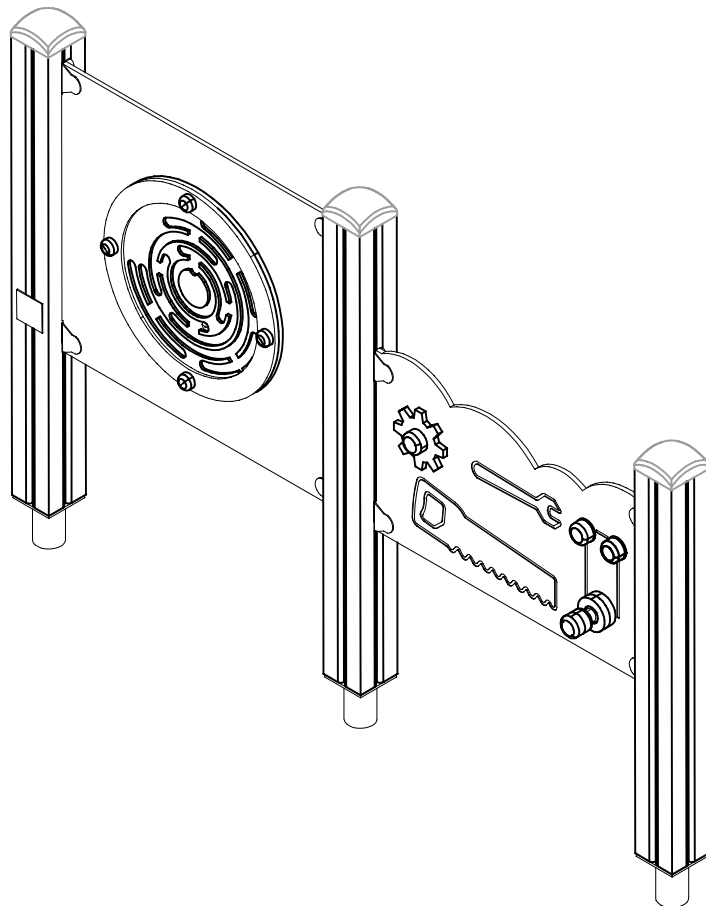

A SENNUSOHJE  
MONTERINGSANSVISNING  
INSTALLATION INSTRUCTION  
AUFBAUANLEITUNG  
NOTICE D'INSTALLATION

DATE: 18.9.2024

### Q18460

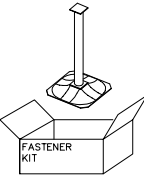
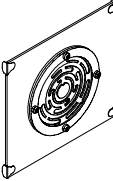
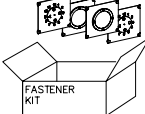
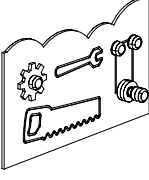
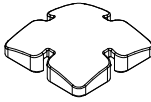
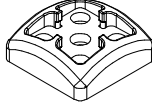

DATE: 18.9.2024

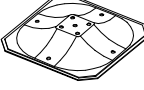
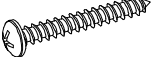
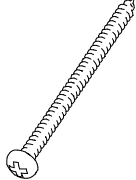
702286  65x65	PCS 1	706466-602  93x93x1025	PCS 2	706499-602  93x93x860	PCS 1	706531  FASTENER KIT	PCS 3	706766-705 	PCS 1	706778  FASTENER KIT	PCS 2
709405-705  130x420x702	PCS 1	905138  GRAY	PCS 3	905196  GRAY	PCS 3	909511  90x90x650	PCS 3	909519  50x380x380	PCS 3	980114  Ø4x20	PCS 4
980131  Ø6x60	PCS 12		PCS		PCS		PCS		PCS		PCS
	PCS		PCS		PCS		PCS		PCS		PCS
	PCS		PCS		PCS		PCS		PCS		PCS
	PCS		PCS		PCS		PCS		PCS		PCS
	PCS		PCS		PCS		PCS		PCS		PCS

