

LAPPSET®

SPORT







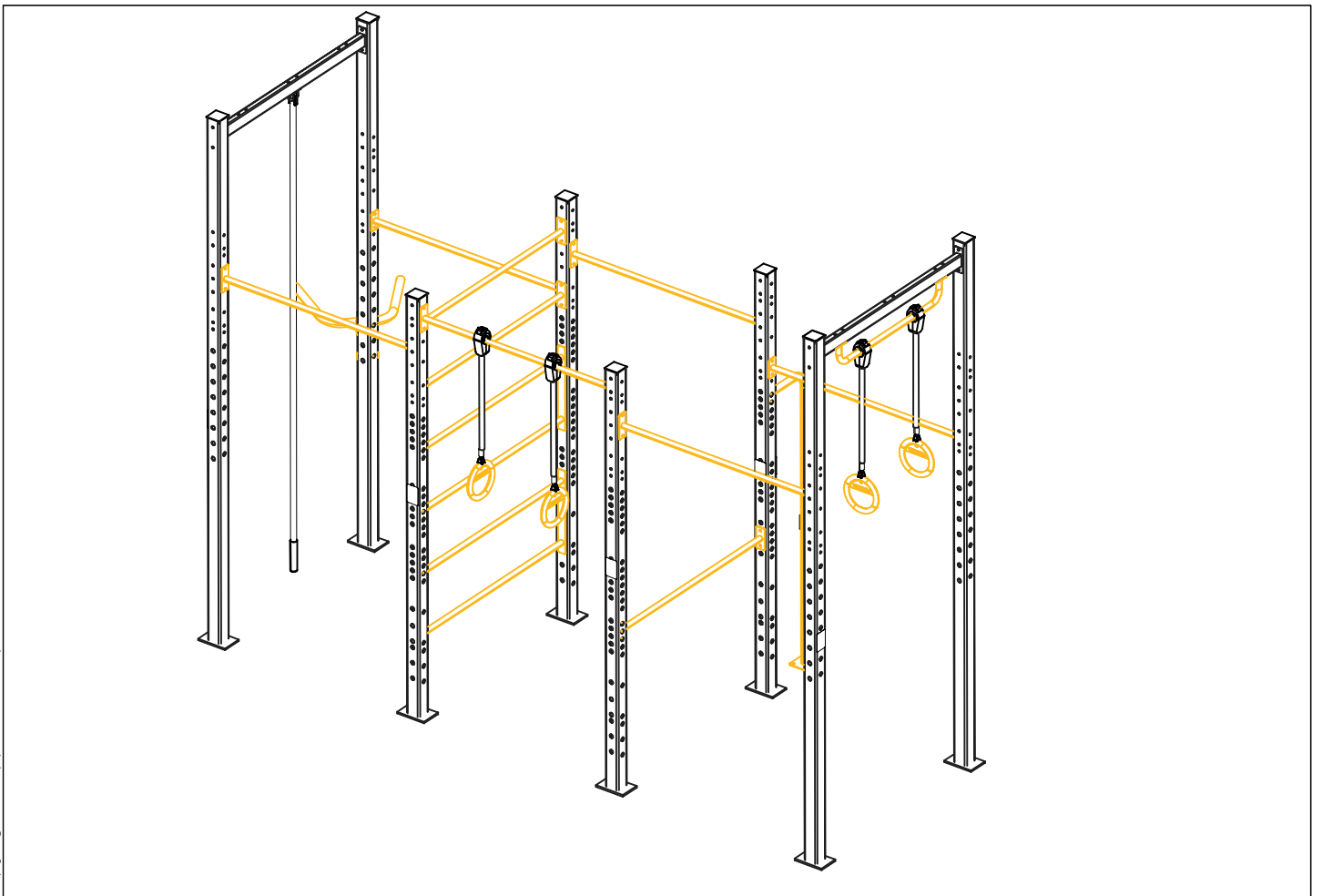





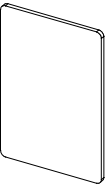
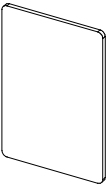
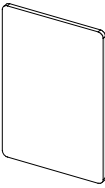

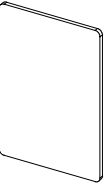
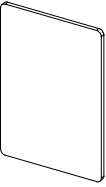
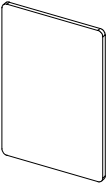



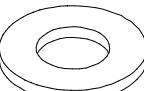
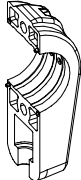
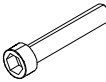

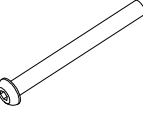
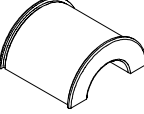
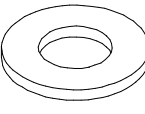

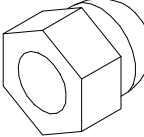
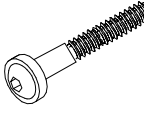

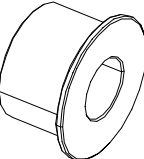
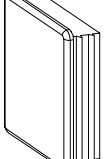
ASENNUSOHJE
MONTERINGSANSVISNING
INSTALLATION INSTRUCTION
AUFBAUANLEITUNG
NOTICE D'INSTALLATION

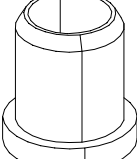
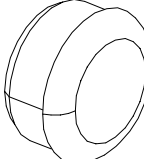
DATE: 18.10.2024

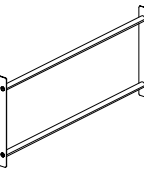
Q18445

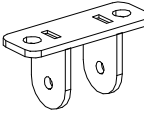

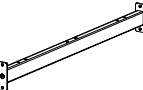
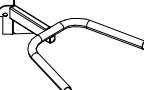
DATE: 18.10.2024

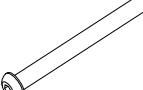
702341  90x50	PCS 1	708811  Ø32x3050	PCS 1	709733  118x78	PCS 1	709734  118x78	PCS 1	709736  118x78	PCS 1	709737  118x78	PCS 1
709738  118x78	PCS 1	709739  118x78	PCS 1	710040  118x78	PCS 1	710041  118x78	PCS 1	710486  Ø16x974	PCS 4	711405  118x78	PCS 1
900965  M10	PCS 74	901302  Ø20/10.5x2	PCS 126	902195  150x50x50	PCS 8	902232  M10x55	PCS 4	902233  M10x30	PCS 4	904450  M16x170	PCS 32
904917  M10x100	PCS 6	906006  Ø64/36,4x59	PCS 8	909256  Ø16/8.4x1.6	PCS 5	909628  M10x100	PCS 4	909633  M8	PCS 1	909867  M8x70	PCS 1
910368-224  1315	PCS 2	910376  Ø30x17	PCS 36	910405  90x90x30	PCS 9	910410-222  90x90x2720	PCS 4	910415  Ø16/12,5-14x17	PCS 208	910416  Ø48/43-45x24	PCS 2
910427-222  90x90x3400	PCS 4	910442-224  1315	PCS 2	910444-224  1315x160	PCS 6	910447-224  1315x160	PCS 1	910448-222  110x38x55	PCS 1	910455-224  1315	PCS 1
910614-222  1315	PCS 2	910619-224  45°	PCS 1	910622-224  1315	PCS 1	911149  M10x110	PCS 60		PCS		PCS

- EN/AS Impact Area 42 m²
- Falling Space 42 m²
Max Falling Height 2380 mm

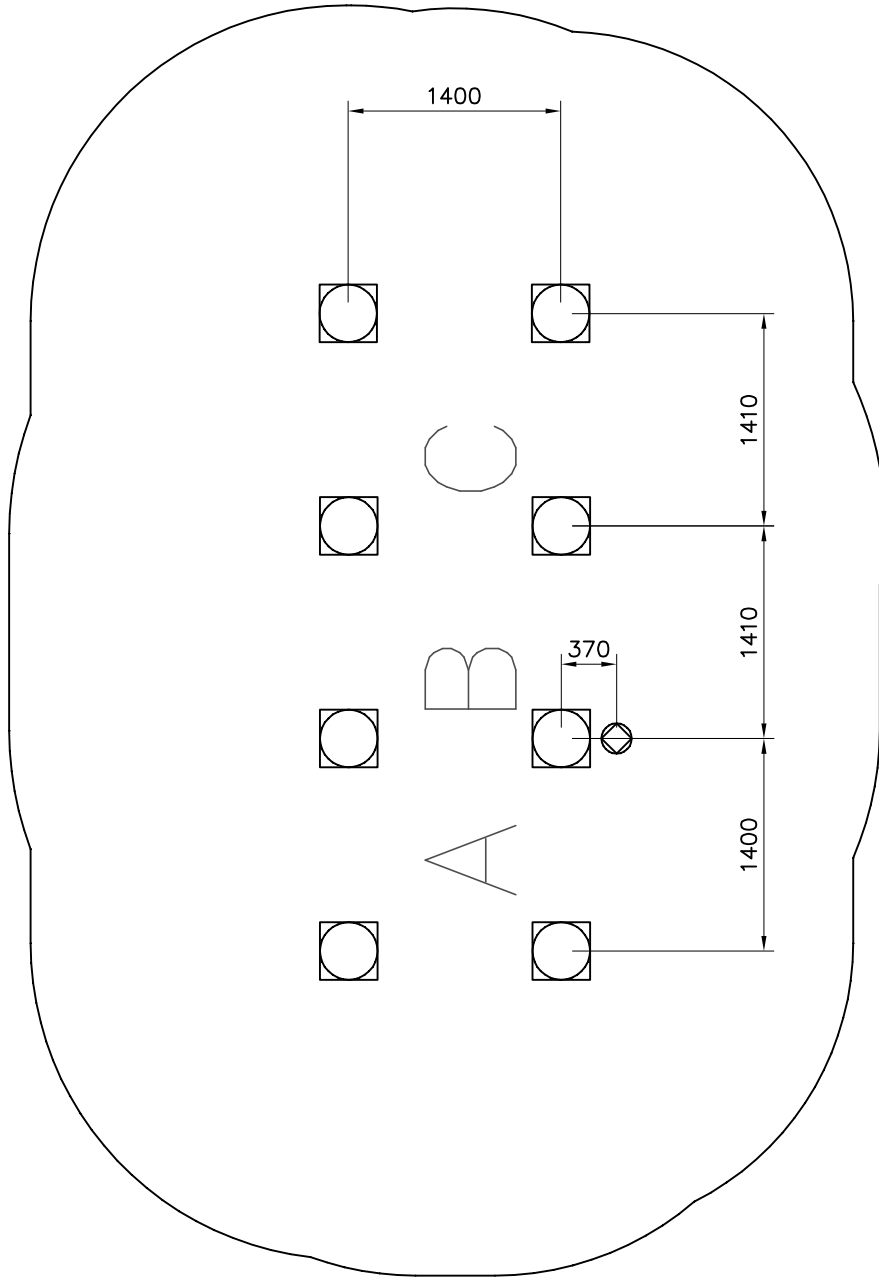

Ø16 ↓ > 130

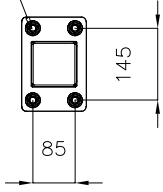

- EN/AS Impact Area 42 m²
- - - Falling Space 42 m²
Max Falling Height 2380 mm

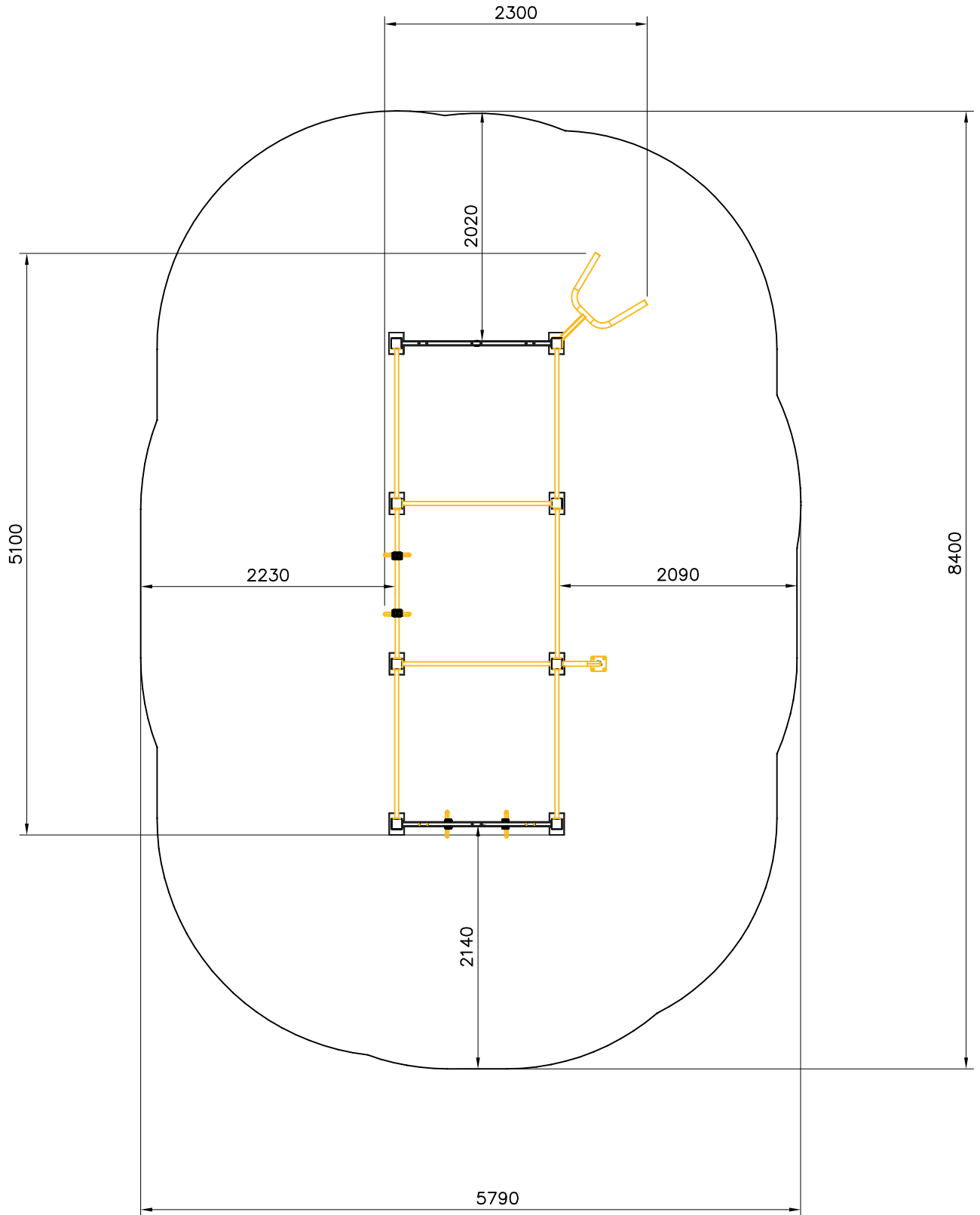
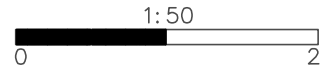

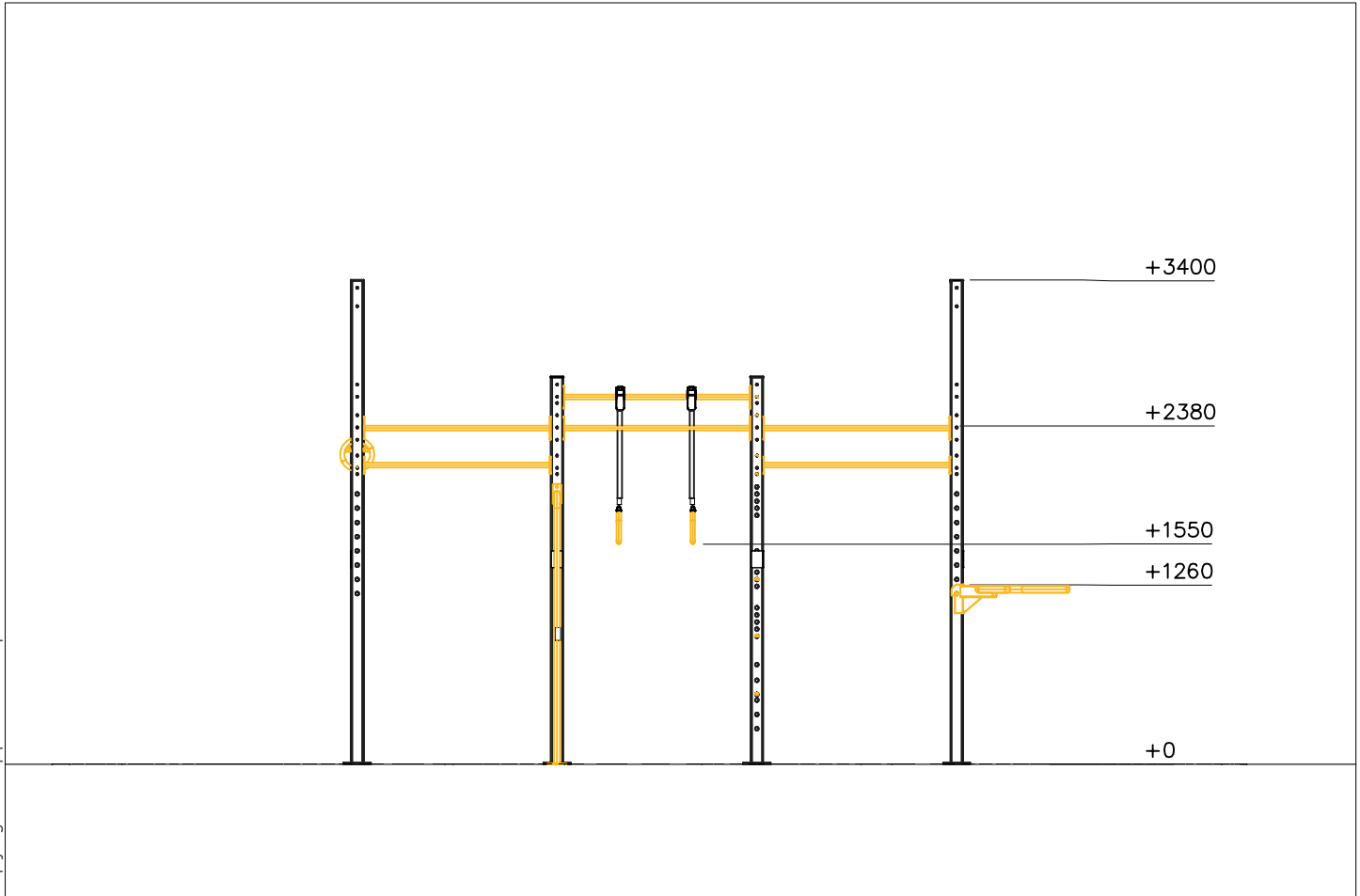
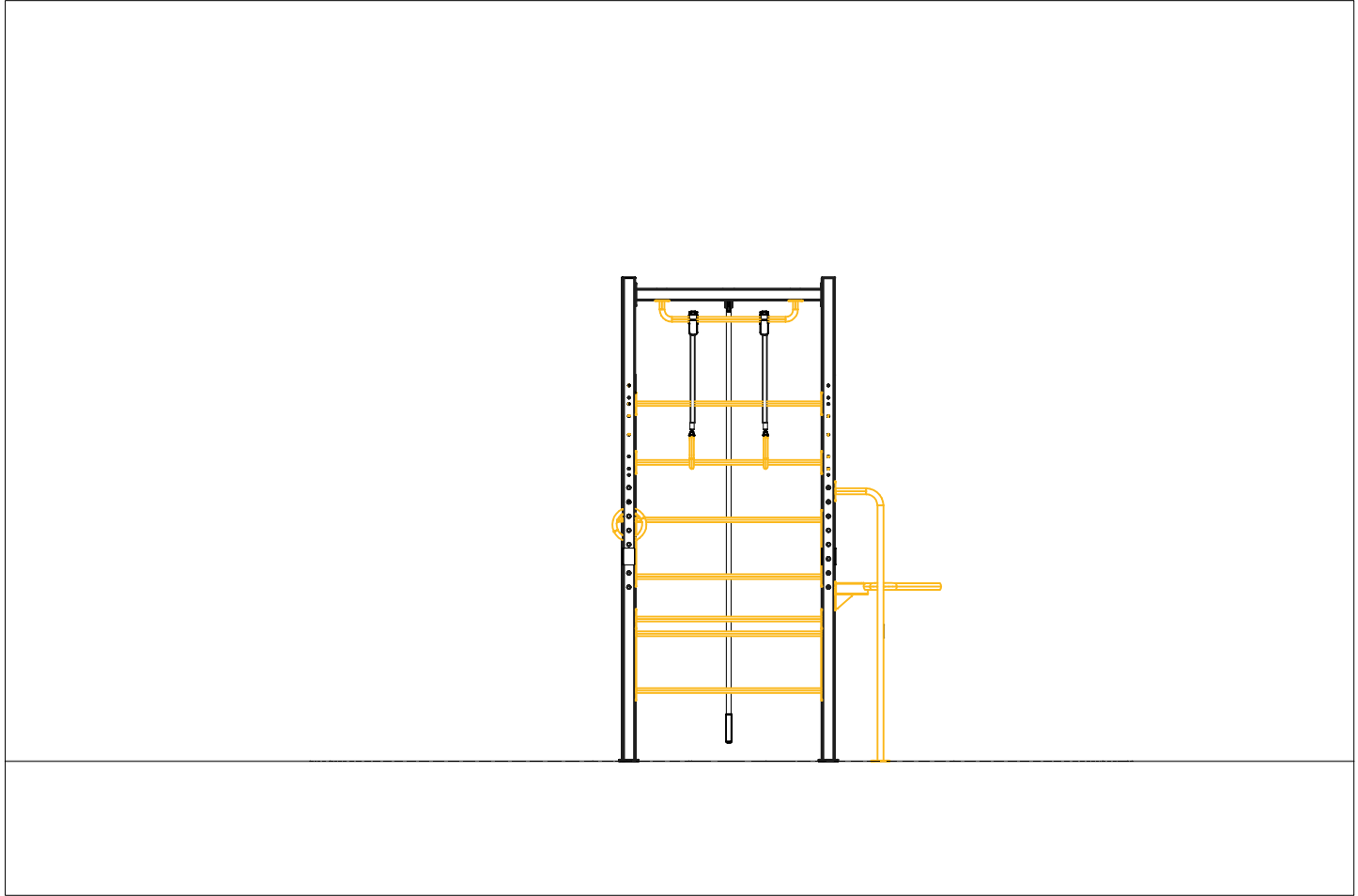

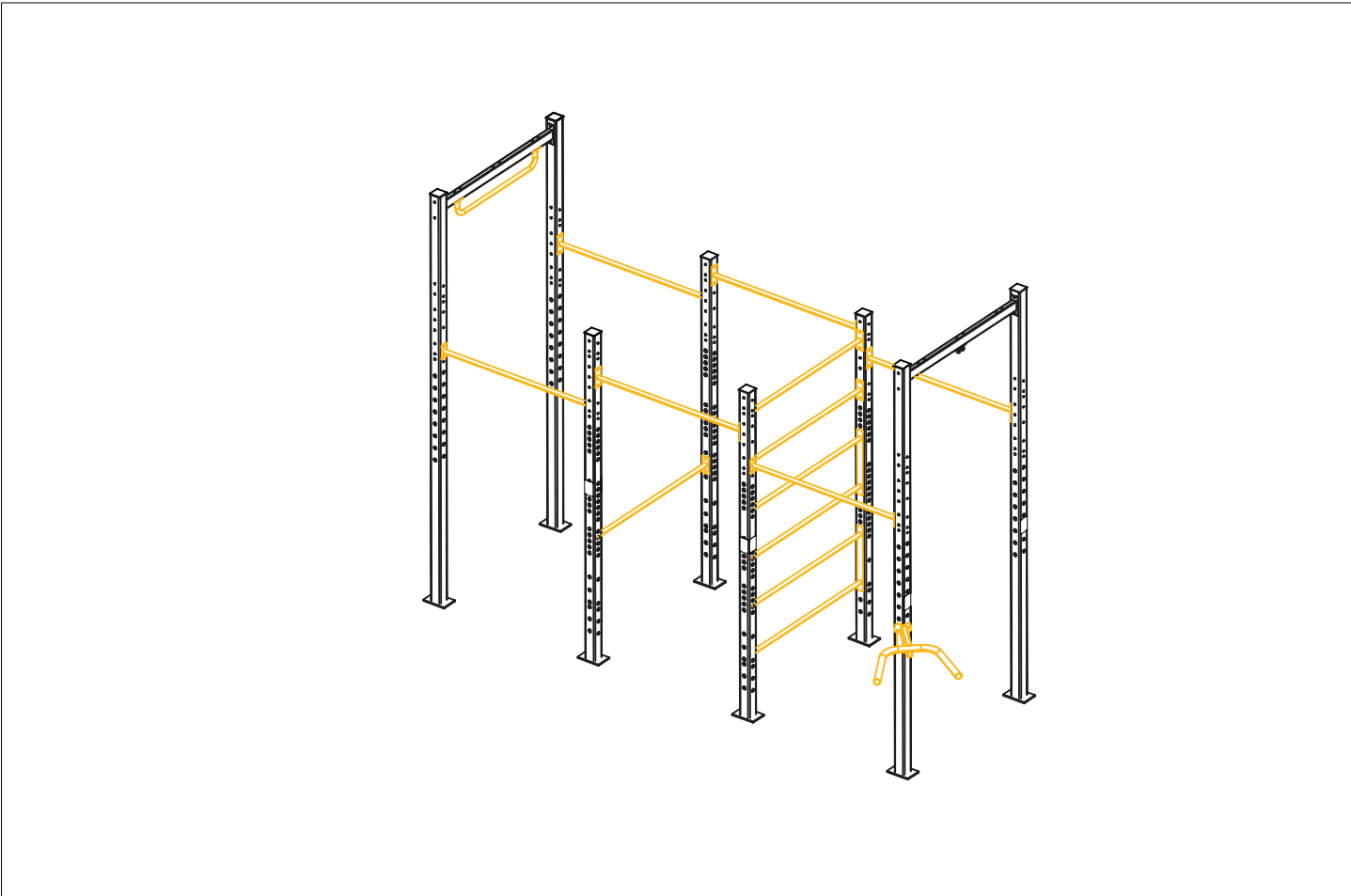
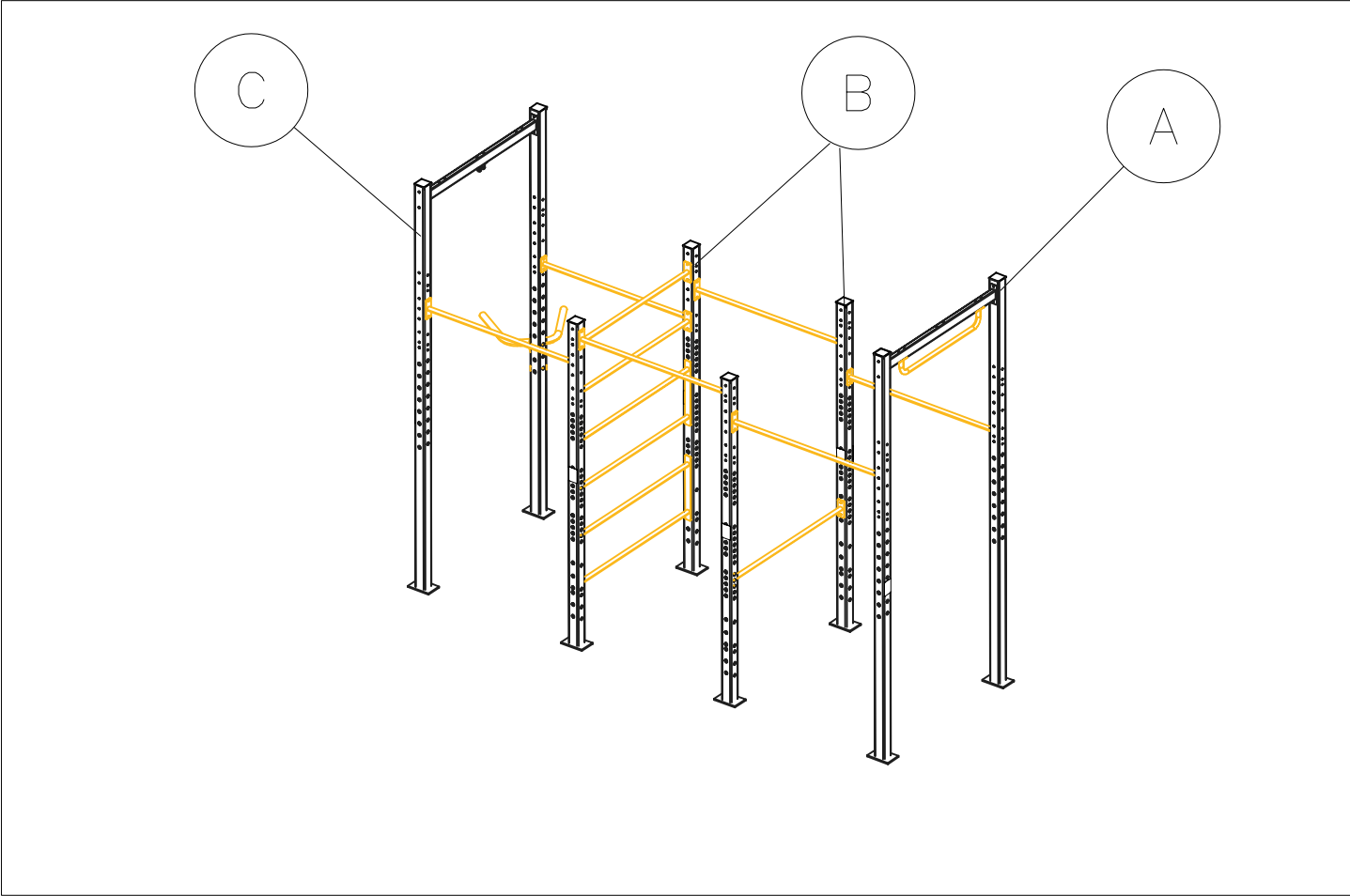

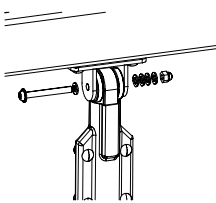
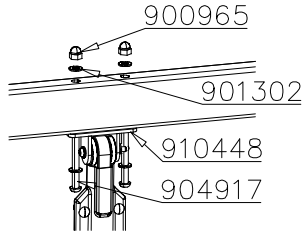
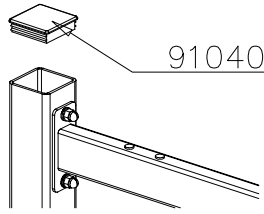
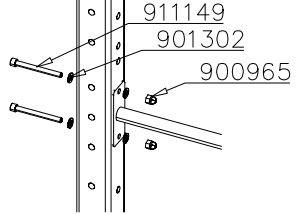
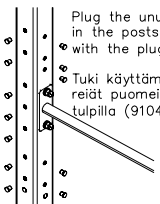
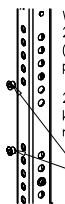
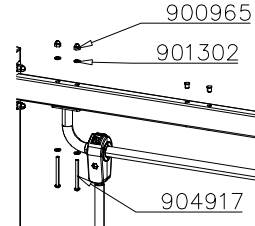
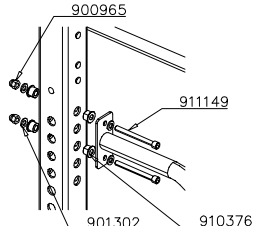
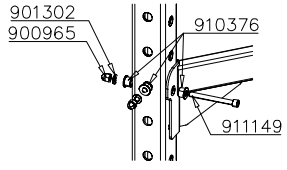
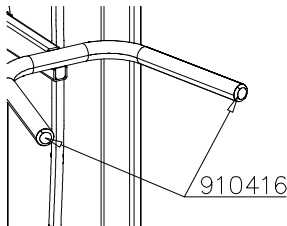
<p>DET 1</p> 	<p>DET 2</p> 	<p>DET 3</p> 	<p>DET 4</p> 
<p>DET 5</p>  <p>Plug the unused 13mm holes in the posts and beams with the plugs (910415)</p> <p>Tuki käyttämättömät 13mm reiät puomeissa ja tolpiissa tulpilla (910415)</p>	<p>DET 6</p>  <p>When installing elements in the 26mm holes use the bushings (910376) on both sides of the post</p> <p>26mm reikiin asennettaessa käytä puslia (910376) toipan molemmin puolin</p>	<p>DET 7</p> 	<p>DET 8</p> 
<p>DET 9</p> 	<p>DET 10</p> 		

DATE: 18.10.2024

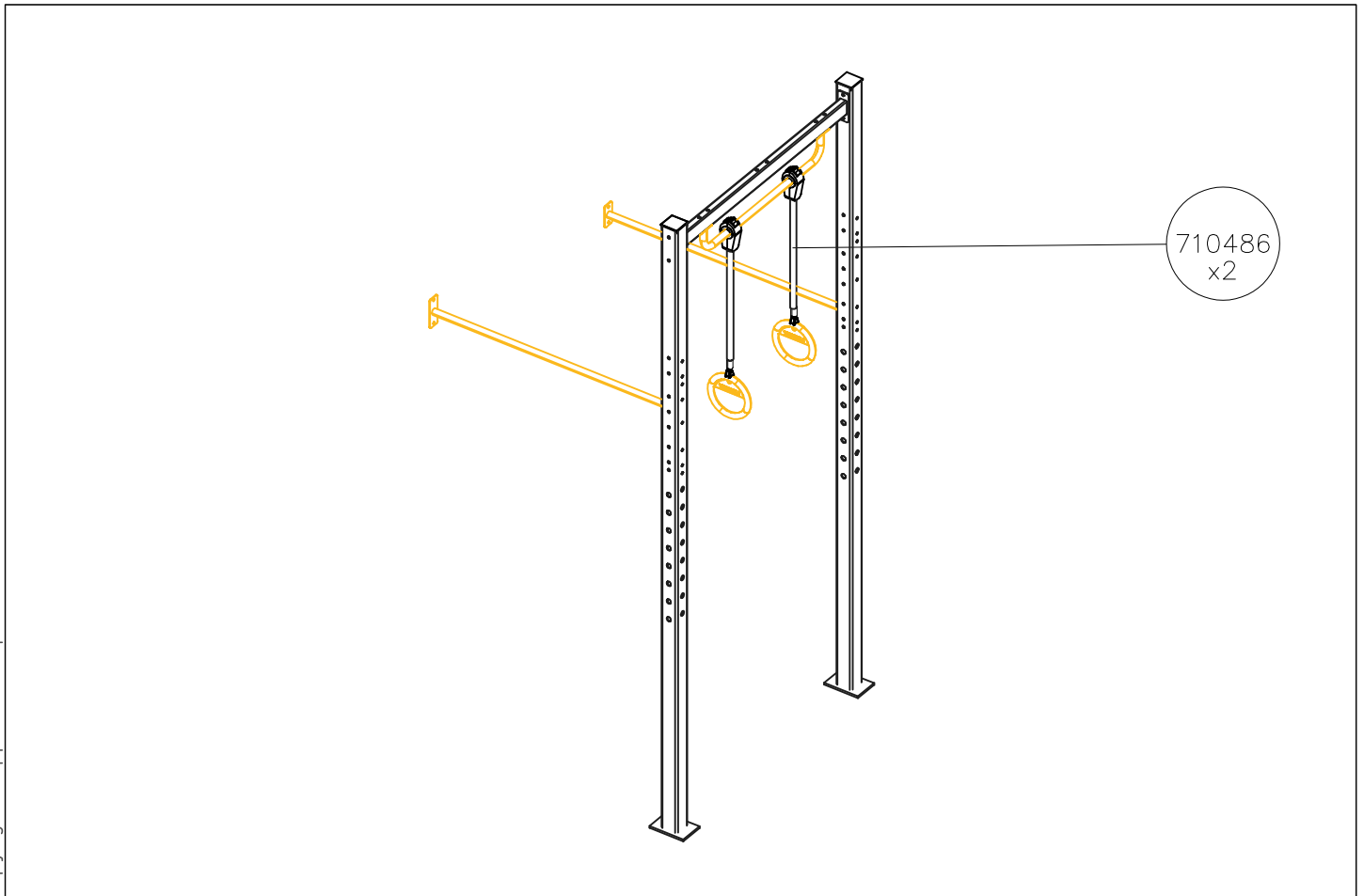
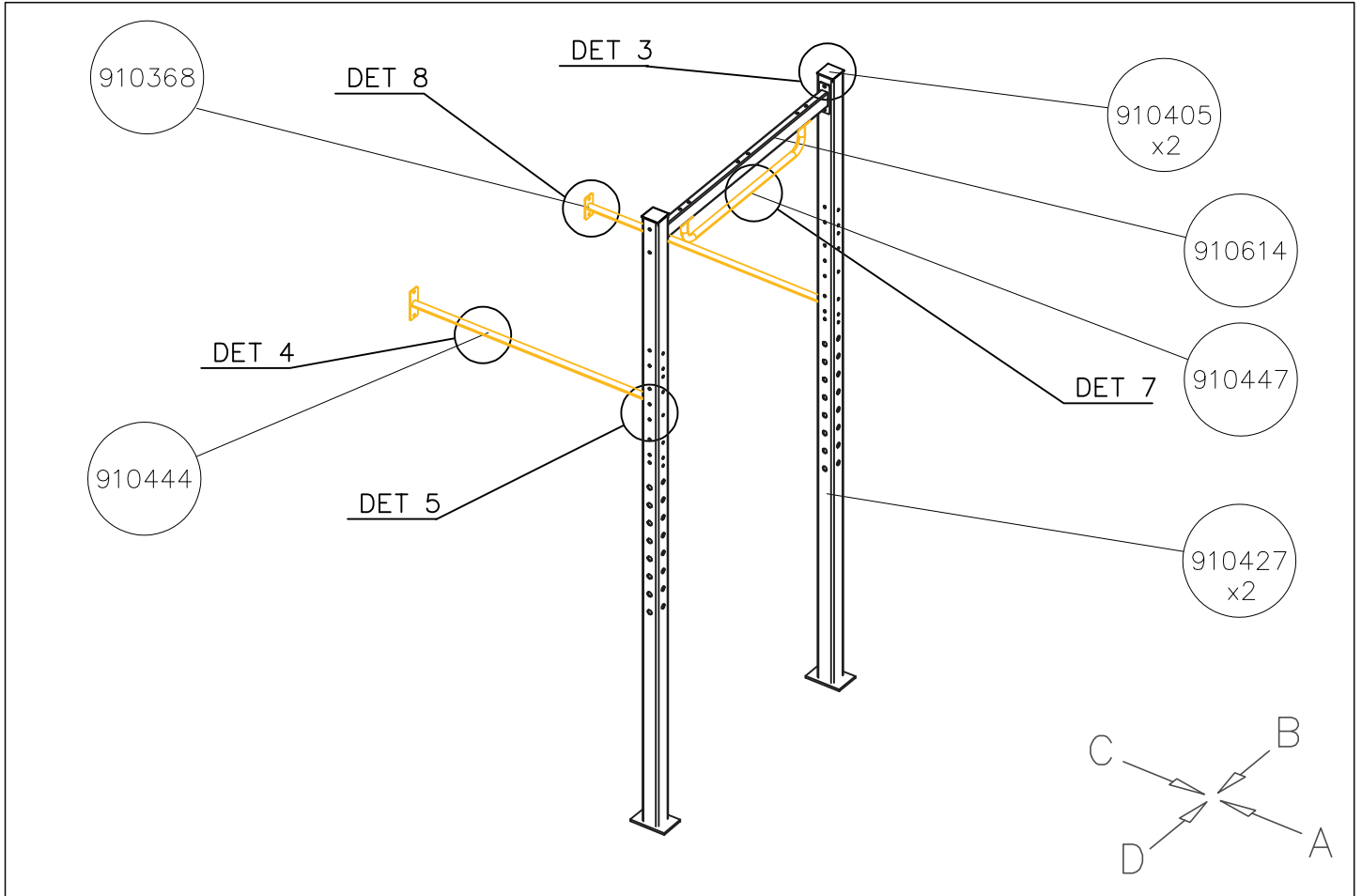

DATE: 18.10.2024

1: 50

A

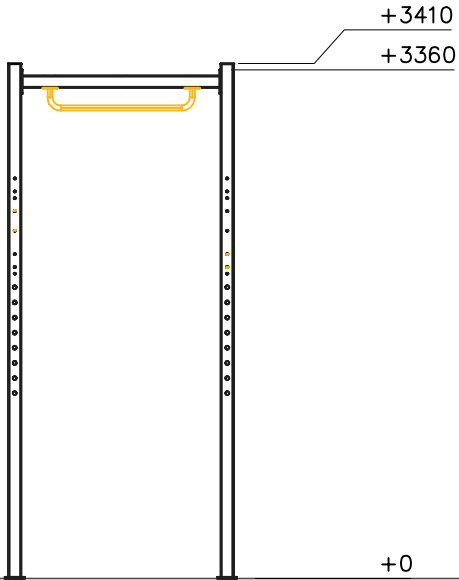

B

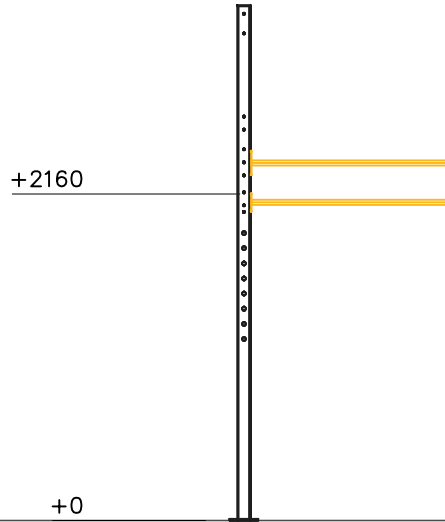

C

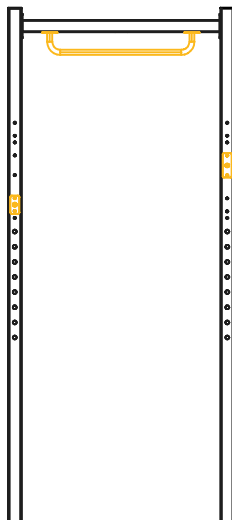

D

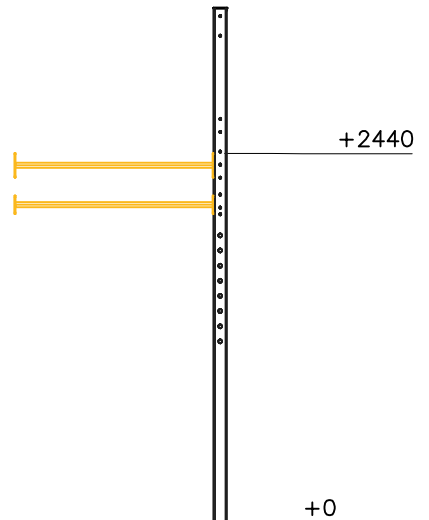

DATE: 18.10.2024

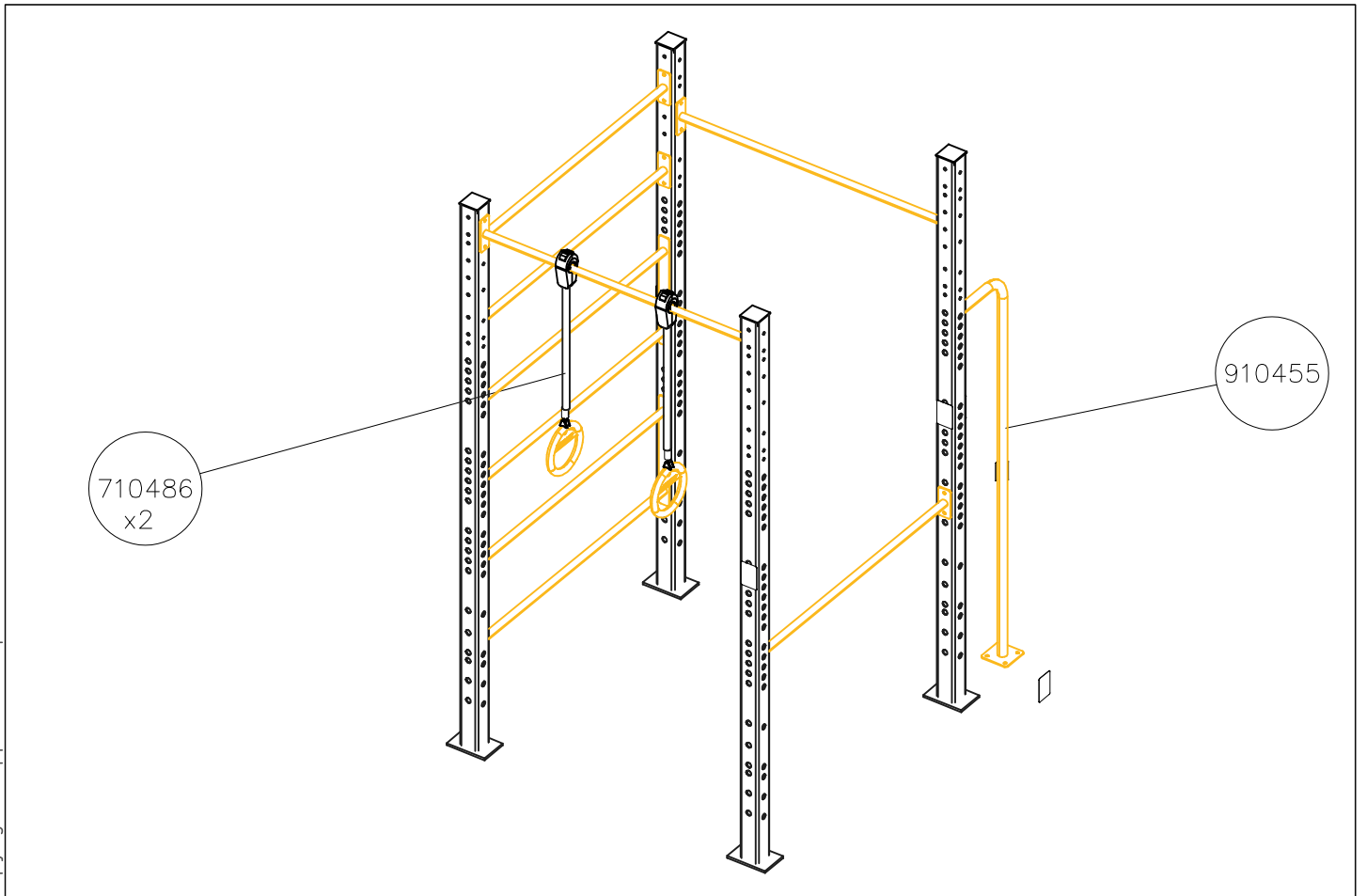
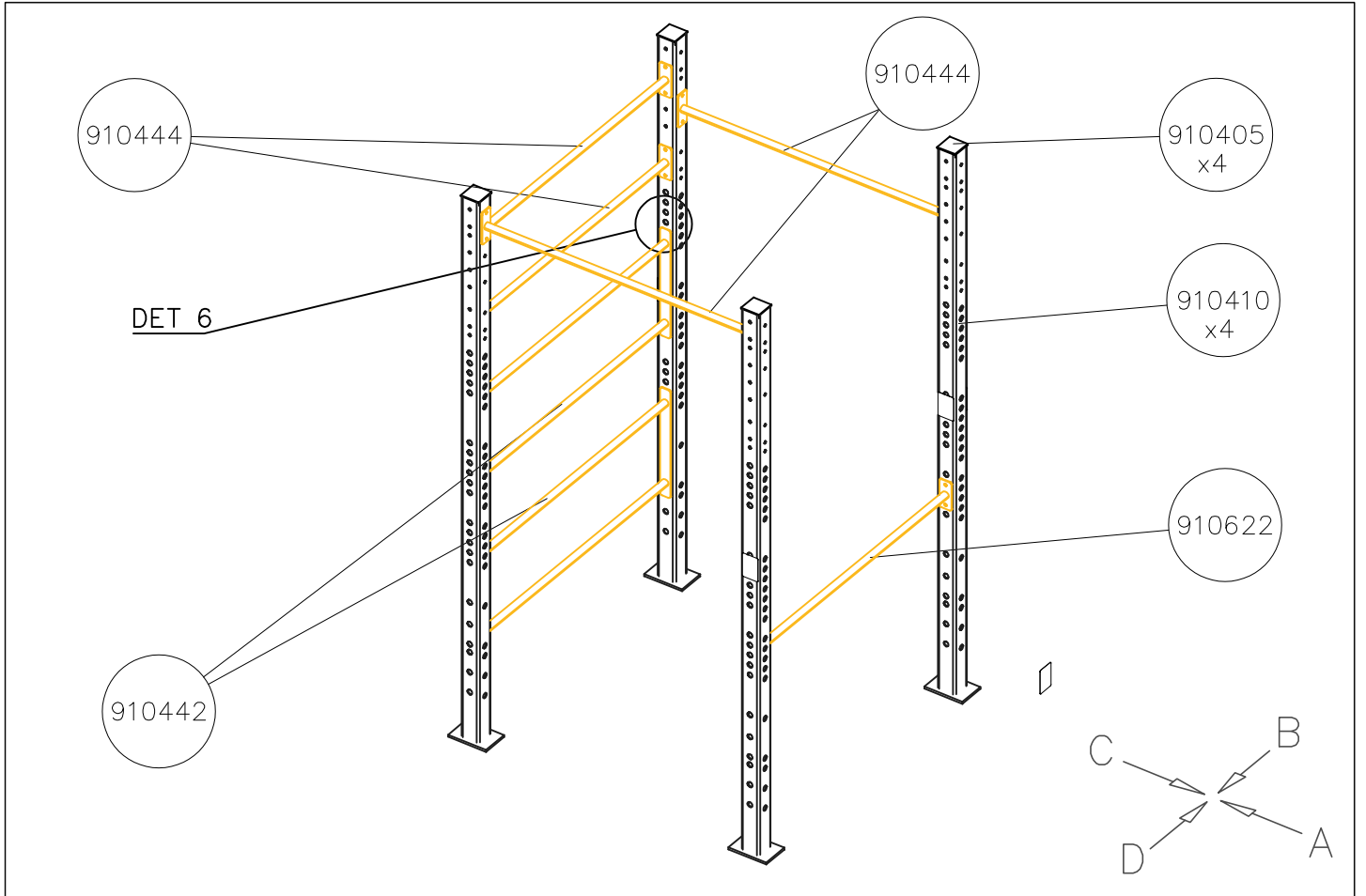

DATE: 18.10.2024

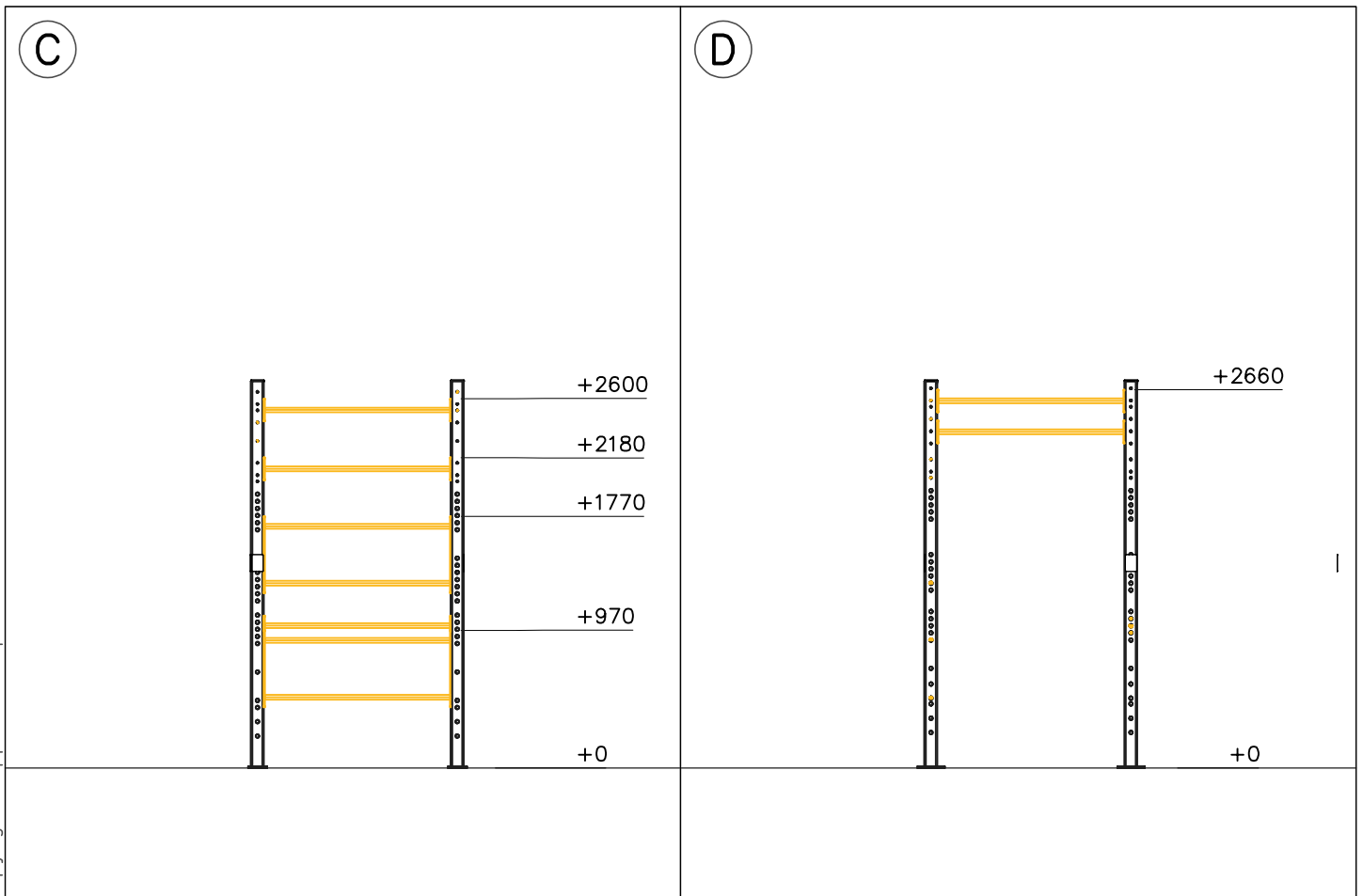
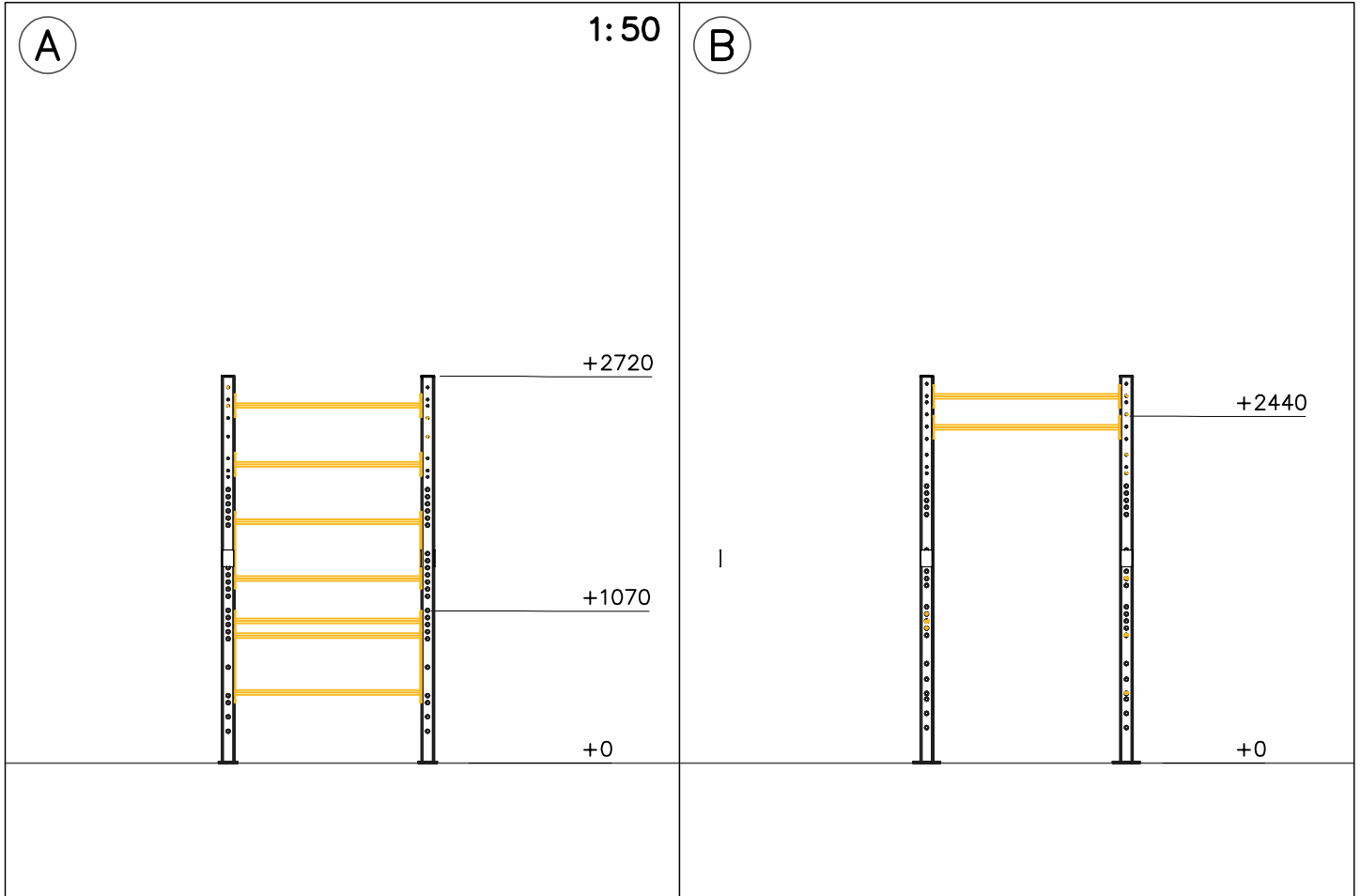

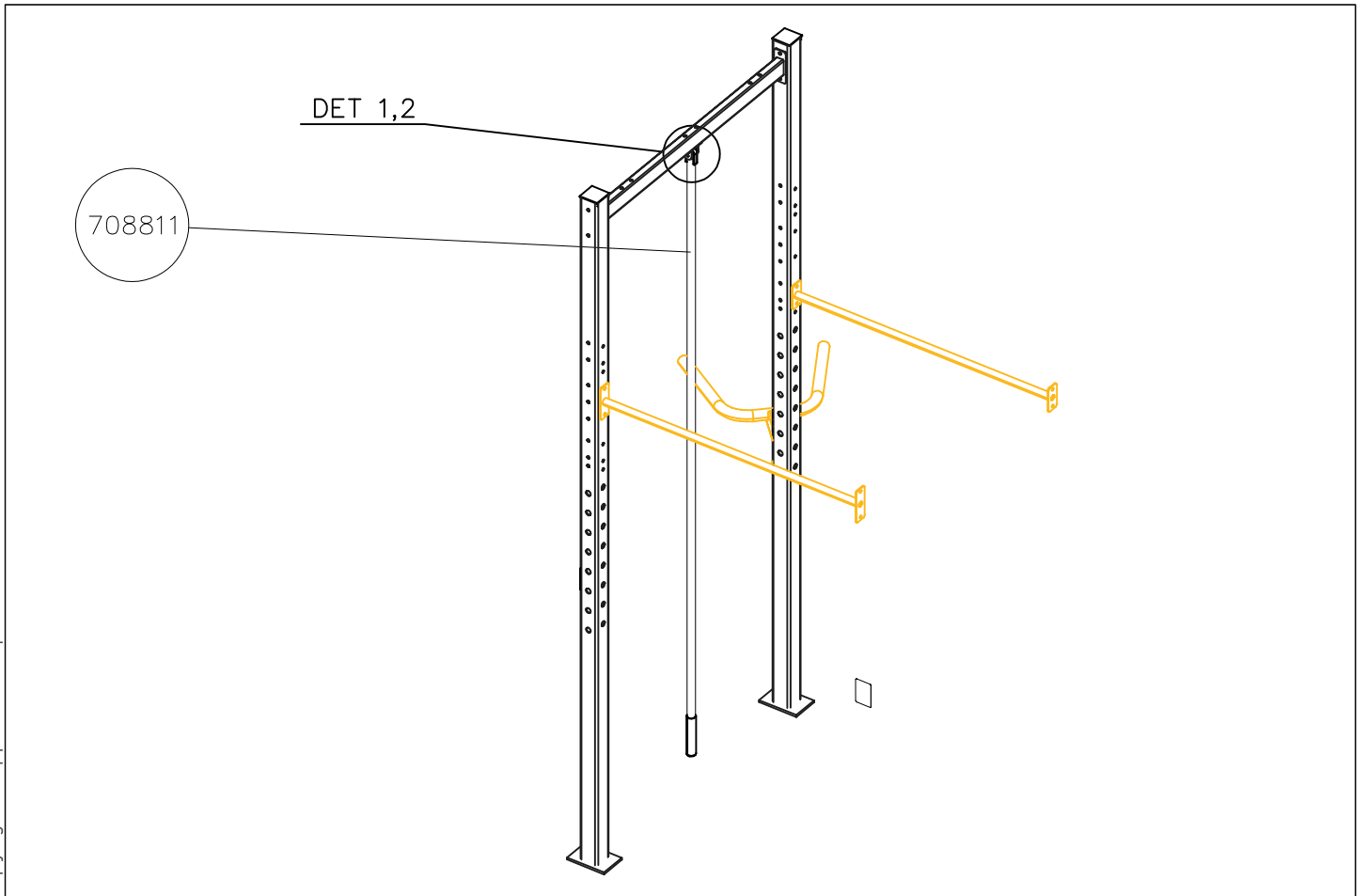
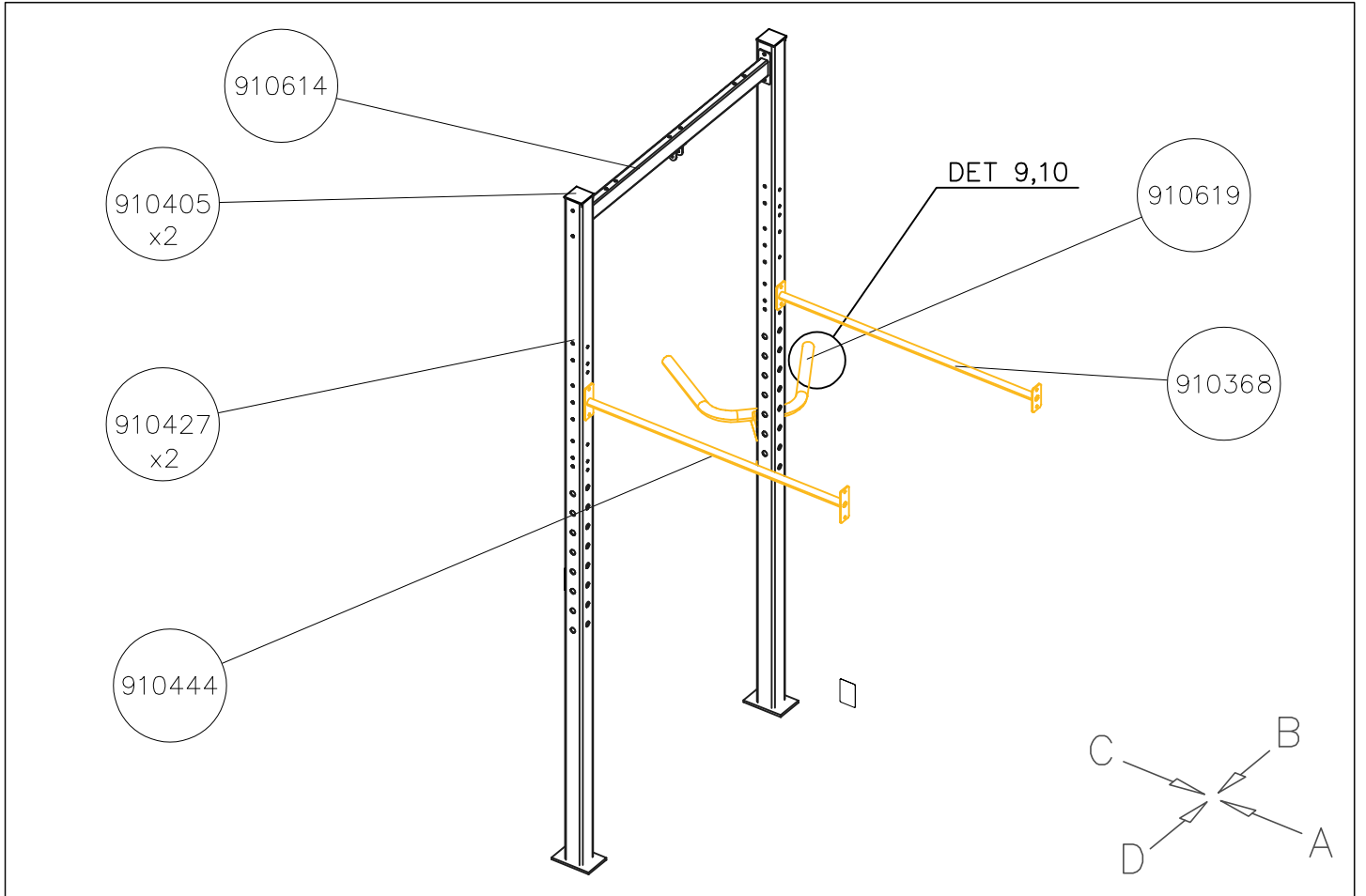

DATE: 18.10.2024

1:50

A

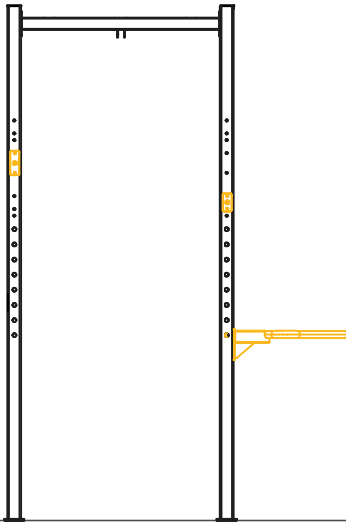

B

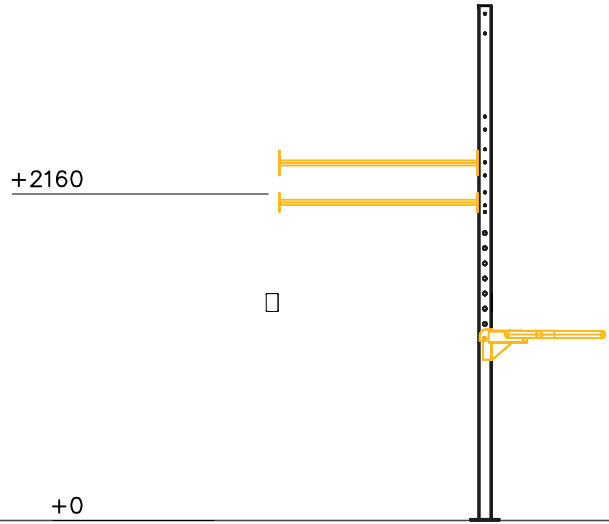

C

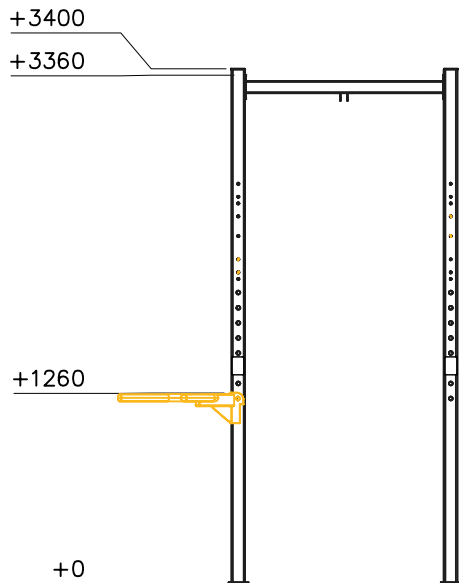

D

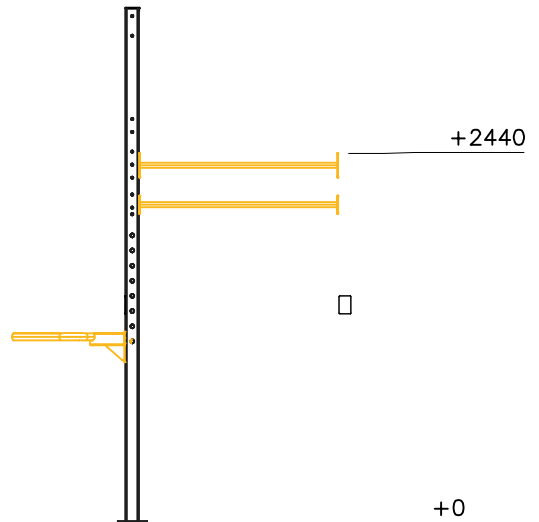

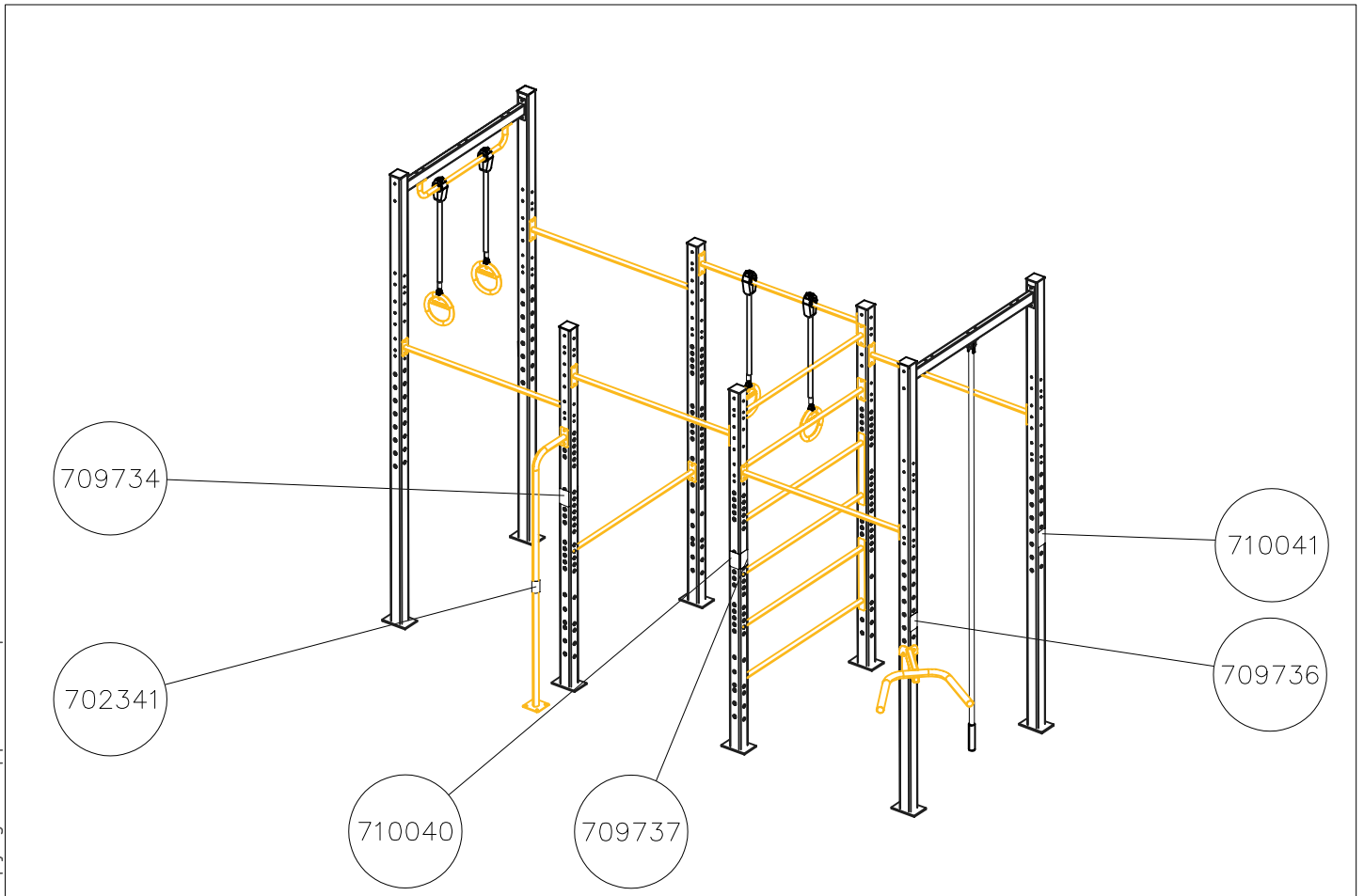
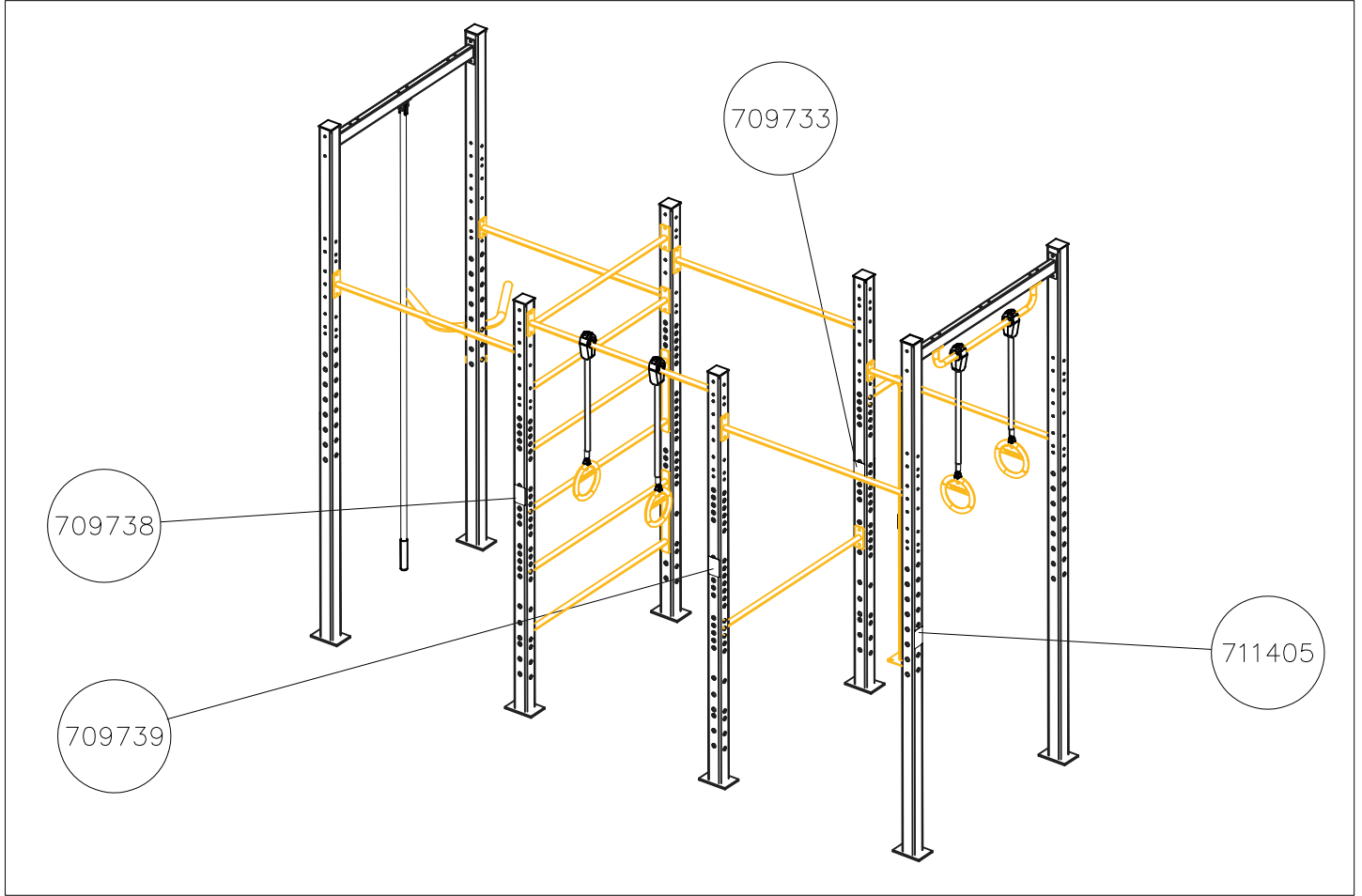

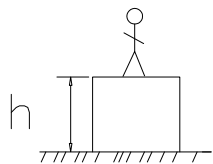

$h < 1000$

Totally hard surfaces or materials with very limited impact attenuating properties.

Totally hard surfaces.
E.g. concrete or asphalt



Case by case risk assessment is needed including e.g. evaluation whether there is forced movement, what is the intended exercise and where will the product be installed.

Materials with very limited impact attenuating properties.
E.g. wood



$h < 1200$

Materials with significant impact attenuating properties.

fine gravel 0–8 mm

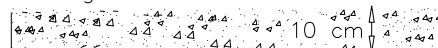

Unsorted sand/ topsoil

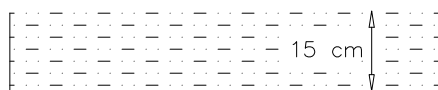

$h < 1500$

Lawn



$h < 3000$

Loose fill material

E.g.
sand/gravel 0,25...8 mm $D_{60}/D_{10} < 3,0$
Woodchips 5...30 mm
bark 20...80 mm

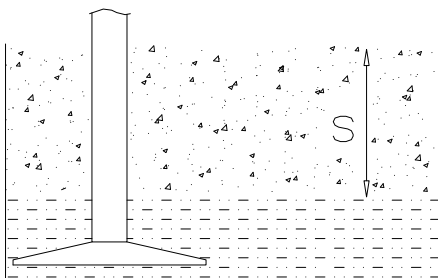

\underline{S}	\underline{h}
30 cm	$< 2,0$ m
40 cm	$< 3,0$ m

Syntetic granulates

\underline{S}	\underline{h}
40 mm	$\sim > 1,2...1,3$ m
50 mm	$\sim > 1,5...1,7$ m
60 mm	$\sim > 1,8...2,0$ m
70 mm	$\sim > 2,1...2,5$ m

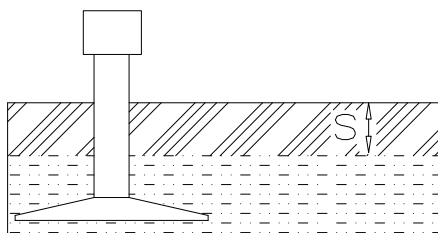

Note. For accurate values, see manufacturer's instructions.



Tuotekyltti tulee tuotteen mukana yhdellä seuraavista tavoista:

1) Metallinen tuotekyltti ja kiinnitysruuvit

- Kiinnitä tuotekyltti ruuveilla tolppaan noin 2 metrin korkeuteen kuvan 1 mukaisesti.

2) Tuotekyltitarra

- Puhdista maalattu metalli- tai vaneripinta pölystä ja kosteudesta. Liimaa tarra kuvan 2 mukaisesti.
- Huom. Älä kiinnitä tarraa karheapintaiseen laminaattiin tai maalattuun puuhun.

Vår produktmärkning levereras på ett av följande sätt:

1) Produktskylt i metall

- Fäst skylten med de medföljande skruvarna

2) Självhäftande produktetikett

- Rengör den pulverlackerade metallytan eller laminatyten så att den blir fri från smuts och fukt. Fäst etiketten enligt fig. 2.
- Obs! Fäst ej etiketten på detaljer med skrovlig yta eller på målat trä.

Product label is delivered by one of following ways:

1) Metal product label and screws

- Fasten the label with screws.

2) Label sticker

- Clean the painted metal or plywood surface from dirt and moisture. Fasten the sticker as shown in the figure 2.
- Note. Do not attach the sticker to rough surfaced laminate or painted wood.

La plaque d'informations produit est livrée sous l'une de ces 3 formes :

1) Plaque métallique et vis

- Fixez la plaque à l'aide des vis.

2) Etiquette autocollante

- Avant de coller l'étiquette, nettoyez le composant métallique peint ou la plaque de contreplaqué, de toute saleté. La surface doit être sèche (voir image 2).
- Attention, ne pas coller l'étiquette sur une surface lamellé-collée irrégulière ou sur du bois peint.

Die Auslieferung des Produktaufklebers erfolgt auf eine dieser Arten:

1) Produkt-Schild aus Metall incl. Schrauben

- Die Befestigung des Schildes erfolgt mittels der Schrauben.

2) Aufkleber

- Entfernen Sie zunächst Schmutz und Feuchtigkeit vom lackierten Metall bzw. von der Holzoberfläche und bringen Sie den Aufkleber wie im Bild oben rechts beschrieben auf den gesäuberten Untergrund auf.
- Beachten Sie: Bringen Sie den Aufkleber nicht auf raues laminiertes oder lackiertes Holz an.

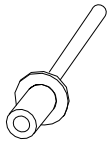
①	SIGN	PCS	②	905390	PCS
 118x78		1	 Ø4,8x28		4

