

Max Falling Height 1470mm

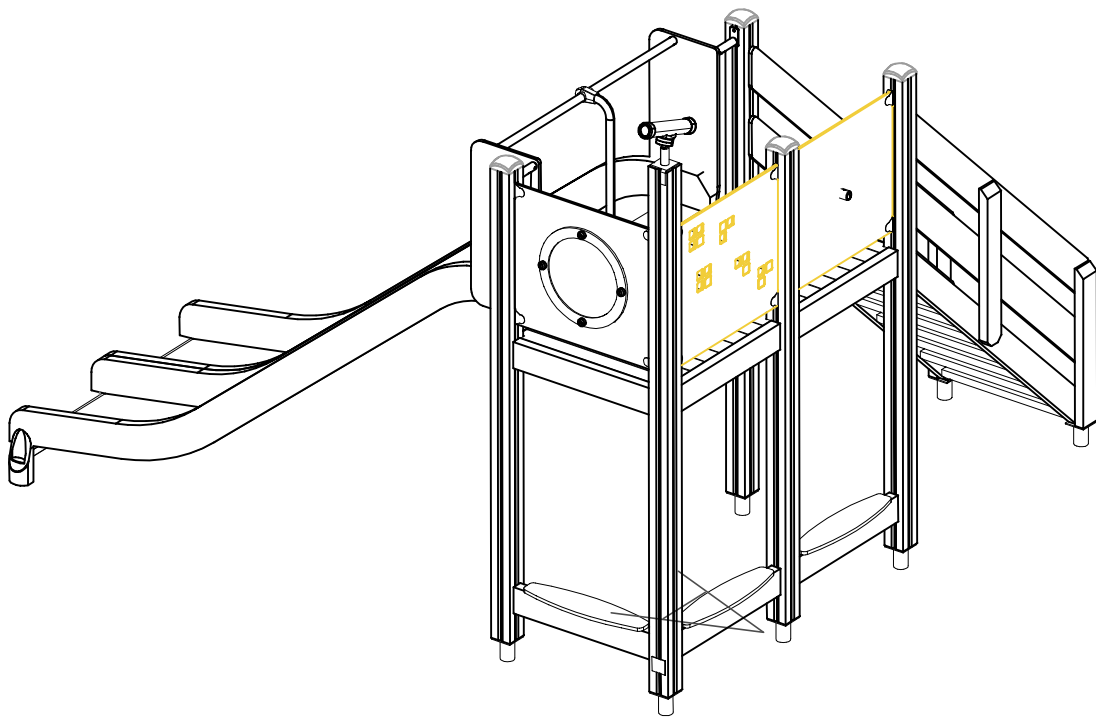

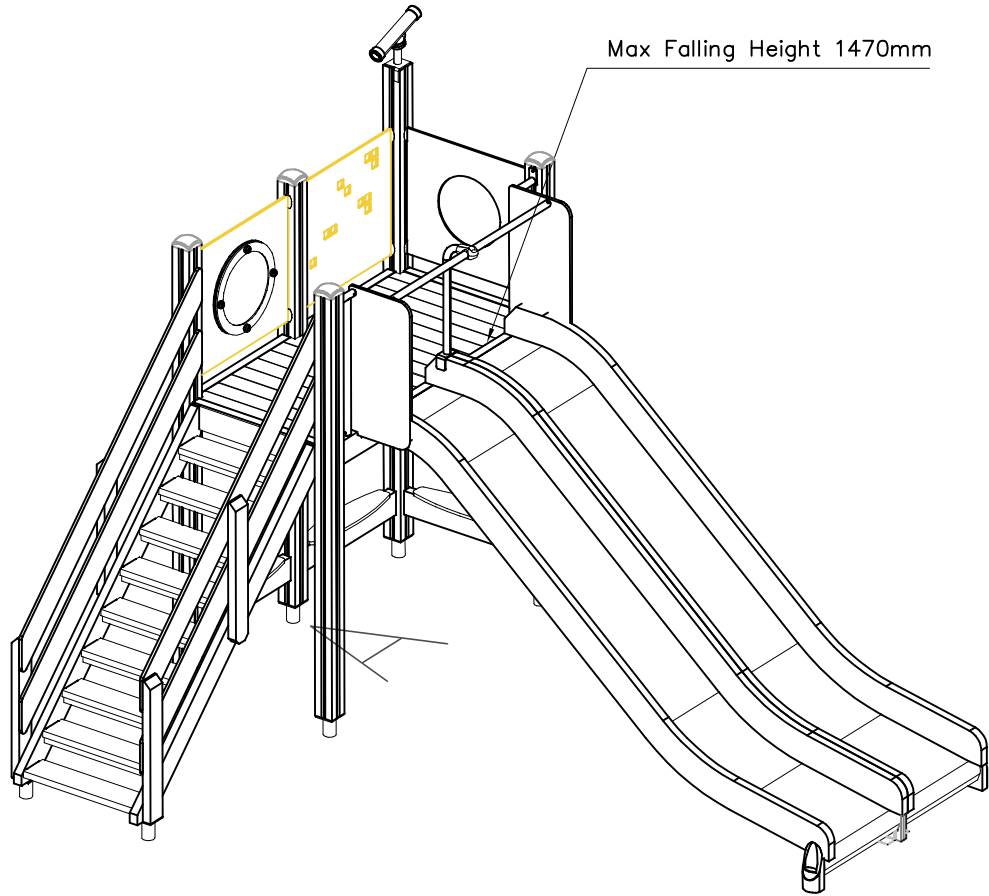

- EN/AS Impact Area 29.4 m²
- - - Falling Space 31.7 m²
Max Falling Height 1470 mm

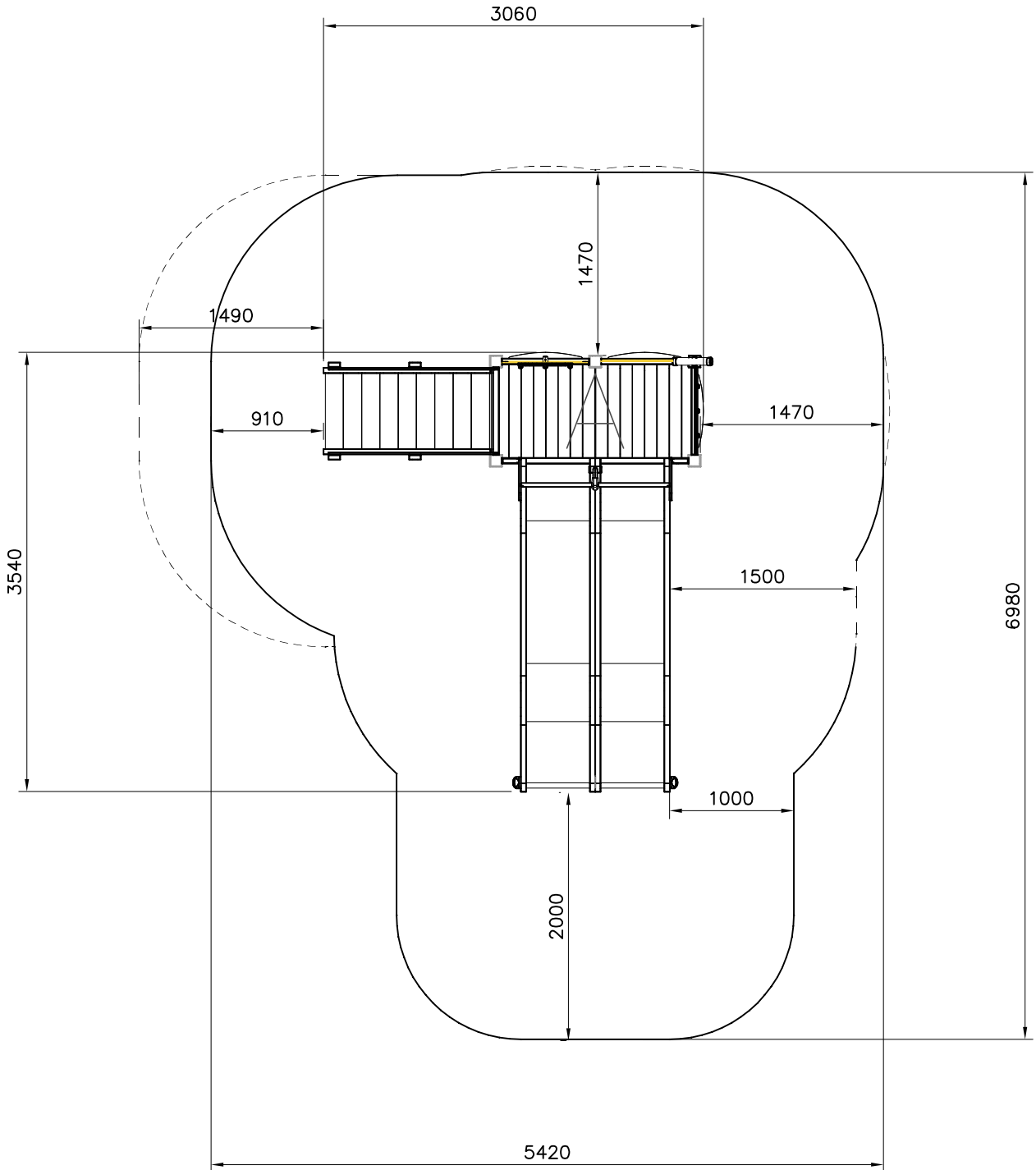
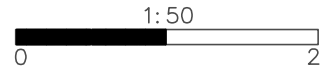
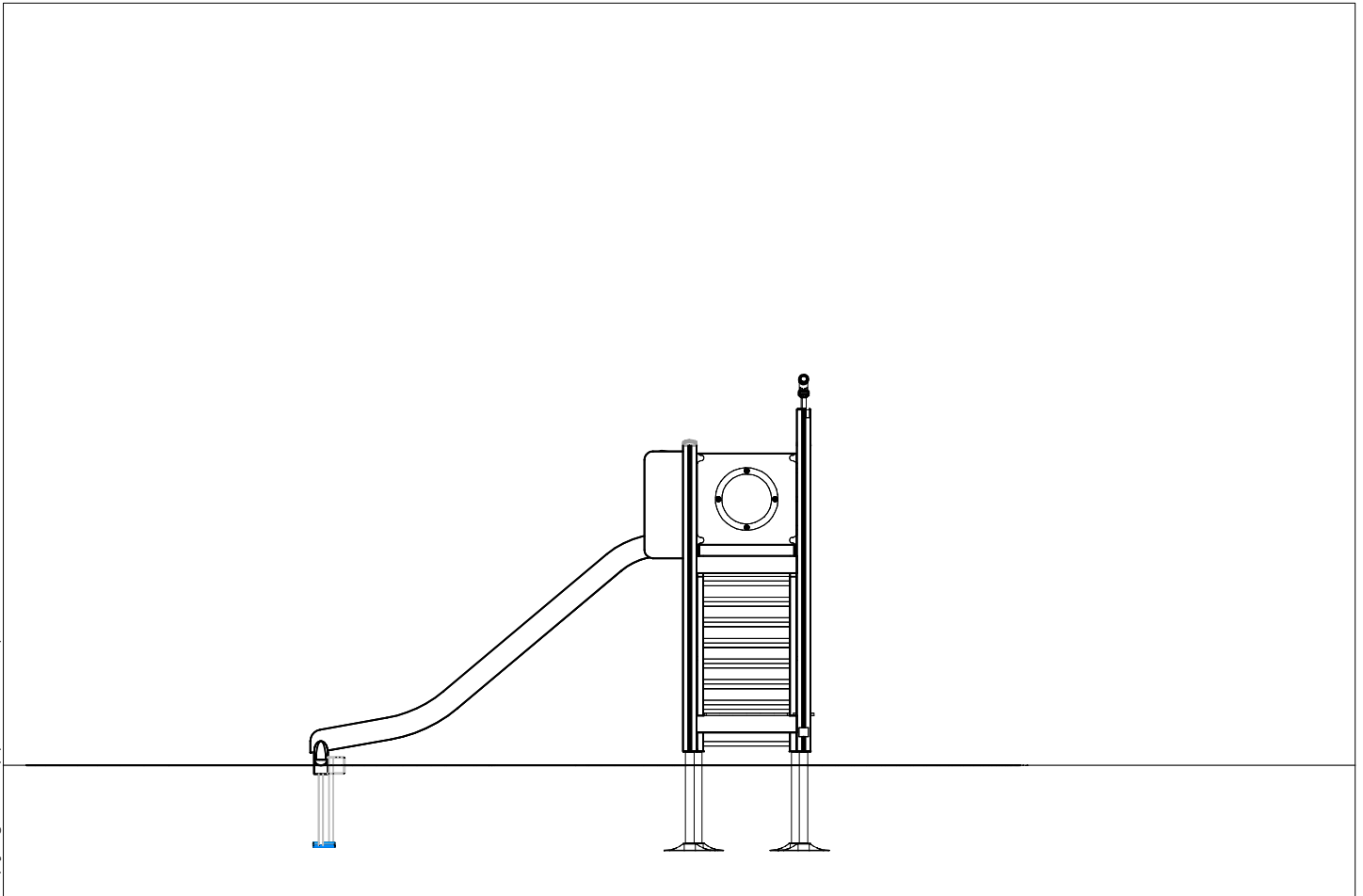
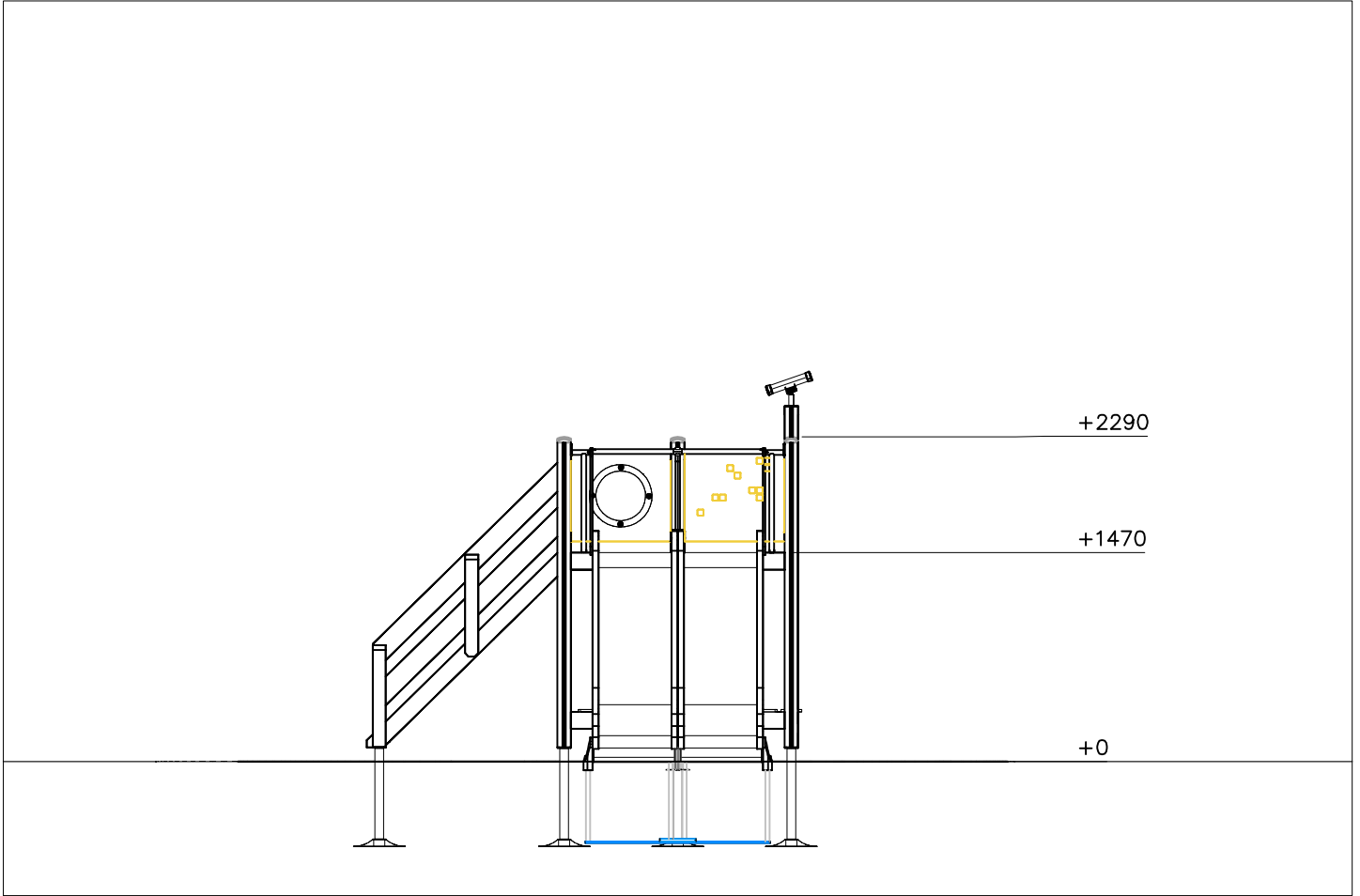

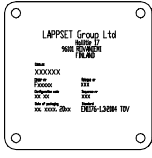
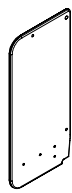
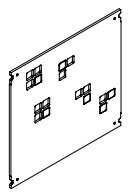
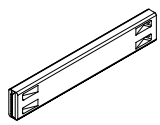
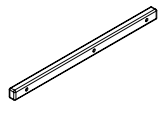
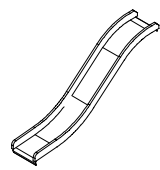
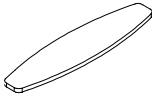
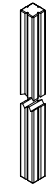
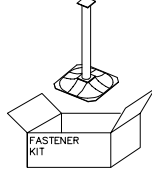
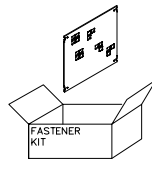
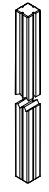
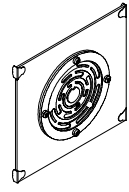
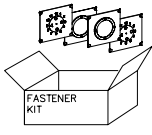

DATE: 23.8.2024

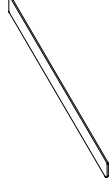
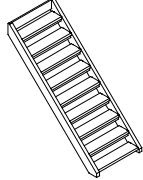
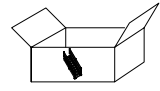
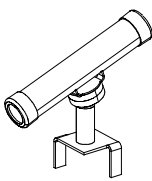
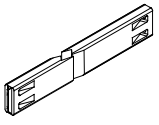
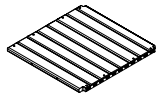
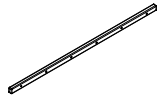
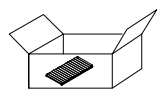
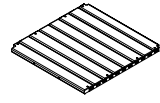
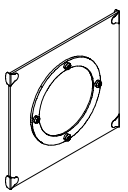
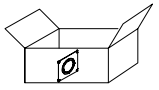
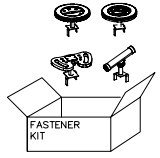
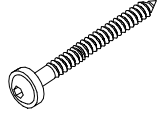
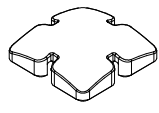
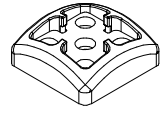
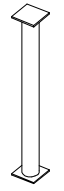
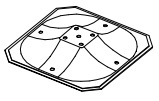
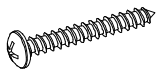
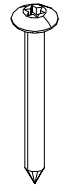
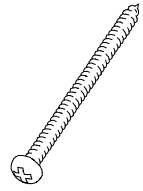
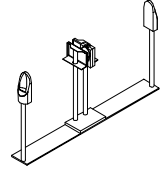
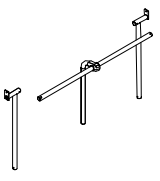
702286  65x65	PCS 1	706371-702  15x345x750	PCS 2	706436-702  10x640x702	PCS 1	706439-602  L 704	PCS 7	706443  32x45x702	PCS 2	706450-602  600x1381x2685	PCS 2
706453  15x145x600	PCS 3	706484-602  93x93x2150	PCS 4	706531  FASTENER KIT	PCS 7	706534  FASTENER KIT	PCS 1	706669-602  93x93x2400	PCS 1	706766-702  600x1381x2685	PCS 1
706778  FASTENER KIT	PCS 1	707145-602  43x93x717	PCS 2	707149-602  43x93x717	PCS 2	707152-702  15x145x2009	PCS 4	707192-602  +1470	PCS 1	707226  FASTENER KIT	PCS 1
707304  L 1504	PCS 1	707374-602  L 1504	PCS 1	707436  750x770	PCS 1	707437  32x45x1502	PCS 1	707440  750x770	PCS 1	707441  750x770	PCS 1
707453-702  10x640x702	PCS 1	707454  FASTENER KIT	PCS 1	707585  FASTENER KIT	PCS 1	903093  Ø8x90	PCS 32	905138  GRAY	PCS 4	905196  GRAY	PCS 4
909511  90x90x650	PCS 7	909519  50x380x380	PCS 7	980114  Ø4x20	PCS 4	980123  Ø7x60	PCS 12	980131  Ø6x60	PCS 16	A10874  FASTENER KIT	PCS 1
A10875-299  FASTENER KIT	PCS 1		PCS		PCS		PCS		PCS		PCS