

# **LAPPSET®**

## **FITNESS**







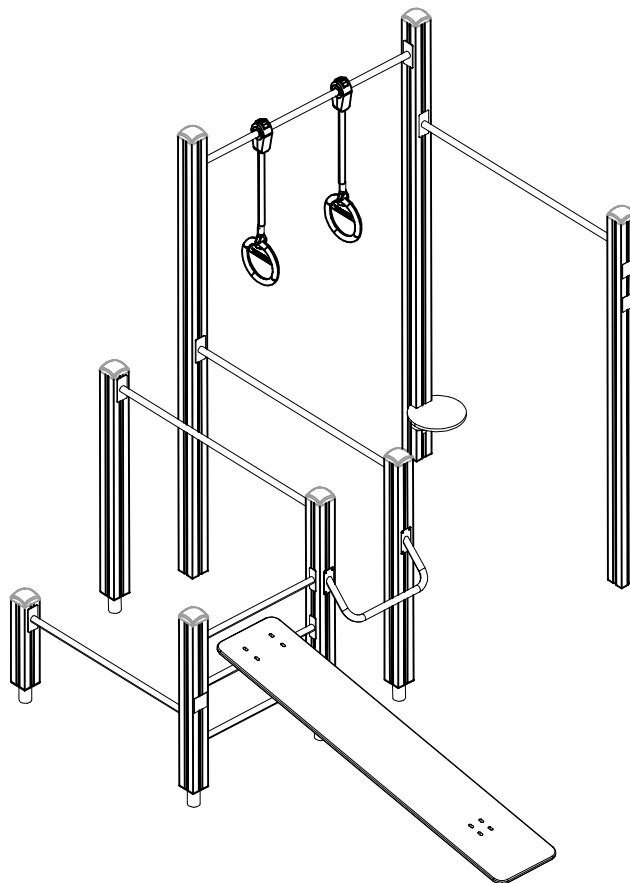





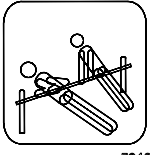
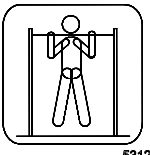

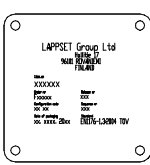
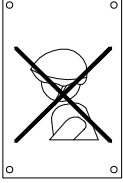
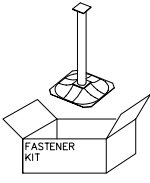

ASENNUSOHJE  
MONTERINGSANSVISNING  
INSTALLATION INSTRUCTION  
AUFBAUANLEITUNG  
NOTICE D'INSTALLATION

DATE: 1.8.2024

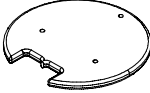
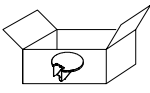
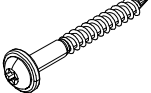
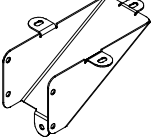
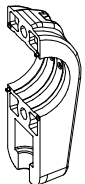
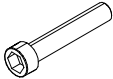
### **Q15435-4**

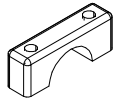
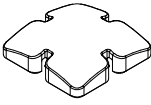
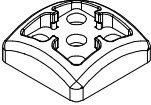
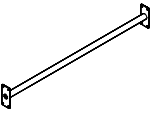
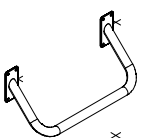
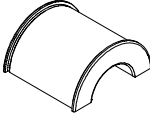
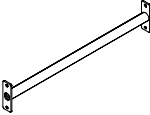
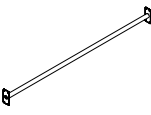
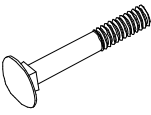
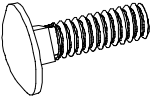
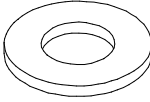
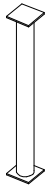
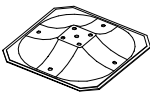
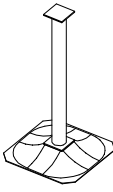
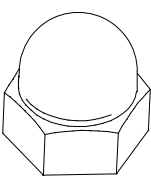
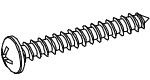

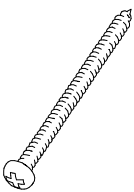
DATE: 1.8.2024

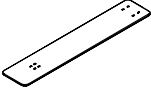
005301	PCS 1	005304	PCS 1	005310	PCS 1	005312	PCS 1	005321	PCS 1	005322	PCS 1
											
5301		5304		5310		5312		5321		5322	
701401-602	PCS 3	702286	PCS 1	702339	PCS 1	706531	PCS 5	706568-602	PCS 2	706662-602	PCS 1
											
L 1250		65x65		118x78		FASTENER KIT		93x93x3000		93x93x2600	
706894-602	PCS 1	707331-602	PCS 1	707696-704	PCS 1	707729	PCS 1	900240	PCS 20	902086	PCS 1
											
L 950		93x93x470		15x265x275				Ø8x70		148x172x254	
902195	PCS 4	902232	PCS 2	902233	PCS 2	902454	PCS 2	905138	PCS 8	905196	PCS 8
											
150x50x50		M10x55		M10x30				GRAY		GRAY	
905838-215	PCS 1	905934-215	PCS 1	906006	PCS 4	907694-215	PCS 3	908017-215	PCS 4	909107	PCS 4
											
L 1060				Ø64/36,4x59		L 704		L1315		M12x80	
909109	PCS 4	909256	PCS 40	909511	PCS 5	909519	PCS 8	909521	PCS 1	909644	PCS 8
											
M12x40		Ø16/8.4		90x90x650		50x380x380				M12	
980114	PCS 8	980123	PCS 40	980131	PCS 32	980154	PCS 32	980161	PCS 4	P01987	PCS 1
											
Ø4x20		Ø7x60		Ø6x60		Ø24/13		M10		2000x380	

P10375  Ø16x764	PCS		PCS		PCS		PCS		PCS		PCS
	2										
	PCS		PCS		PCS		PCS		PCS		PCS
	PCS		PCS		PCS		PCS		PCS		PCS
	PCS		PCS		PCS		PCS		PCS		PCS
	PCS		PCS		PCS		PCS		PCS		PCS

— EN/AS Impact Area 31.9 m<sup>2</sup>

- - - Falling Space 33 m<sup>2</sup>  
Grid size = 1000mm

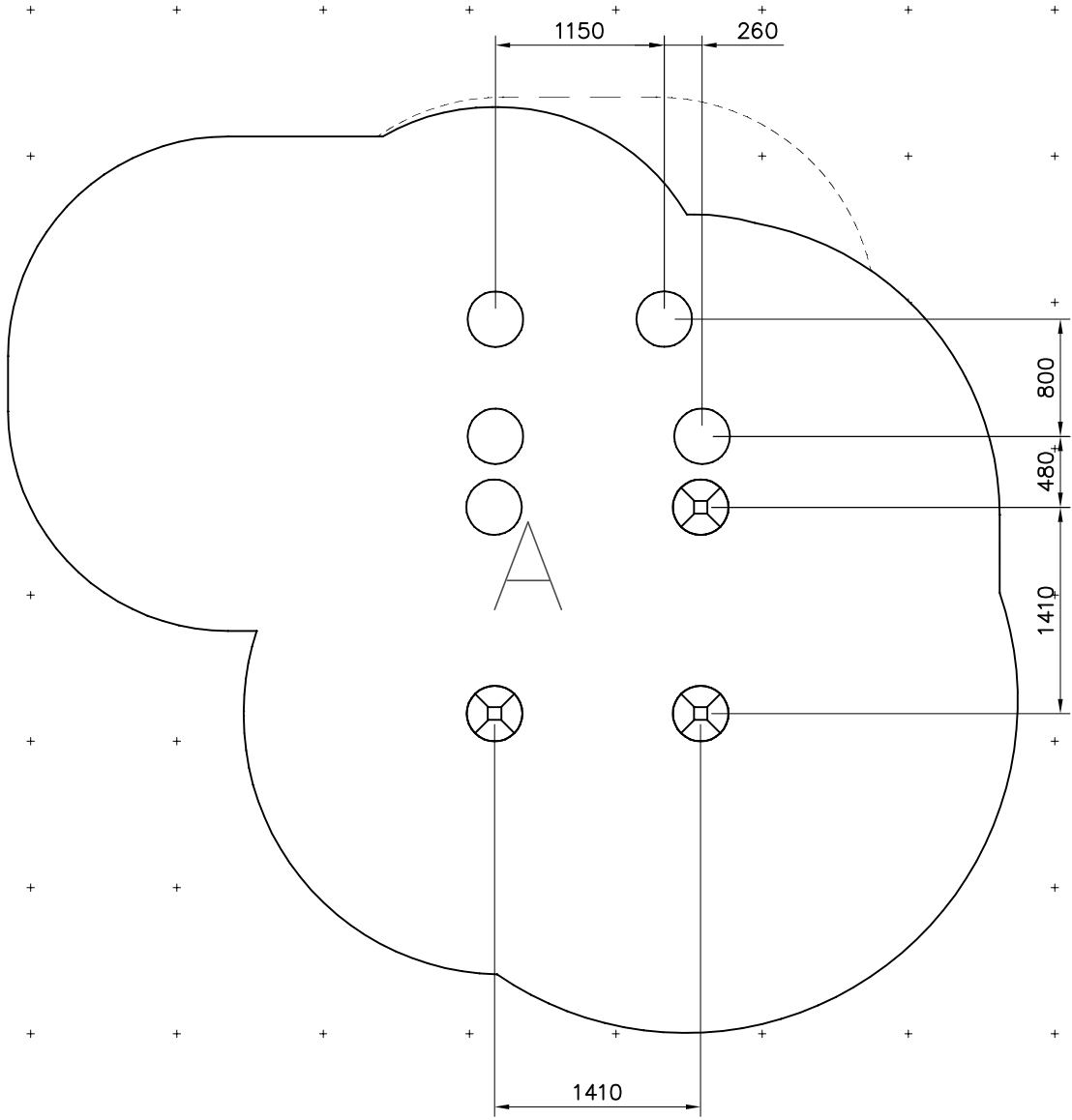
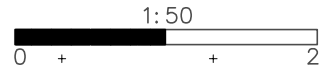

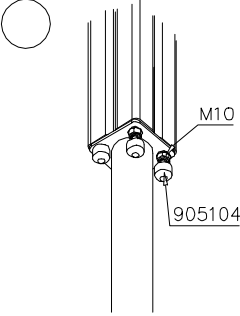
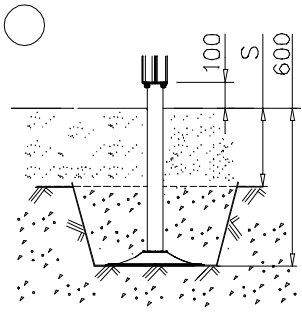
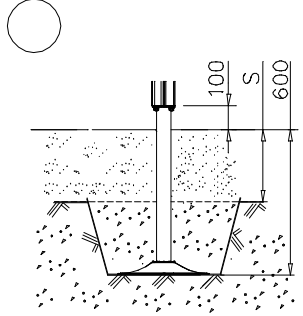
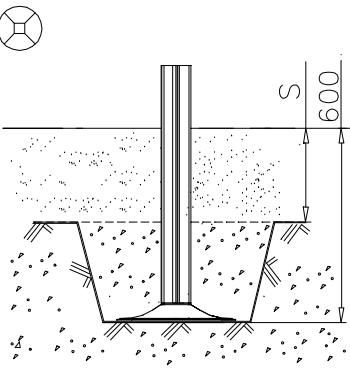
- EN/AS Impact Area 31.9 m<sup>2</sup>
- - - - Falling Space 33 m<sup>2</sup>
- + + + Training Space 11.3 m<sup>2</sup>
- Max Falling Height 2290 mm



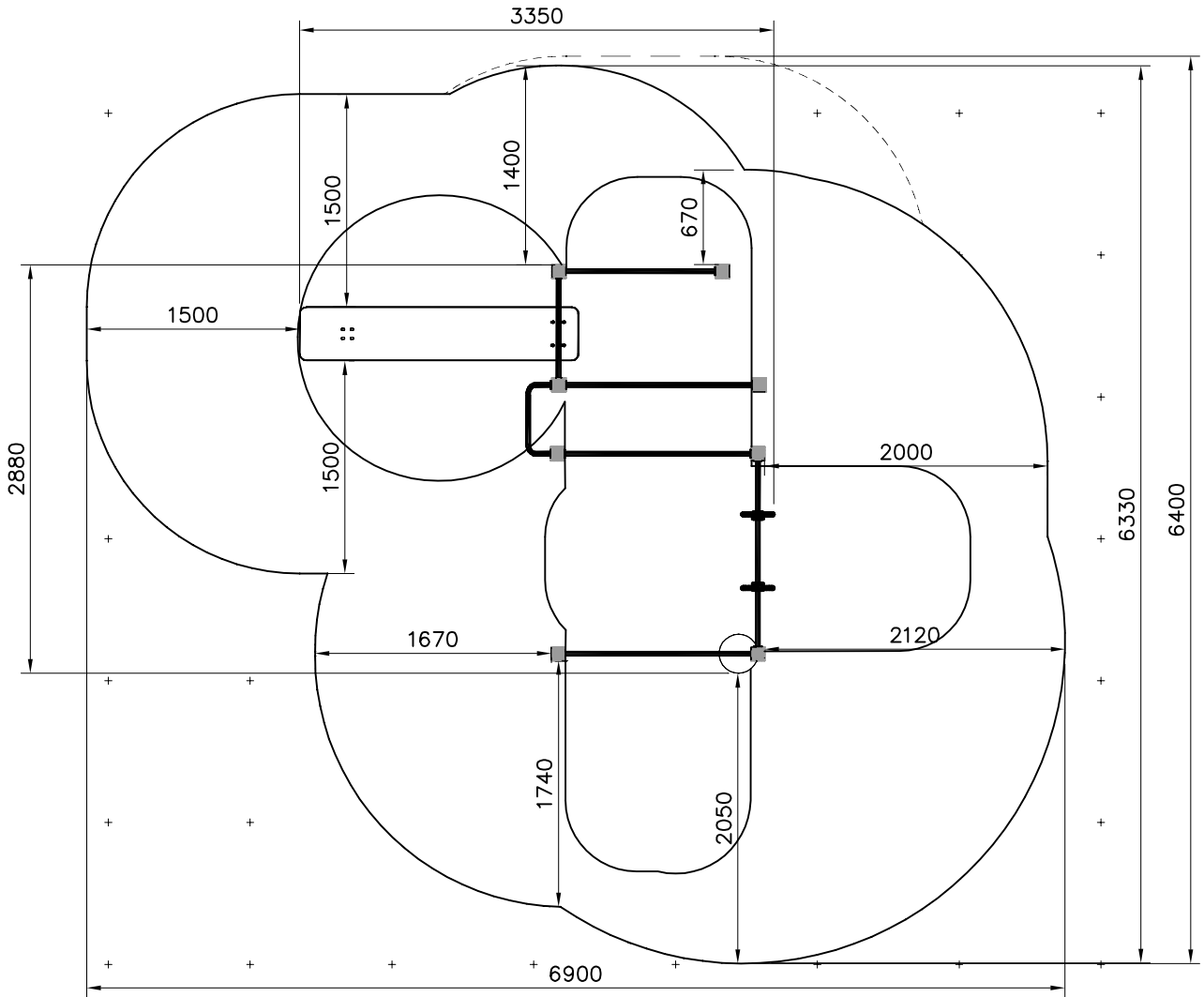
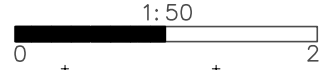

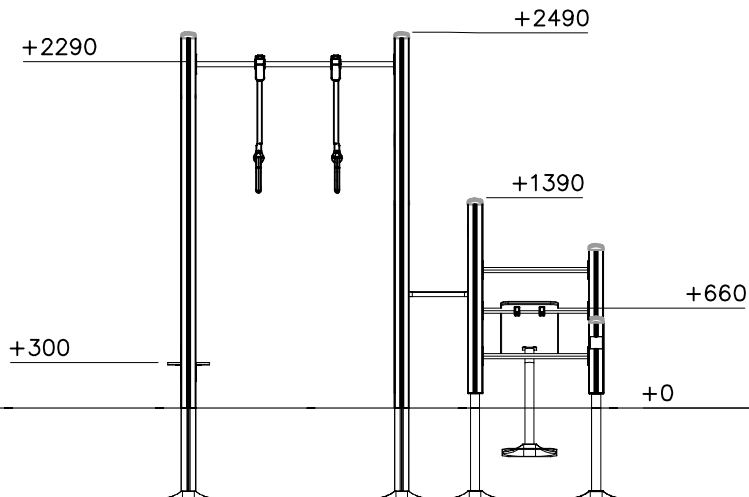
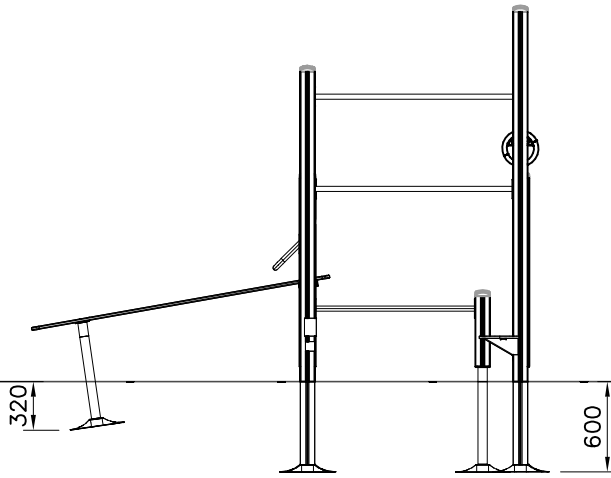

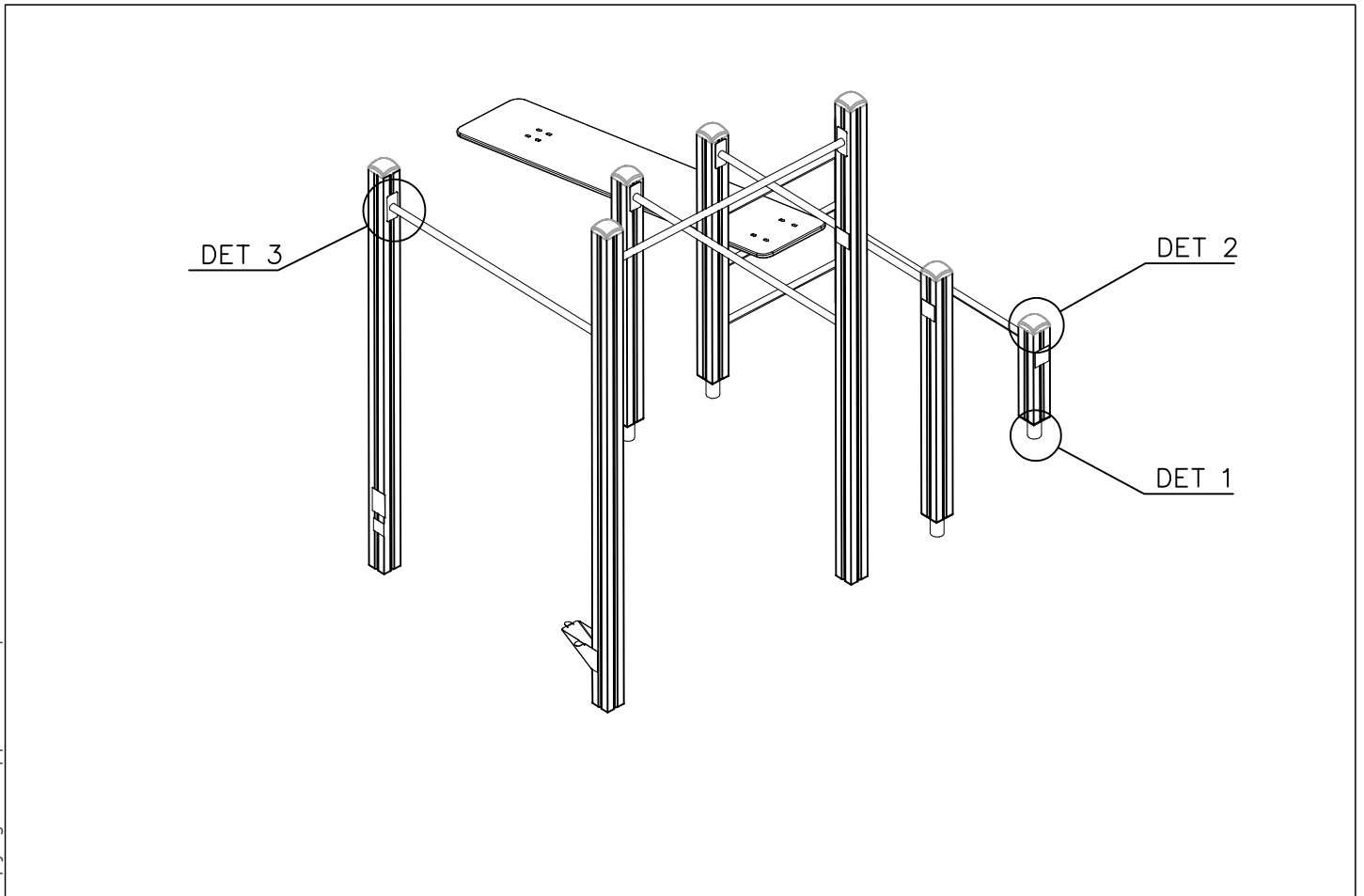
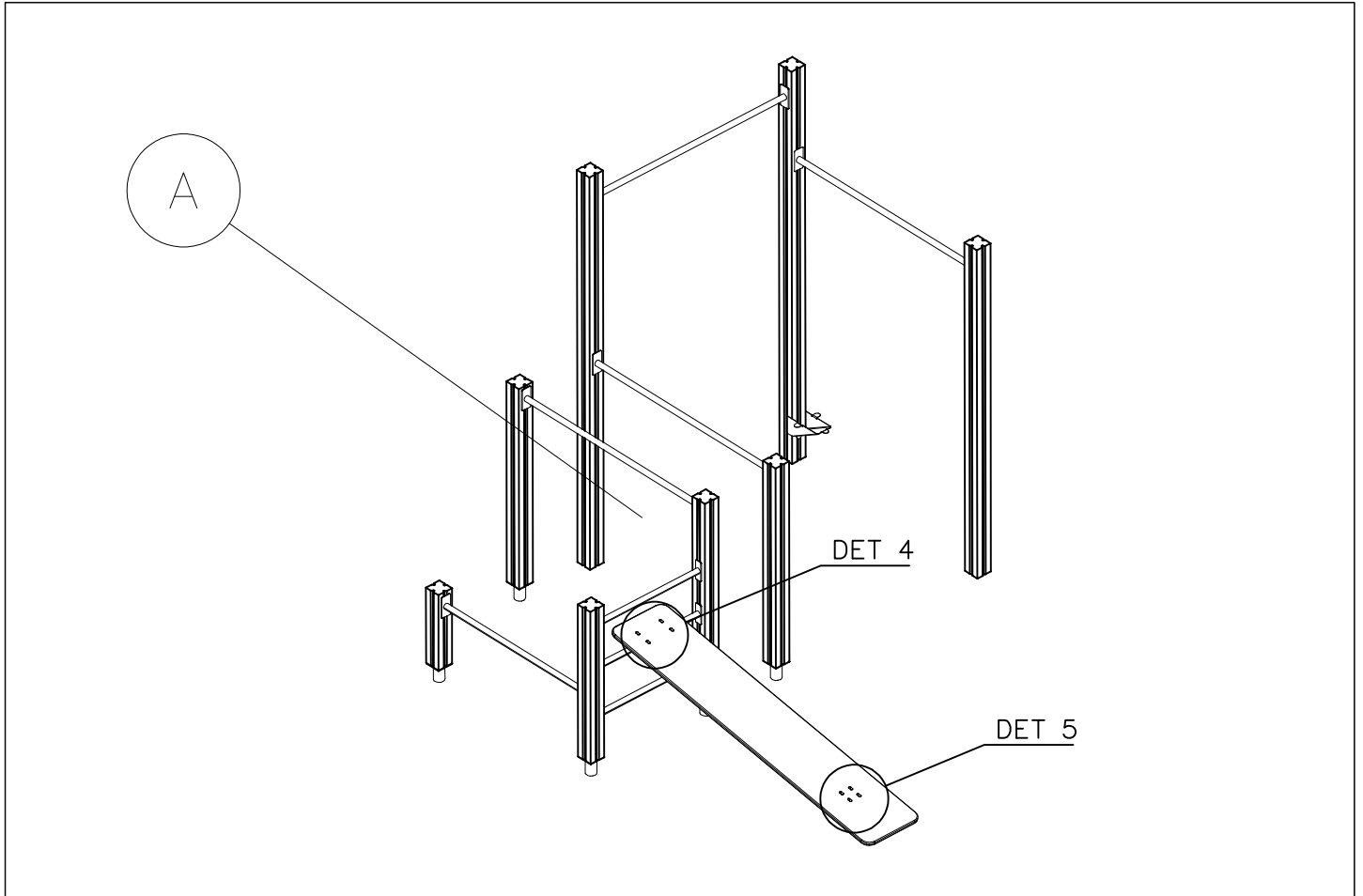

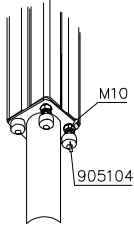
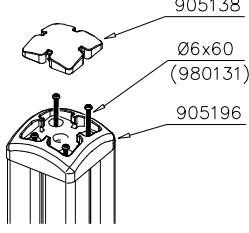
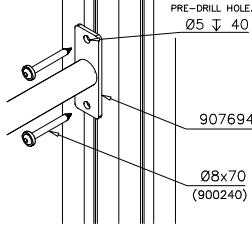
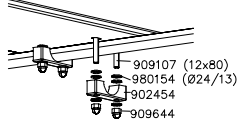
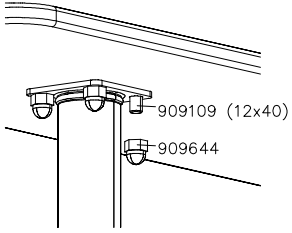
<p>DET 1</p> 	<p>DET 2</p> 	<p>DET 3</p> 	<p>DET 4</p> 
<p>DET 5</p> 			

DATE: 1.8.2024

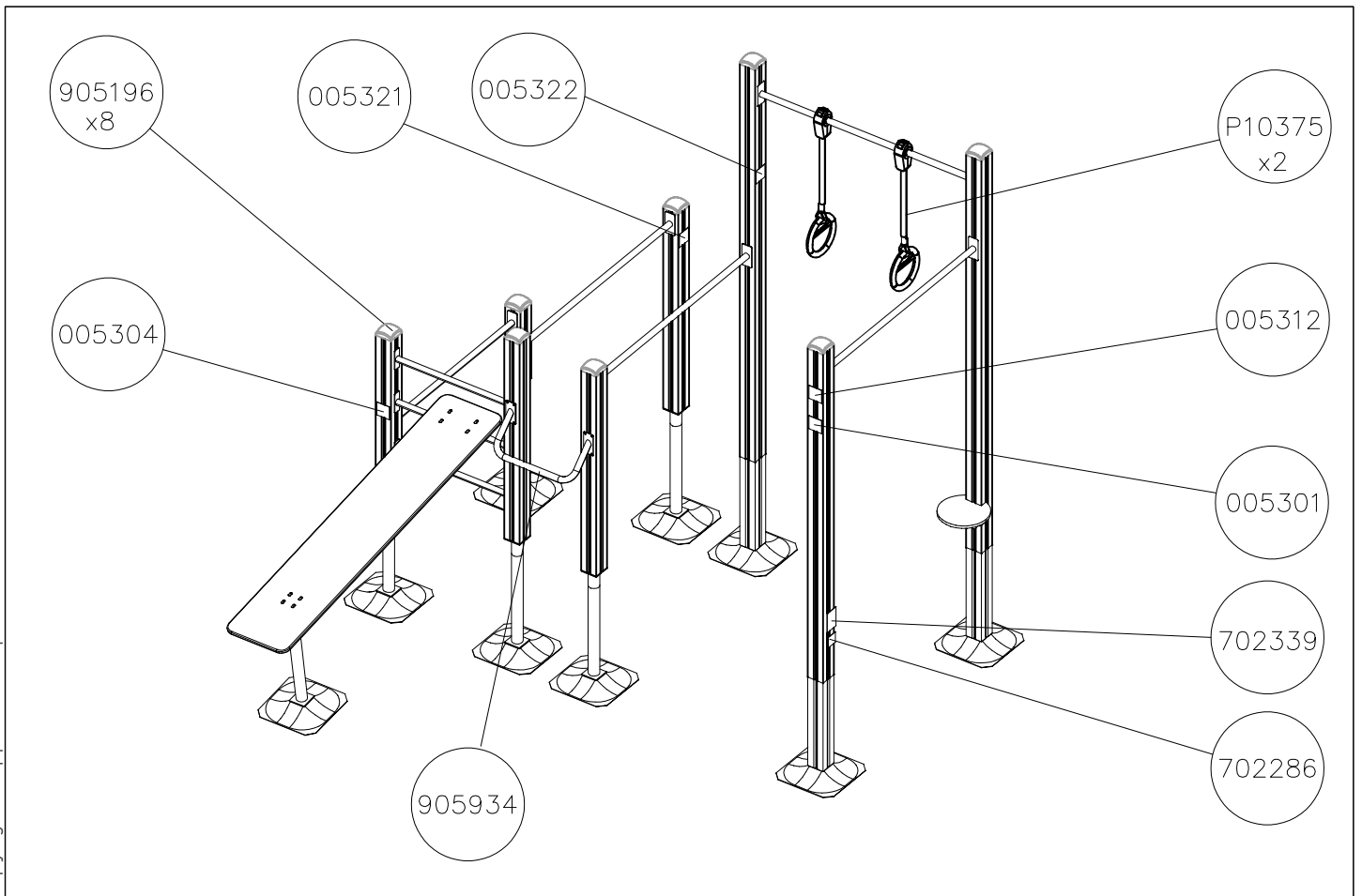
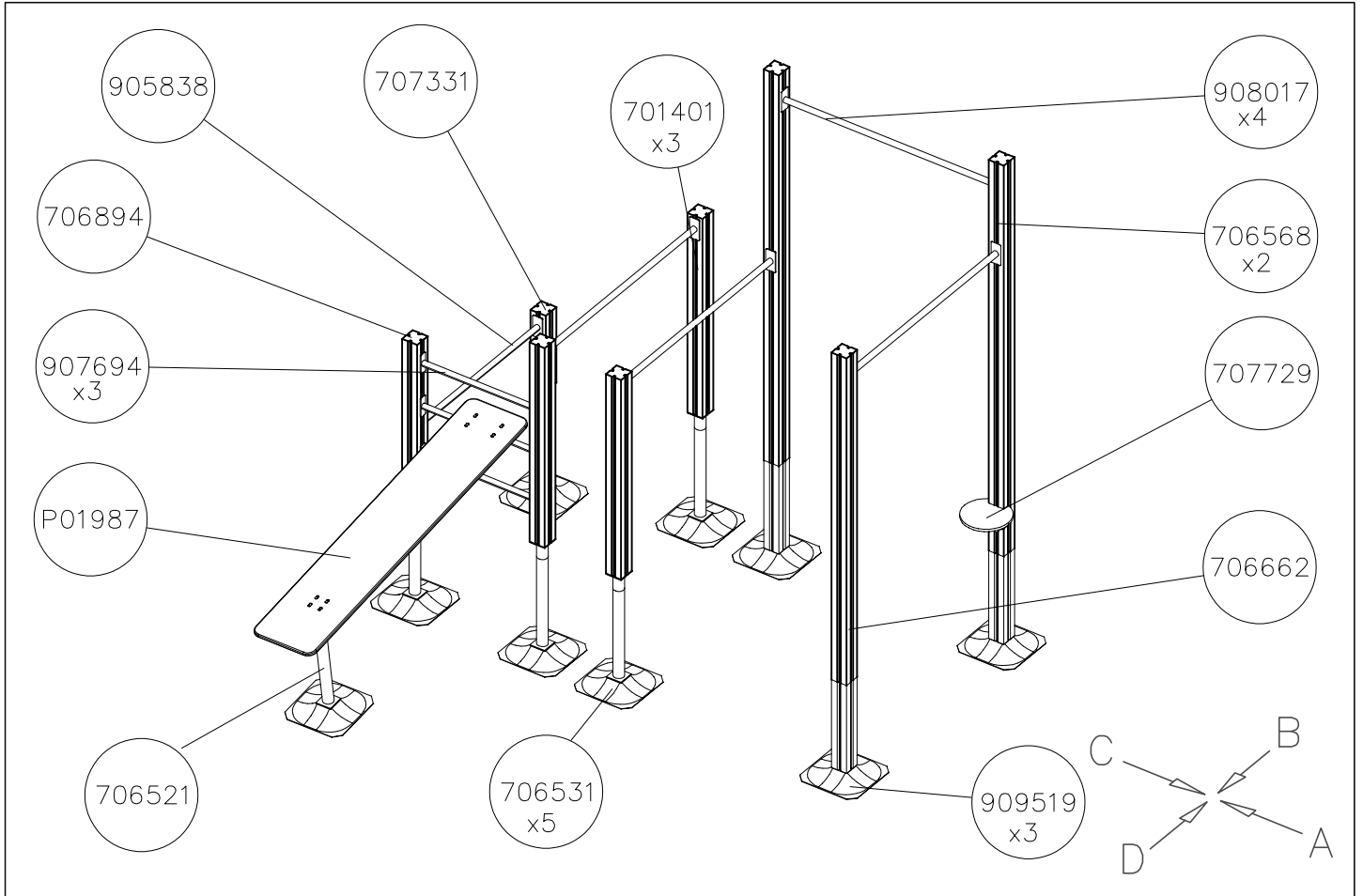

DATE: 1.8.2024

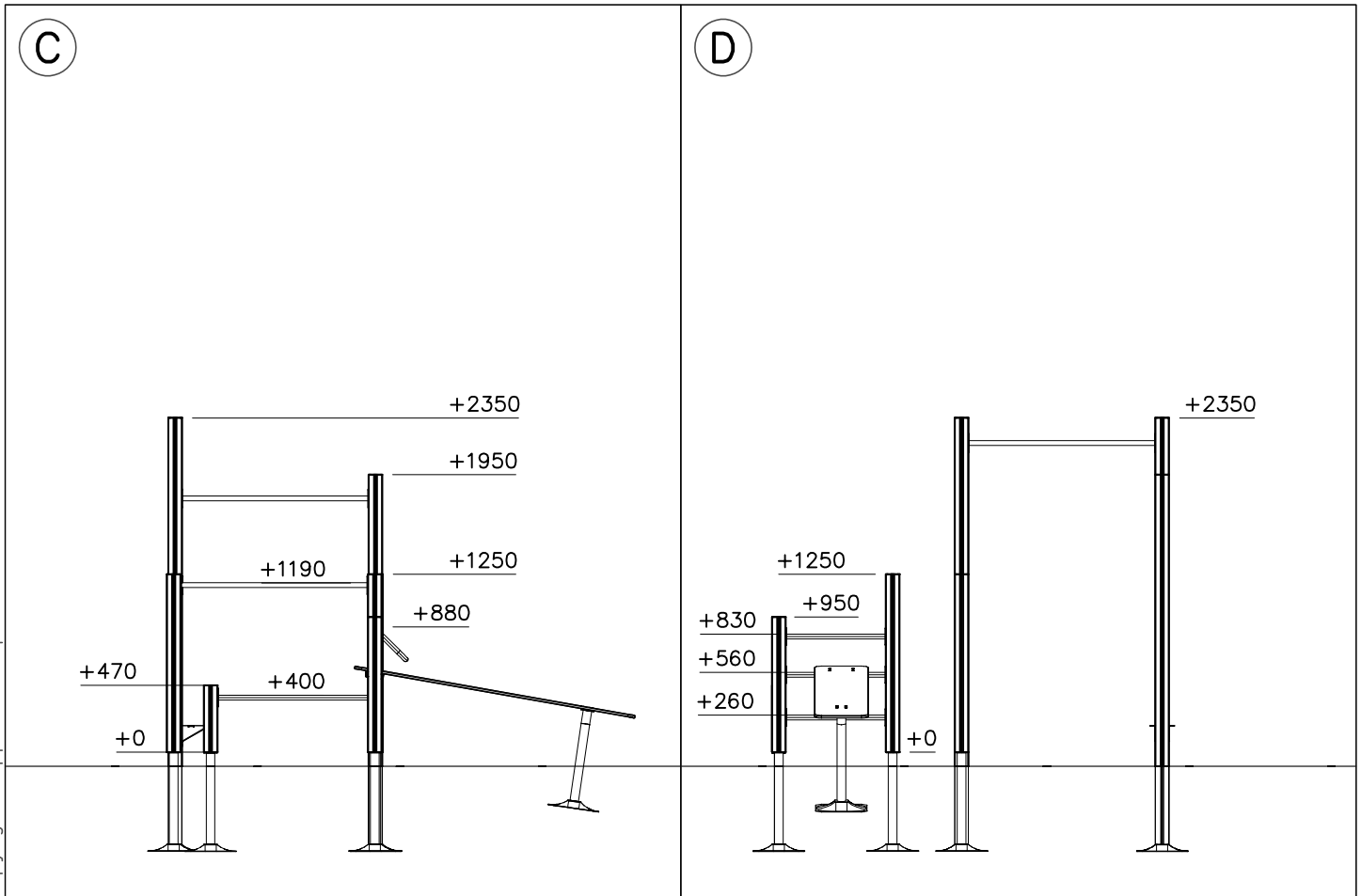
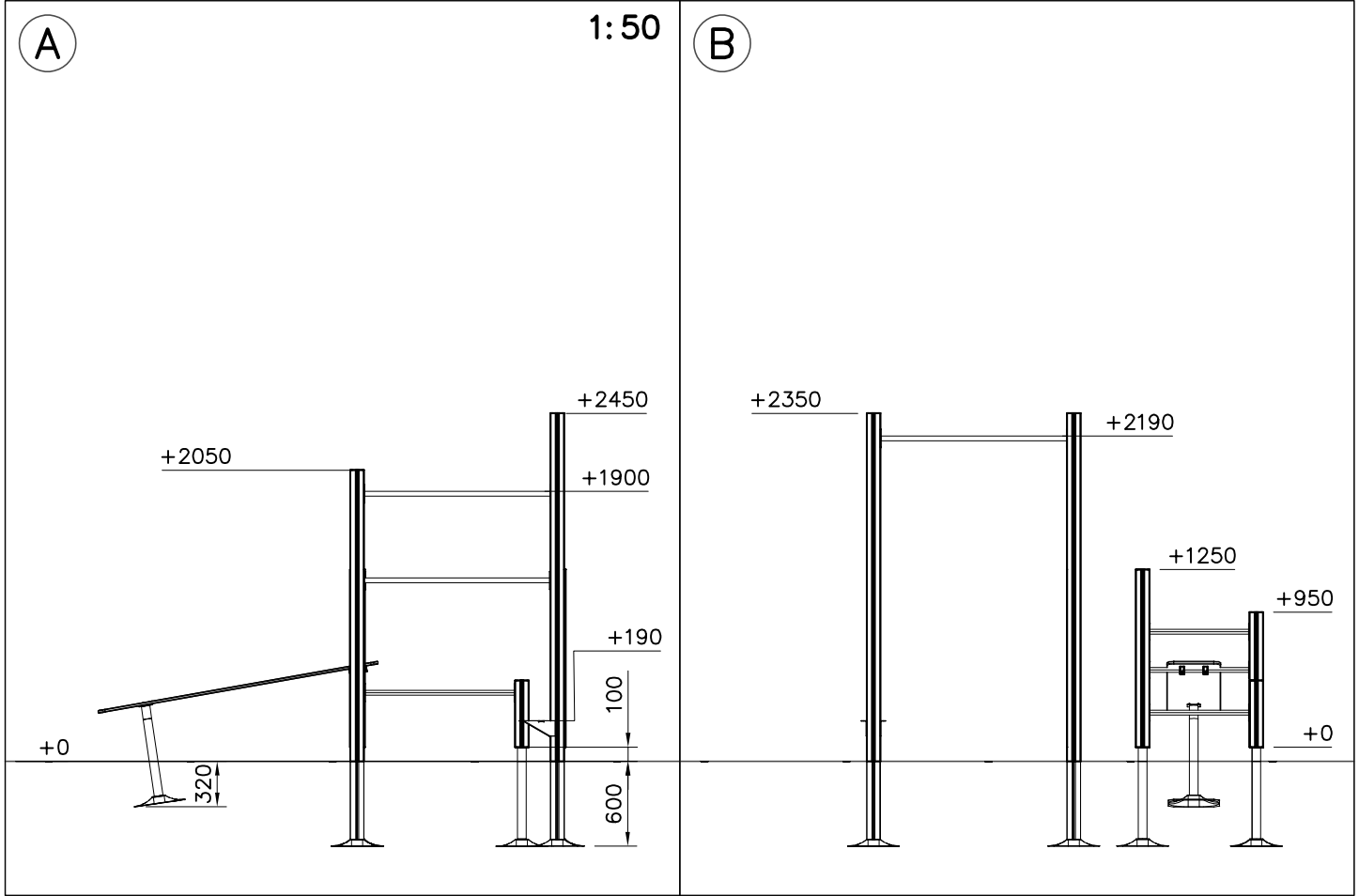

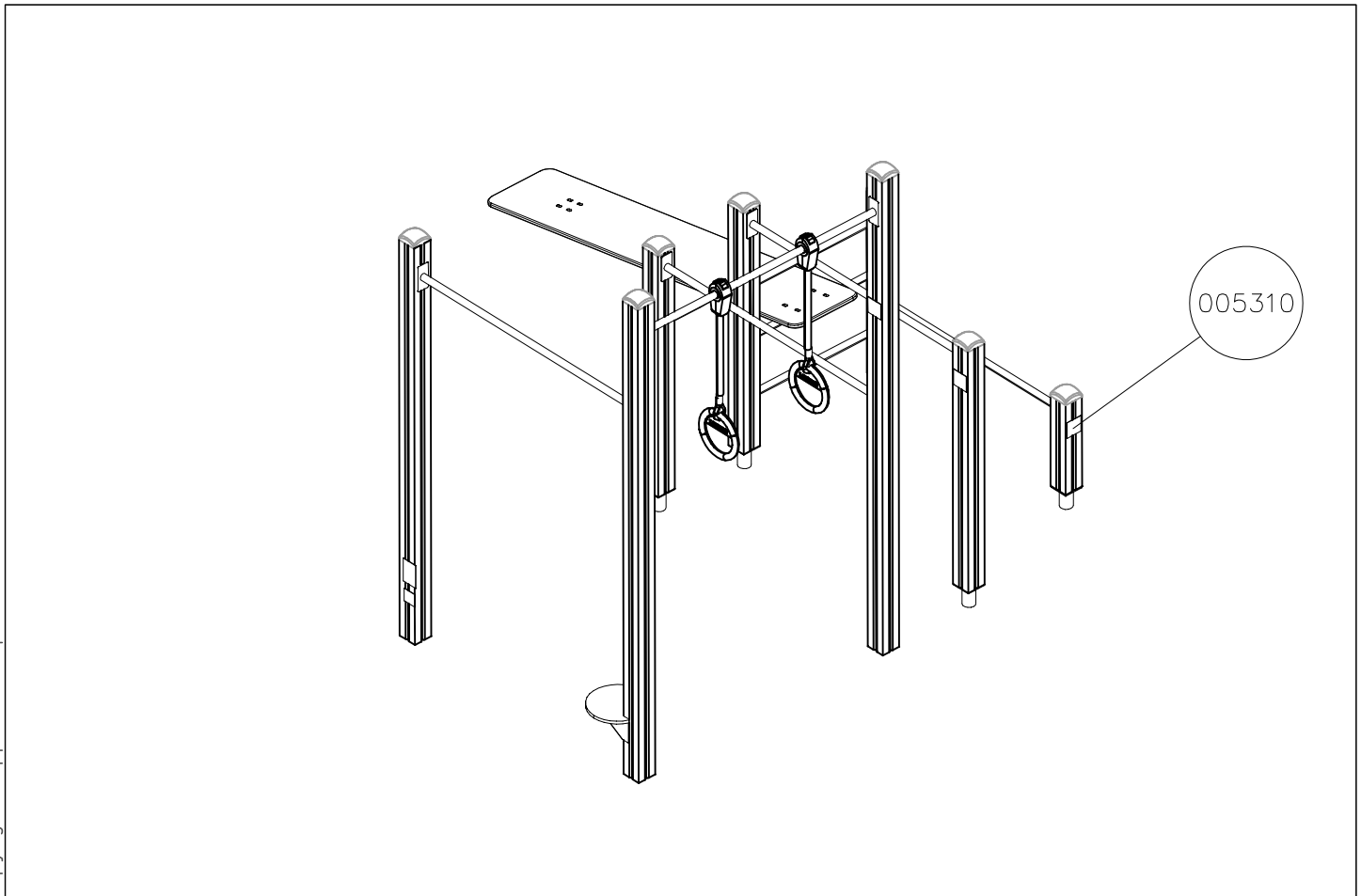
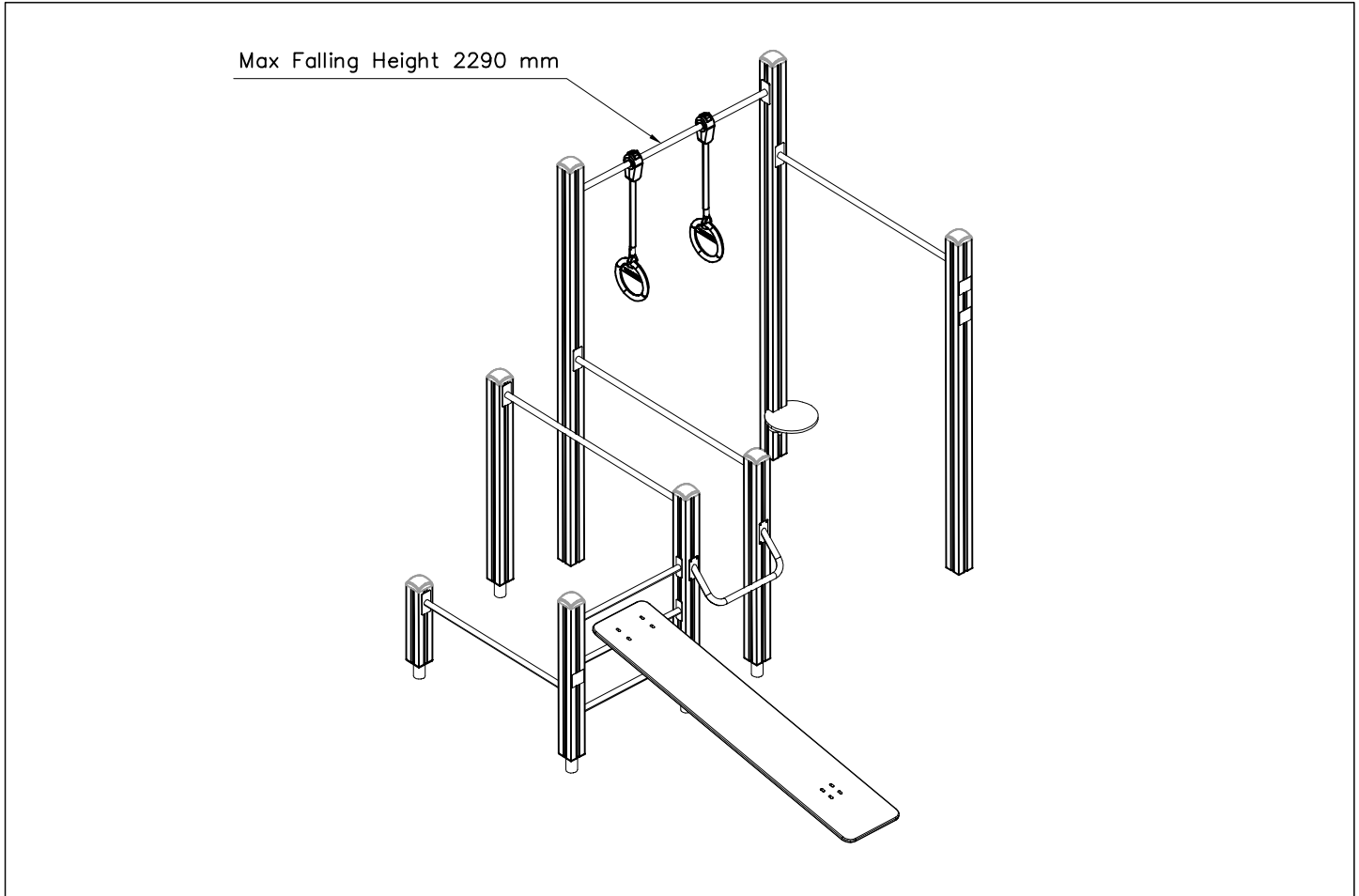

# LAPPSET® DEEP FOUNDATION

# FOOT

DATE: 15.5.2018

1(1)



①	909511	PCS	②	909519	PCS
		1			1
	90x90x650			50x380x380	



③	909637	PCS	④	909638	PCS
		4			8
	M10			Ø20/10.5	

⑤	909639	PCS	⑥	905104	PCS
		4			4
	M10x25			M10	



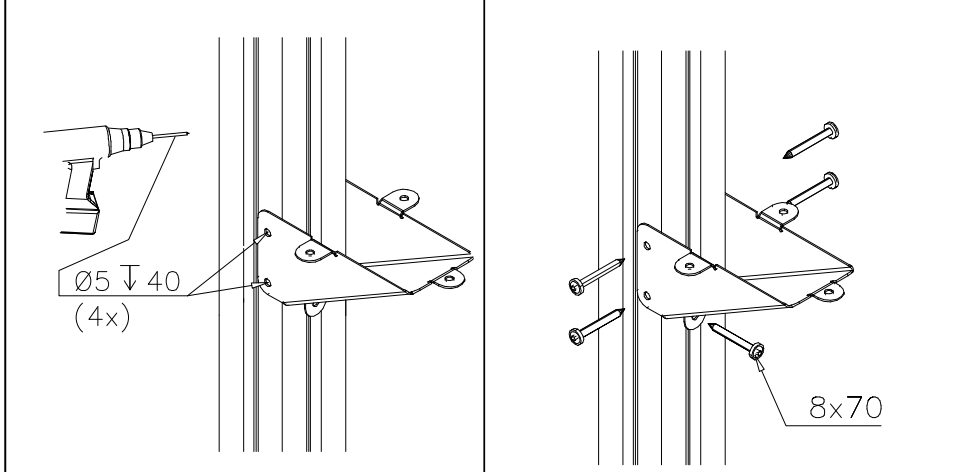
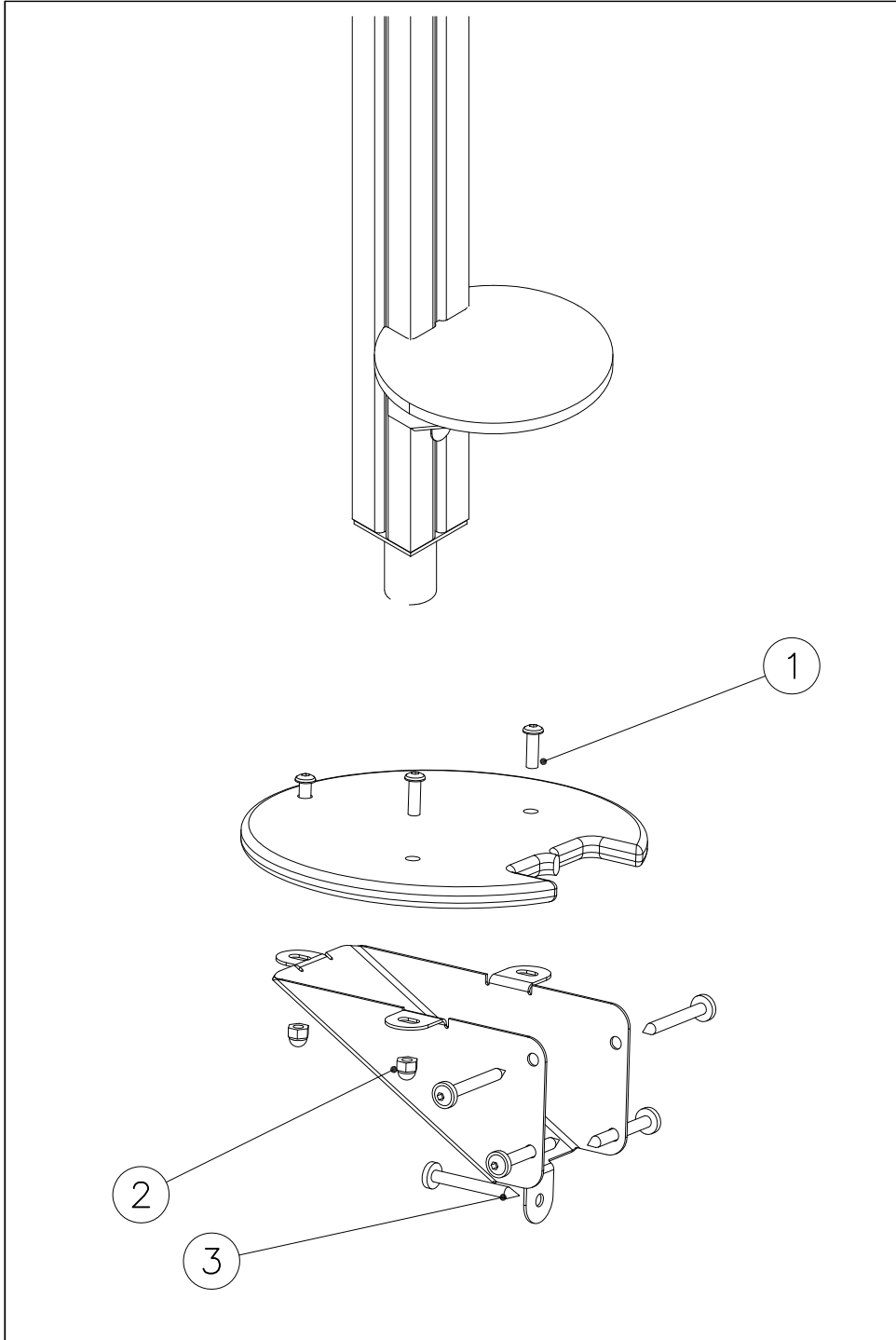

OPTION FOOT

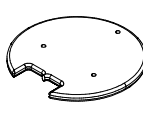
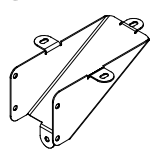
①	911155	PCS			PCS
		1			
	90x90x650				

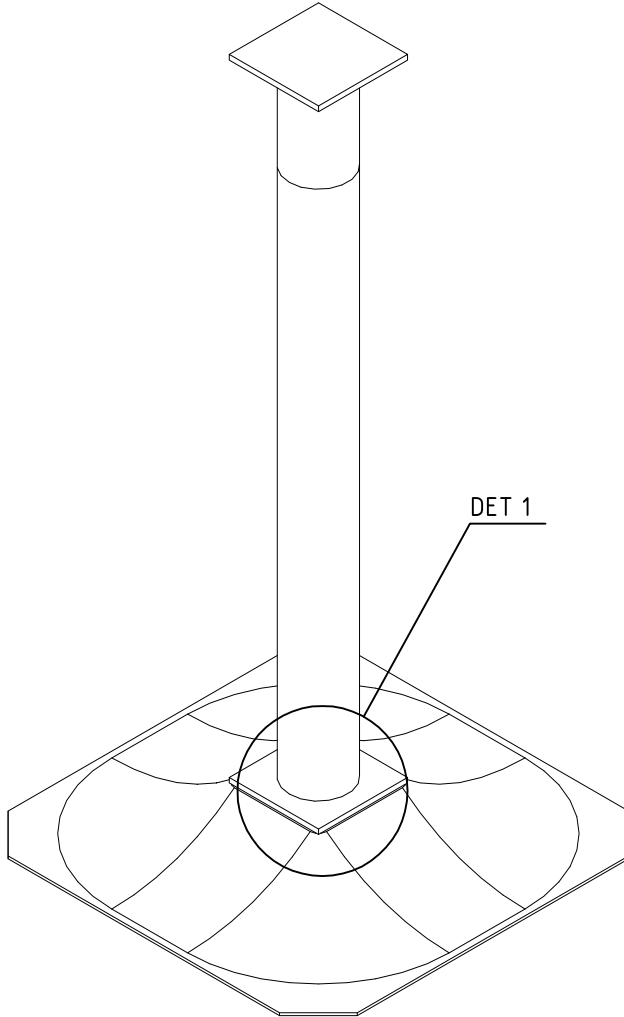

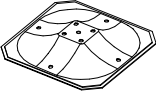
①	909850	PCS	②	909633	PCS
		3			3
	M8x25			M8	
③	900240	PCS			PCS
		5			
	Ø8x70				
		PCS			PCS
○	707696	PCS	○	902086	PCS
		1			1
	15x265x275			148x172x254	
		PCS			PCS
		PCS			PCS
		PCS			PCS
		PCS			PCS



①	909511	PCS	②	909519	PCS
		1			1
③	909637	PCS	④	909638	PCS
		4			8
	M10			Ø20/10.5	
⑤	909639	PCS			PCS
		4			
	M10x25				
		PCS			PCS
		PCS			PCS
		PCS			PCS
		PCS			PCS
		PCS			PCS

DET 1

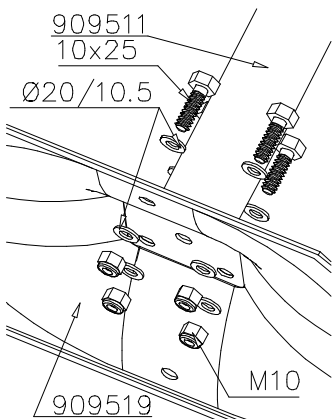





**LAPPSET®**  
**BETON FOUNDATION**

**FOOT**

DATE: 27.10.2015

**1(1)**

② 905104	PCS		PCS
	4		
 M10	PCS		PCS



905104

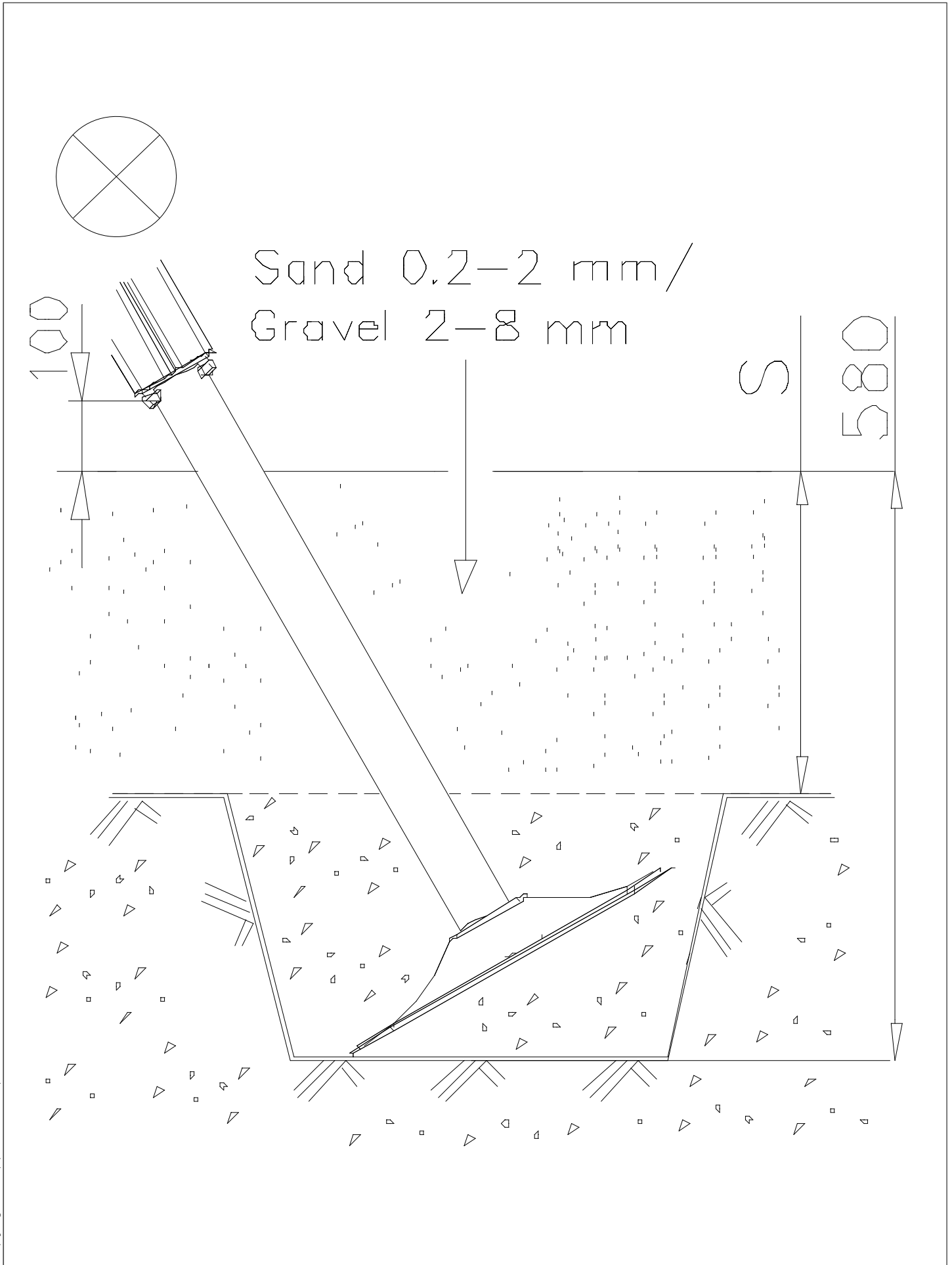



## Tuotekyltti tulee tuotteen mukana yhdellä seuraavista tavoista:

### 1) Metallinen tuotekyltti ja kiinnitysruuvit

- Kiinnitä tuotekyltti ruuveilla tolppaan noin 2 metrin korkeuteen kuvan 1 mukaisesti.

### 2) Tuotekylttitarra

- Puhdista maalattu metalli- tai vaneripinta pölystä ja kosteudesta. Liimaa tarra kuvan 2 mukaisesti.
- Huom. Älä kiinnitä tarraa karheapintaiseen laminaattiin tai maalattuun puuhun.

## Vår produktmärkning levereras på ett av följande sätt:

### 1) Produktskylt i metall

- Fäst skylten med de medföljande skruvarna

### 2) Självhäftande produktetikett

- Rengör den pulverlackerade metallytan eller laminatyten så att den blir fri från smuts och fukt. Fäst etiketten enligt fig. 2.
- Obs! Fäst ej etiketten på detaljer med skrovlig yta eller på målat trä.

## Product label is delivered by one of following ways:

### 1) Metal product label and screws

- Fasten the label with screws.

### 2) Label sticker

- Clean the painted metal or plywood surface from dirt and moisture. Fasten the sticker as shown in the figure 2.
- Note. Do not attach the sticker to rough surfaced laminate or painted wood.

## La plaque d'informations produit est livrée sous l'une de ces 3 formes :

### 1) Plaque métallique et vis

- Fixez la plaque à l'aide des vis.

### 2) Etiquette autocollante

- Avant de coller l'étiquette, nettoyez le composant métallique peint ou la plaque de contreplaqué, de toute saleté. La surface doit être sèche (voir image 2).
- Attention, ne pas coller l'étiquette sur une surface lamellé-collée irrégulière ou sur du bois peint.

## Die Auslieferung des Produktaufklebers erfolgt auf eine dieser Arten:

### 1) Produkt-Schild aus Metall incl. Schrauben

- Die Befestigung des Schildes erfolgt mittels der Schrauben.

### 2) Aufkleber

- Entfernen Sie zunächst Schmutz und Feuchtigkeit vom lackierten Metall bzw. von der Holzoberfläche und bringen Sie den Aufkleber wie im Bild oben rechts beschrieben auf den gesäuberten Untergrund auf.
- Beachten Sie: Bringen Sie den Aufkleber nicht auf raues laminiertes oder lackiertes Holz an.