

LAPPSET®

PROMENADE





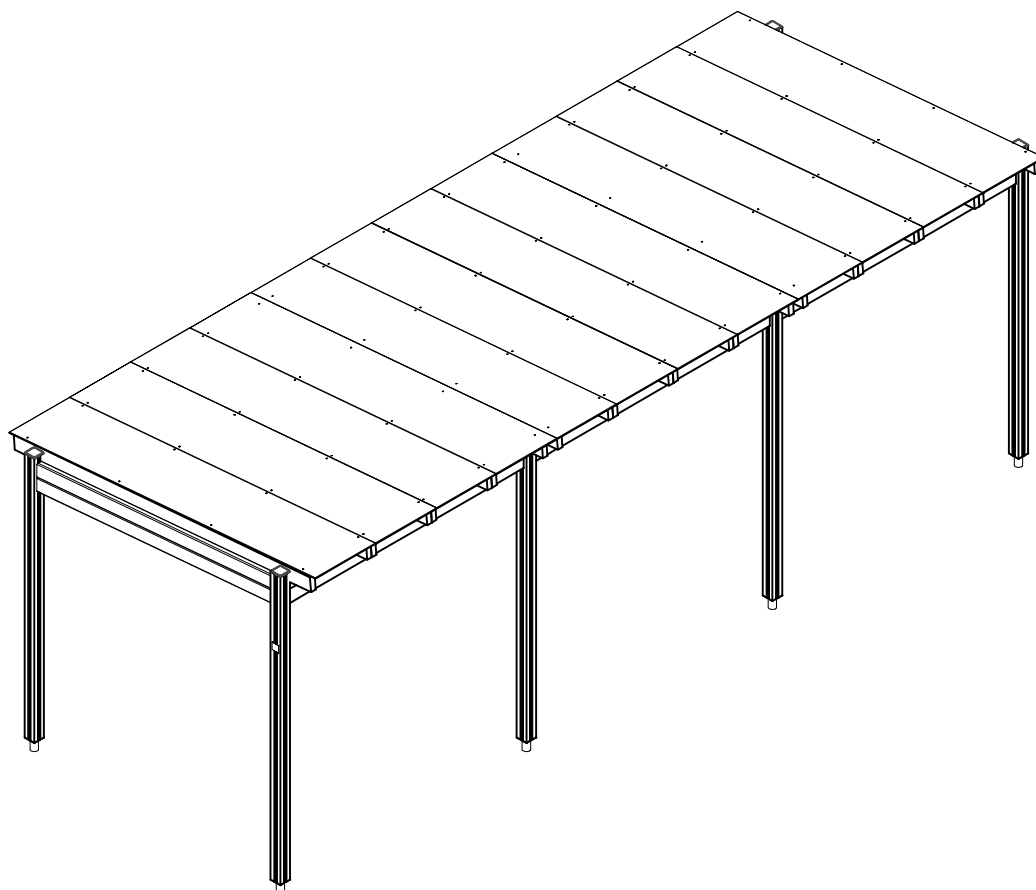

ASENNUSOHJE
MONTERINGSANSVISNING
INSTALLATION INSTRUCTION
AUFBAUANLEITUNG
NOTICE D'INSTALLATION

DATE: 21.8.2024

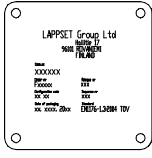
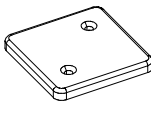
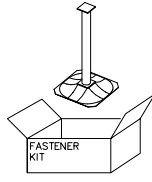
Q16139-2

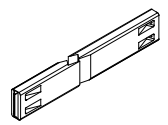
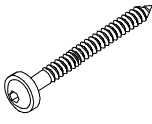
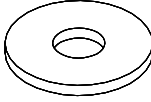
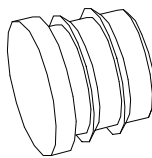

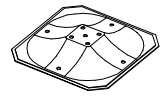
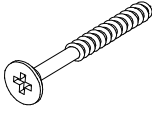
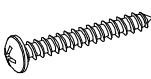
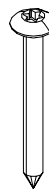
DATE: 21.8.2024

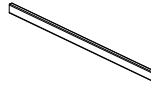
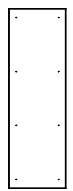
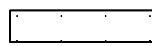
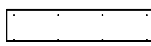
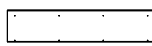
702286  65x65	PCS 1	706481-704  83x83x10	PCS 8	706531  FASTENER KIT	PCS 8	706662-602  93x93x2600	PCS 4	706669-602  93x93x2400	PCS 4	707295-602  L 2304	PCS 12
903093  Ø8x90	PCS 80	905051  Ø24/8.4	PCS 48	905066  S30H	PCS 48	909232  8x120	PCS 48	909511  90x90x650	PCS 8	909519  50x380x380	PCS 8
980107  Ø6x60	PCS 16	980114  Ø4x20	PCS 4	980128  Ø7x40	PCS 96	P10563-602  L 2900	PCS 24	P15316 	PCS 8	P15980-704  10x598x3000	PCS 7
P17751-704  10x598x3000	PCS 2	P17755-704  10x598x3000	PCS 2	P18021-704  10x643x3000	PCS 1		PCS		PCS		PCS
	PCS		PCS		PCS		PCS		PCS		PCS
	PCS		PCS		PCS		PCS		PCS		PCS
	PCS		PCS		PCS		PCS		PCS		PCS

----- Falling Space 43.9 m²
Max Falling Height 0000 mm

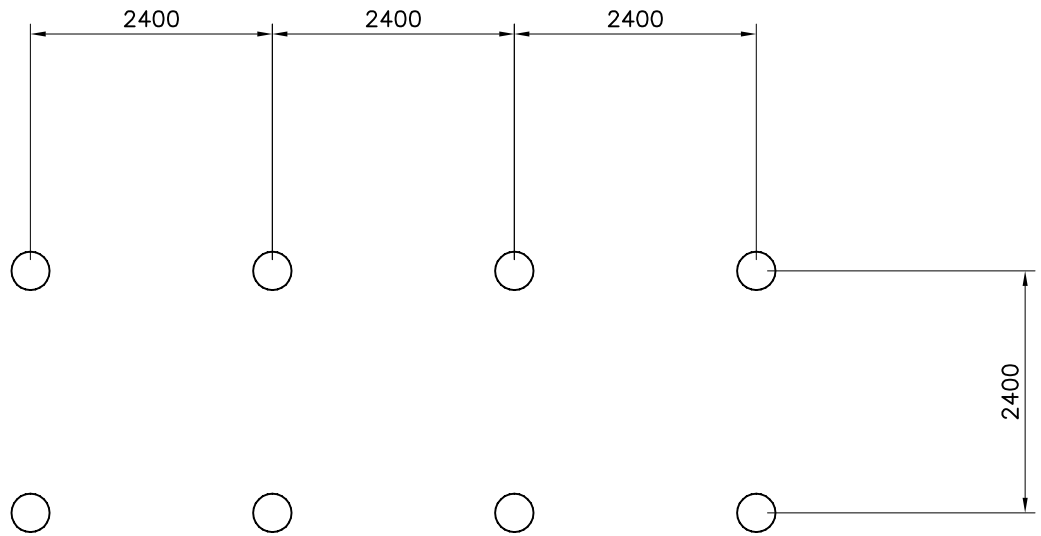

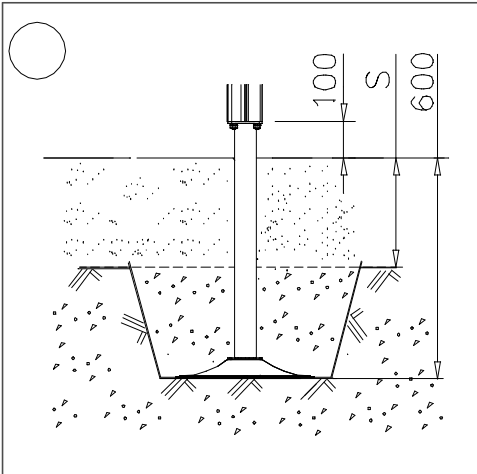

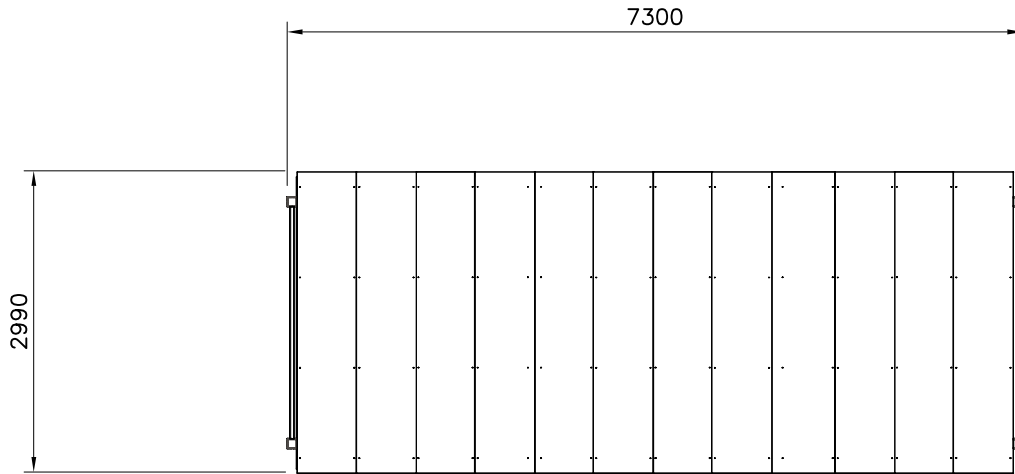
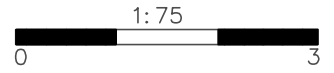

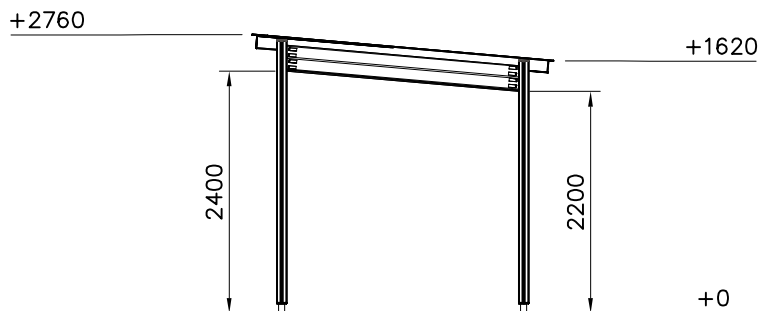
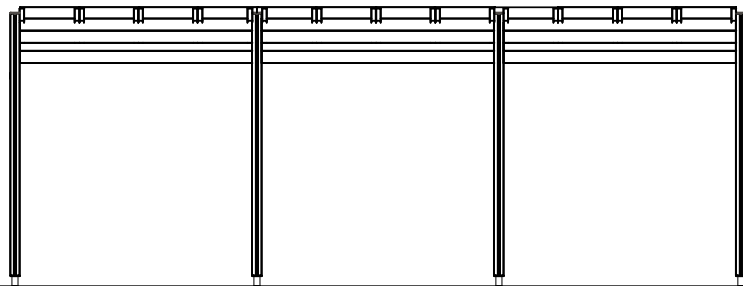

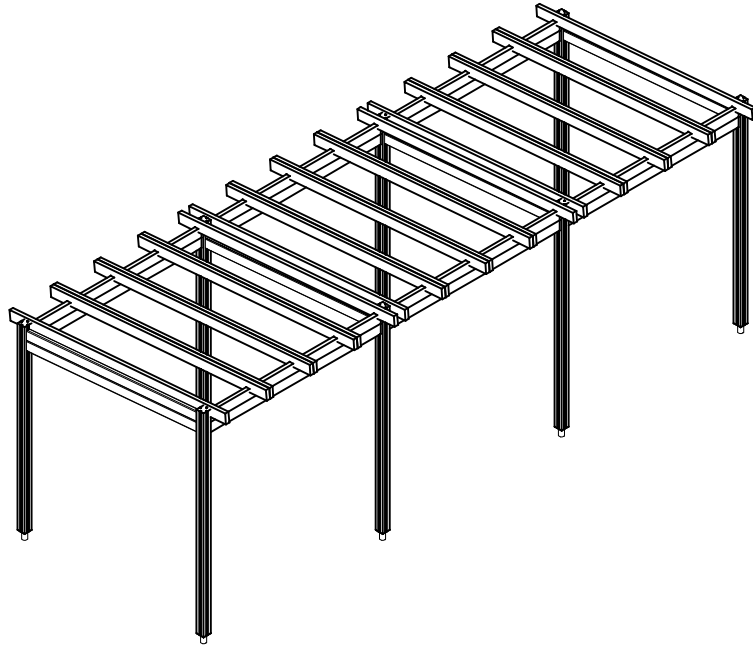
DET 2

DET 4

DET 1

DET 3

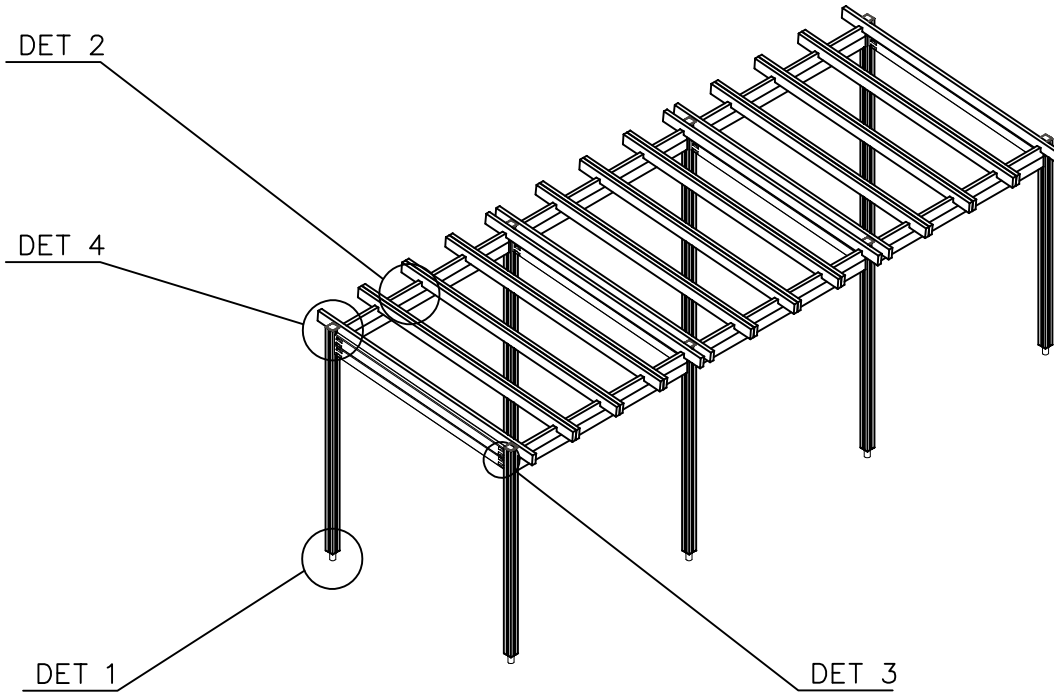

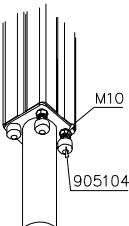
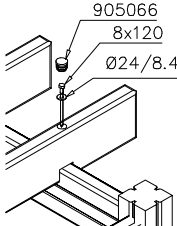
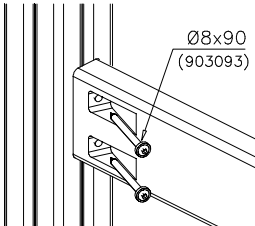
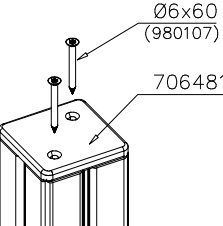
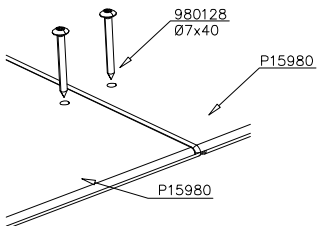
<p>DET 1</p> 	<p>DET 2</p> 	<p>DET 3</p> 	<p>DET 4</p> 
<p>DET 5</p> 			

DATE: 21.8.2024

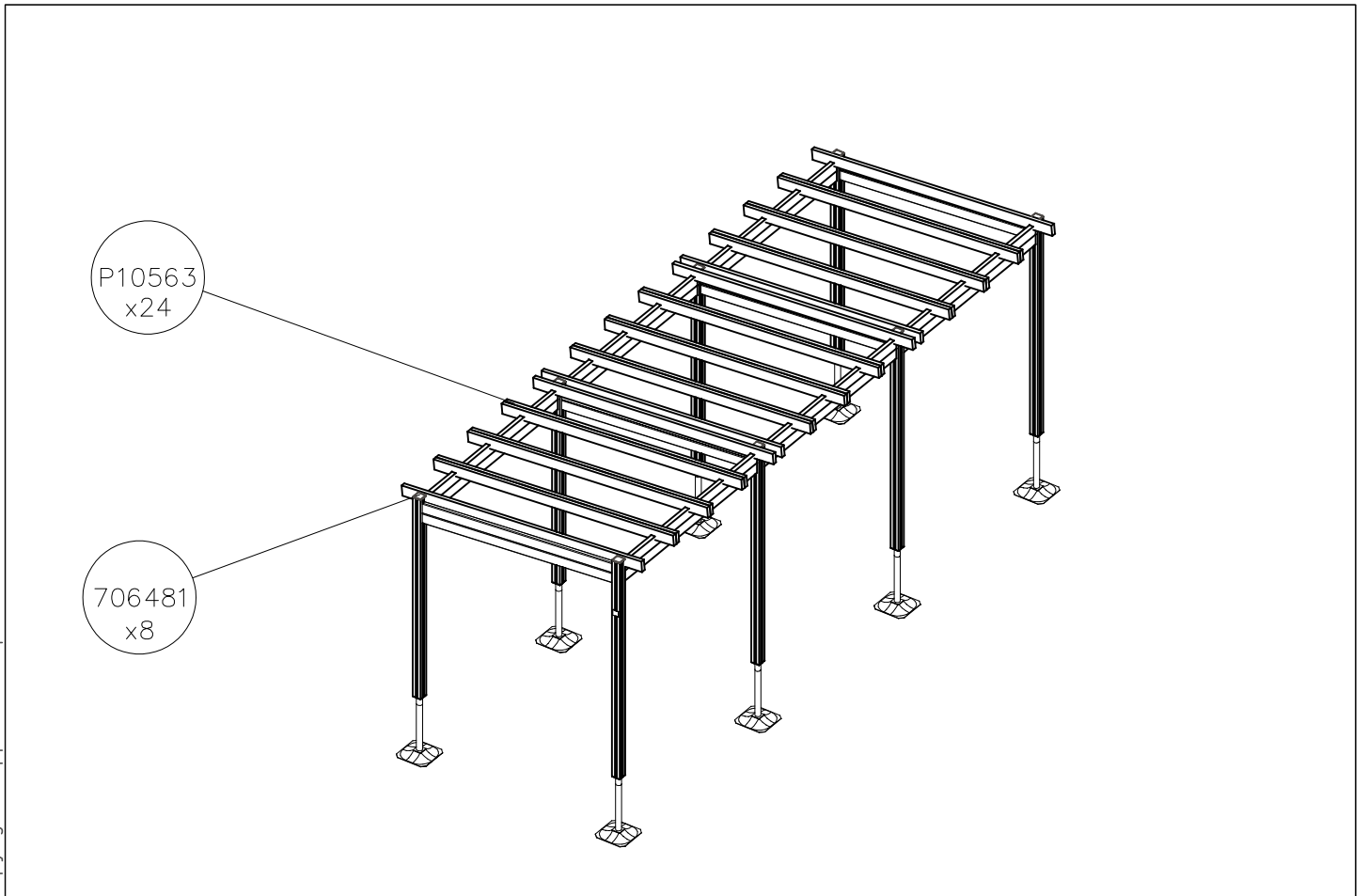
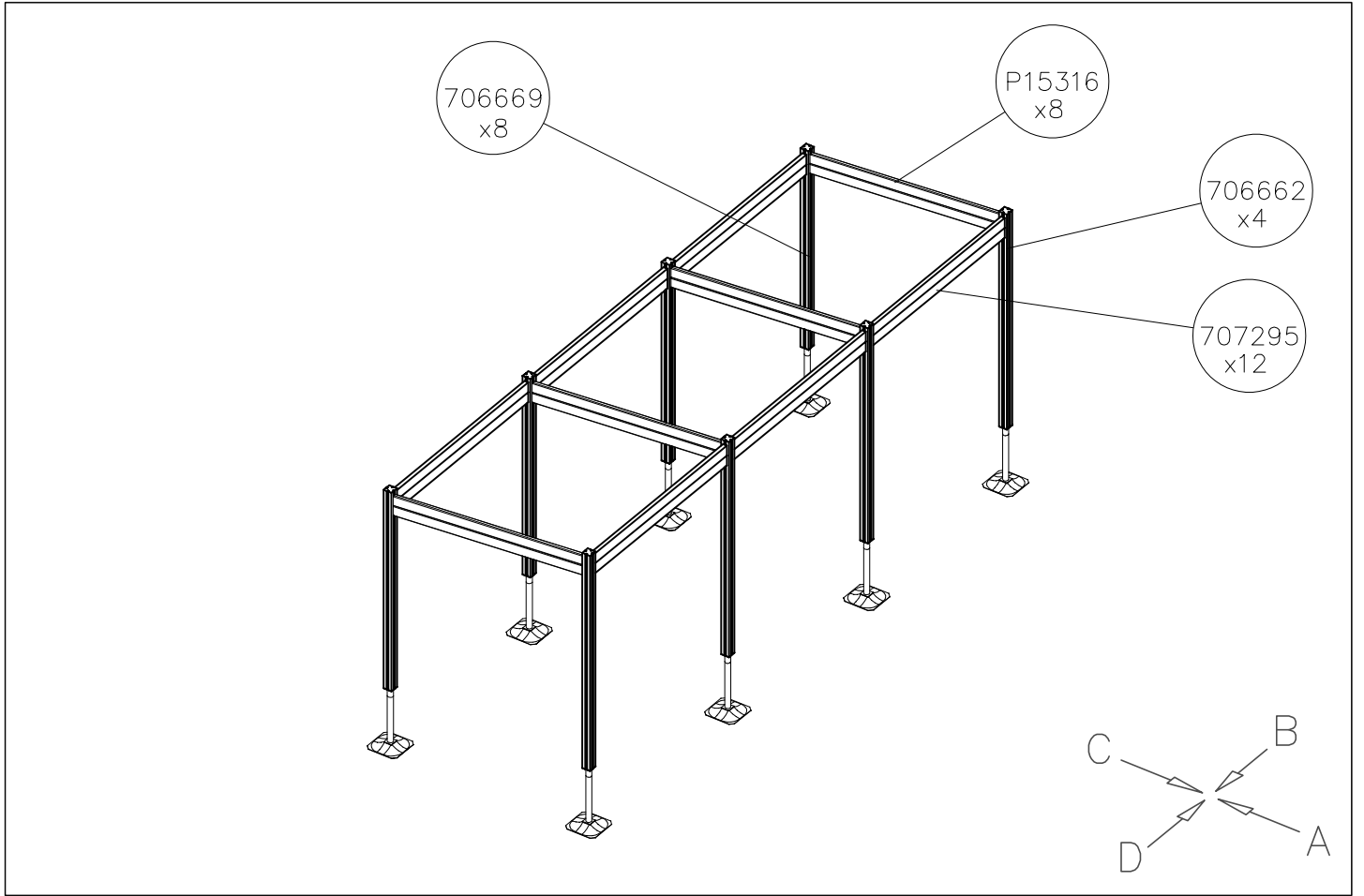

DATE: 21.8.2024

1:100

(A)

(B)

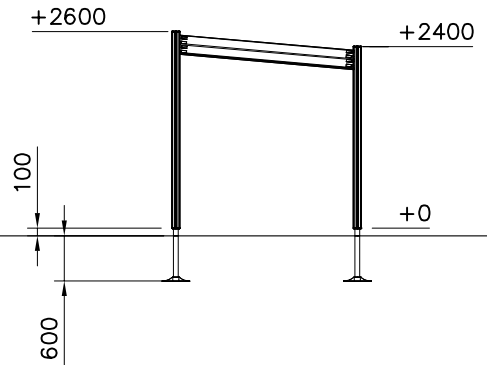
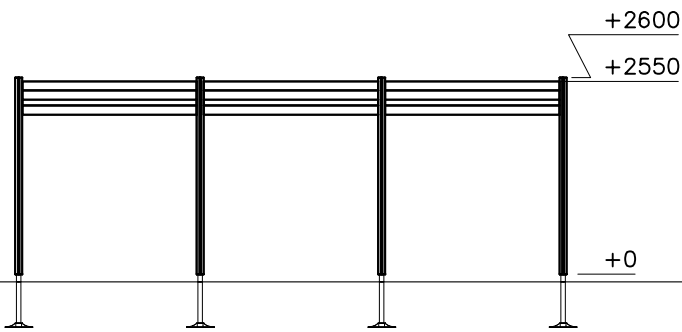

(C)

(D)

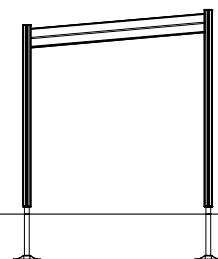
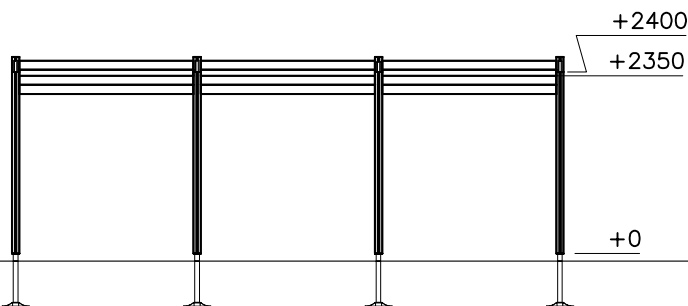

Start installing/positioning the roof plates from the middle towards the ends.
Ensure that plate holes are align with the beams before final fixing.
Pre-drill Ø5 mm holes through the roof plate holes to the roof beams.

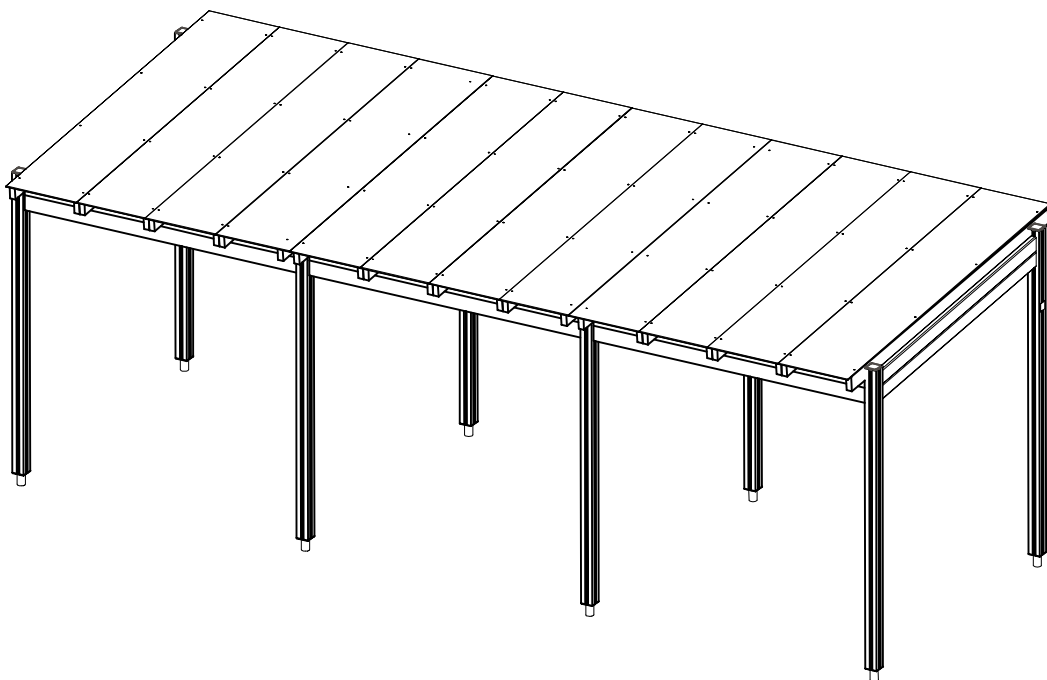
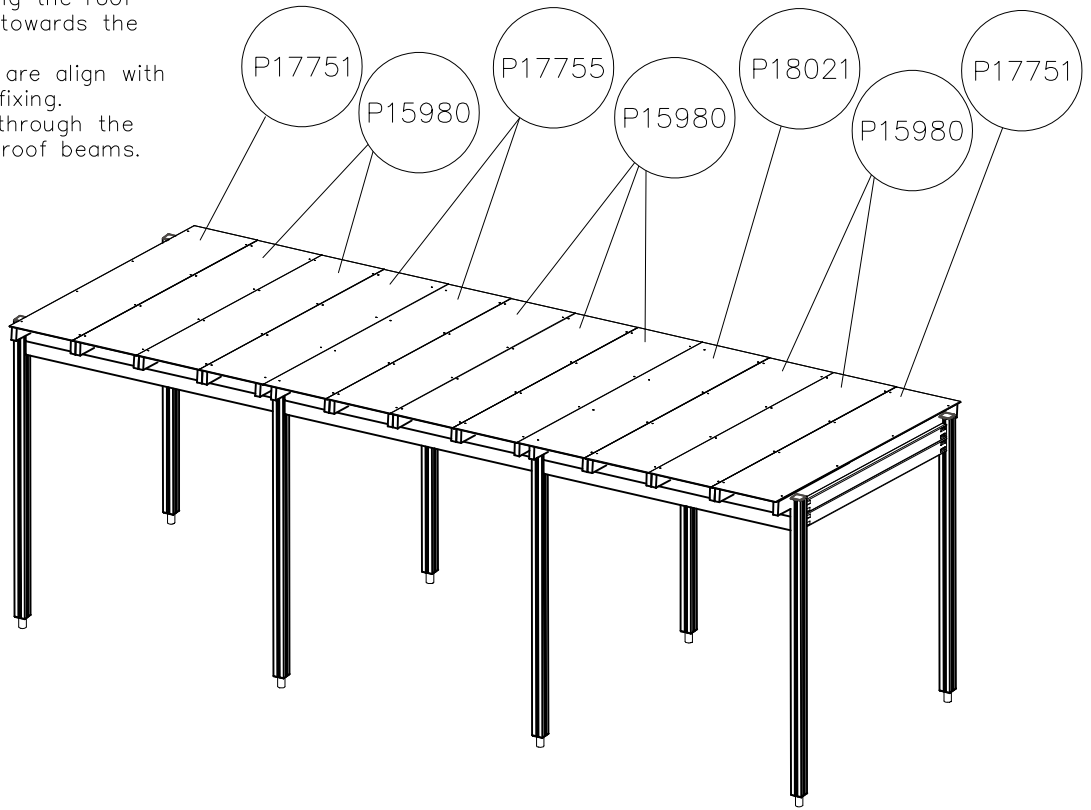

**Tuotekyltti tulee tuotteen mukana yhdellä seuraavista tavoista:****1) Metallinen tuotekyltti ja kiinnitysruuvit**

- Kiinnitä tuotekyltti ruuveilla tolppaan noin 2 metrin korkeuteen kuvan 1 mukaisesti.

2) Tuotekylttitarra

- Puhdista maalattu metalli- tai vaneripinta pölystä ja kosteudesta. Liimaa tarra kuvan 2 mukaisesti.
- Huom. Älä kiinnitä tarraa karheapintaiseen laminaattiin tai maalattuun puuhun.

Vår produktmärkning levereras på ett av följande sätt:**1) Produktskylt i metall**

- Fäst skylten med de medföljande skruvarna

2) Självhäftande produktetikett

- Rengör den pulverlackerade metallytan eller laminatyten så att den blir fri från smuts och fukt. Fäst etiketten enligt fig. 2.
- Obs! Fäst ej etiketten på detaljer med skrovlig yta eller på målat trä.

Product label is delivered by one of following ways:**1) Metal product label and screws**

- Fasten the label with screws.

2) Label sticker

- Clean the painted metal or plywood surface from dirt and moisture. Fasten the sticker as shown in the figure 2.
- Note. Do not attach the sticker to rough surfaced laminate or painted wood.

La plaque d'informations produit est livrée sous l'une de ces 3 formes :**1) Plaque métallique et vis**

- Fixez la plaque à l'aide des vis.

2) Etiquette autocollante

- Avant de coller l'étiquette, nettoyez le composant métallique peint ou la plaque de contreplaqué, de toute saleté. La surface doit être sèche (voir image 2).
- Attention, ne pas coller l'étiquette sur une surface lamellé-collée irrégulière ou sur du bois peint.

Die Auslieferung des Produktaufklebers erfolgt auf eine dieser Arten:**1) Produkt-Schild aus Metall incl. Schrauben**

- Die Befestigung des Schildes erfolgt mittels der Schrauben.

2) Aufkleber

- Entfernen Sie zunächst Schmutz und Feuchtigkeit vom lackierten Metall bzw. von der Holzoberfläche und bringen Sie den Aufkleber wie im Bild oben rechts beschrieben auf den gesäuberten Untergrund auf.
- Beachten Sie: Bringen Sie den Aufkleber nicht auf raues laminiertes oder lackiertes Holz an.

LAPPSET®
DEEP FOUNDATION

FOOT

DATE: 13.3.2014

4A

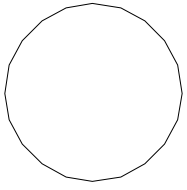

LAPPSET® BETON FOUNDATION

FOOT

DATE: 27.10.2015

1(1)

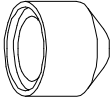
② 905104	PCS		PCS
	4		
 M10	PCS		PCS



905104

LAPPSET® DEEP FOUNDATION

FOOT

DATE: 15.5.2018

1(1)



①	909511	PCS	②	909519	PCS
		1			1
	90x90x650			50x380x380	

③	909637	PCS	④	909638	PCS
		4			8
	M10			Ø20/10.5	

⑤	909639	PCS	⑥	905104	PCS
		4			4
	M10x25			M10	

OPTION FOOT

①	911155	PCS			PCS
		1			
	90x90x650				