

LAPPSET®

FINNO



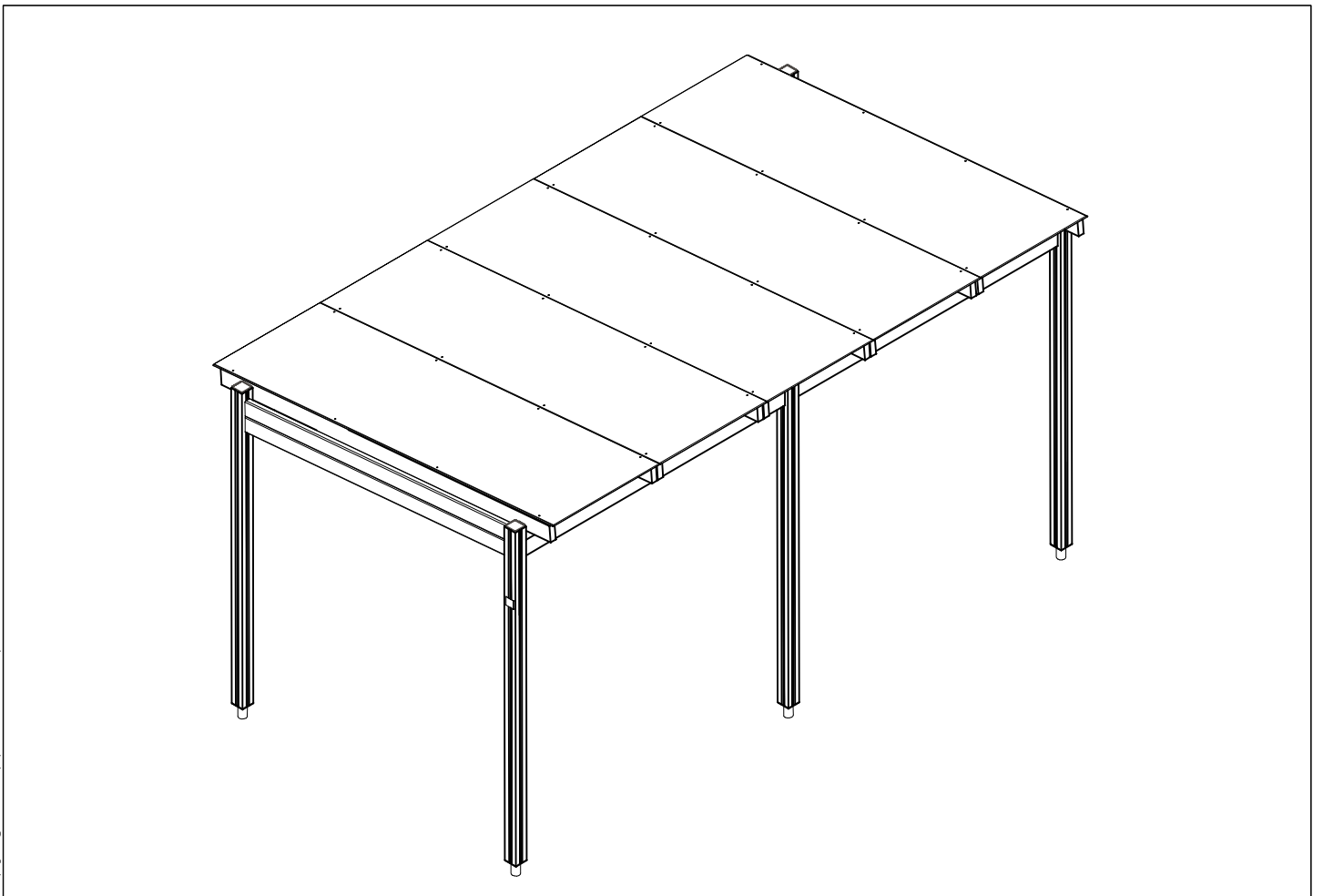

ASENNUSOHJE
MONTERINGSANSVISNING
INSTALLATION INSTRUCTION
AUFBAUANLEITUNG
NOTICE D'INSTALLATION

DATE: 1.7.2024

Q15851-5

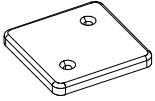
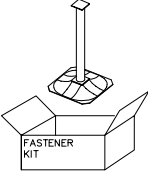
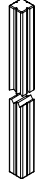

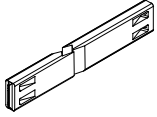
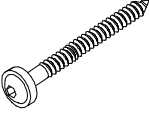
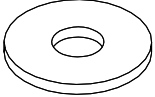
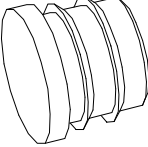
DATE: 1.7.2024

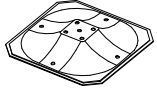
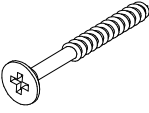
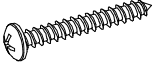
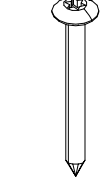
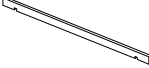
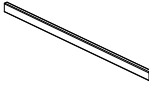
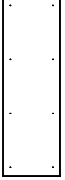
| | | | | | | | | | | | |
|--|-----|---|-----|--|-----|---|-----|---|-----|--|-----|
| 702286 | PCS | 706481-704 | PCS | 706531 | PCS | 706664-602 | PCS | 706669-602 | PCS | 707295-602 | PCS |
|  | 1 |  | 6 |  | 6 |  | 3 |  | 3 |  | 8 |
| 65x65 | | 83x83x10 | | | | 93x93x2540 | | 93x93x2400 | | L 2304 | |
| 903093 | PCS | 905051 | PCS | 905066 | PCS | 909232 | PCS | 909511 | PCS | 909519 | PCS |
|  | 56 |  | 20 |  | 20 |  | 20 |  | 6 |  | 6 |
| Ø8x90 | | Ø24/8.4 | | S30H | | 8x120 | | 90x90x650 | | 50x380x380 | |
| 980107 | PCS | 980114 | PCS | 980128 | PCS | P10563-602 | PCS | P15316 | PCS | P15980-704 | PCS |
|  | 12 |  | 4 |  | 40 |  | 10 |  | 6 |  | 5 |
| Ø6x60 | | Ø4x20 | | Ø7x40 | | L 2900 | | | | 10x950x3000 | |
| | PCS | | PCS | | PCS | | PCS | | PCS | | PCS |
| | | | | | | | | | | | |
| | PCS | | PCS | | PCS | | PCS | | PCS | | PCS |
| | | | | | | | | | | | |
| | PCS | | PCS | | PCS | | PCS | | PCS | | PCS |
| | | | | | | | | | | | |

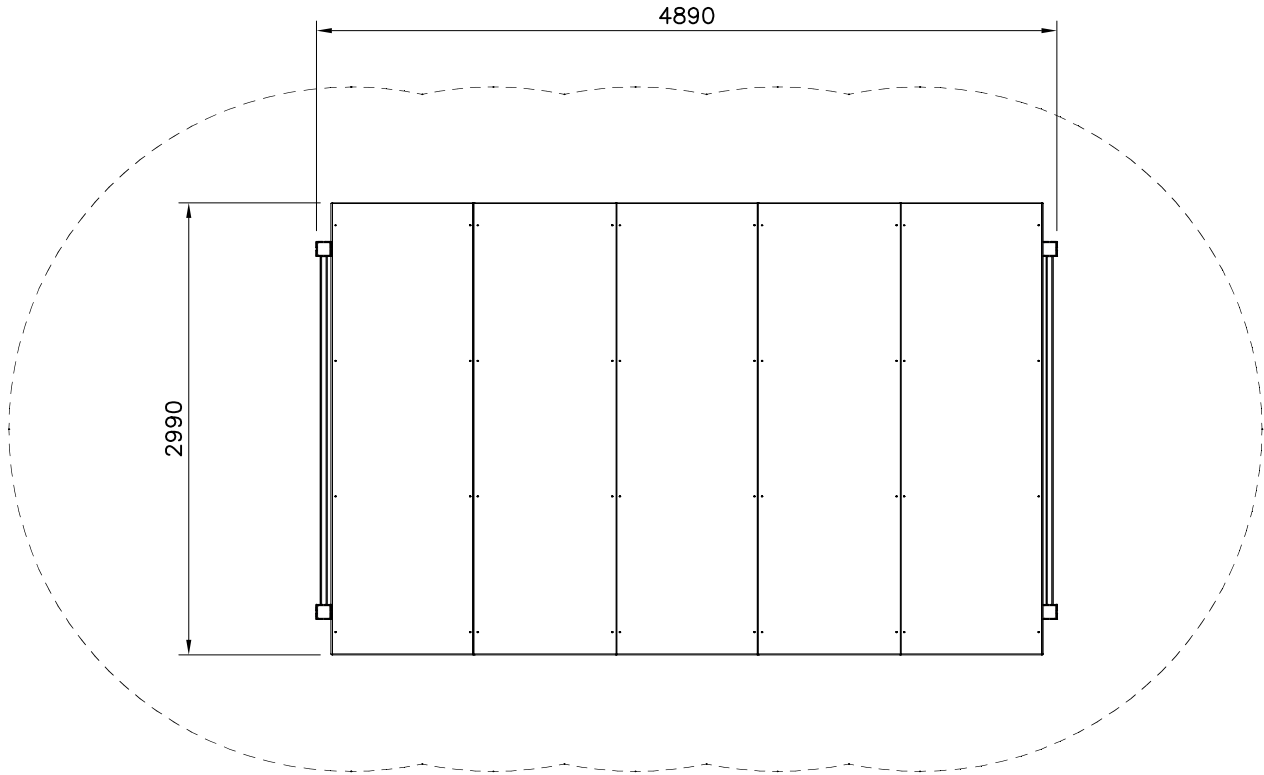
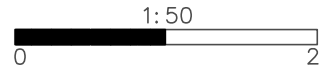

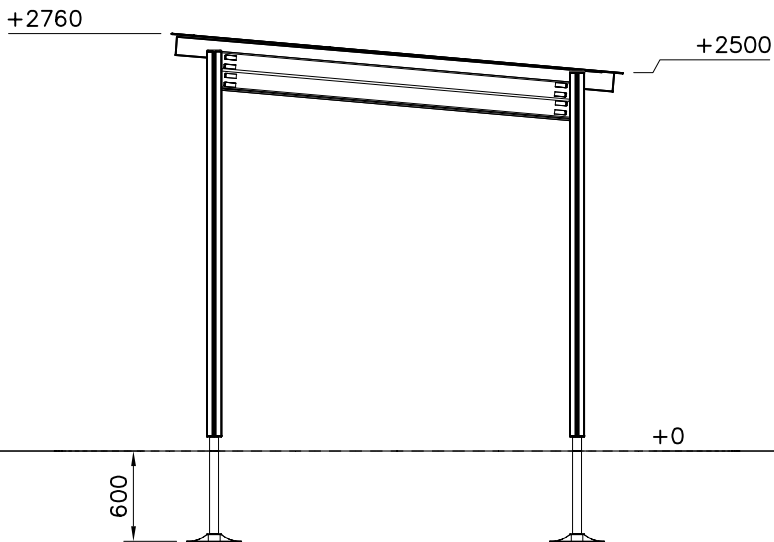
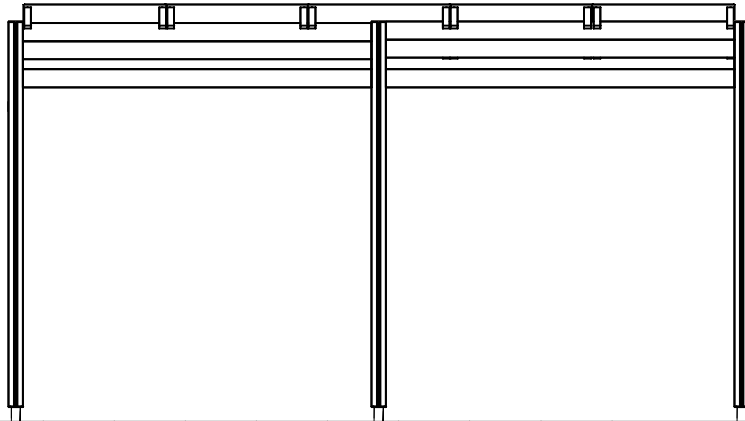

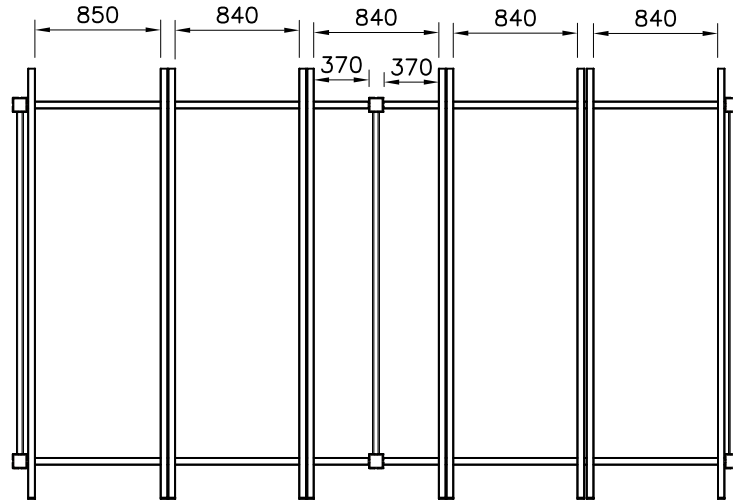

Start installing/positioning the roof plates from the middle towards the ends.

Ensure that plate holes align with the beams before final fixing. Pre-drill $\varnothing 5$ mm holes through the roof plate holes to the roof beams.

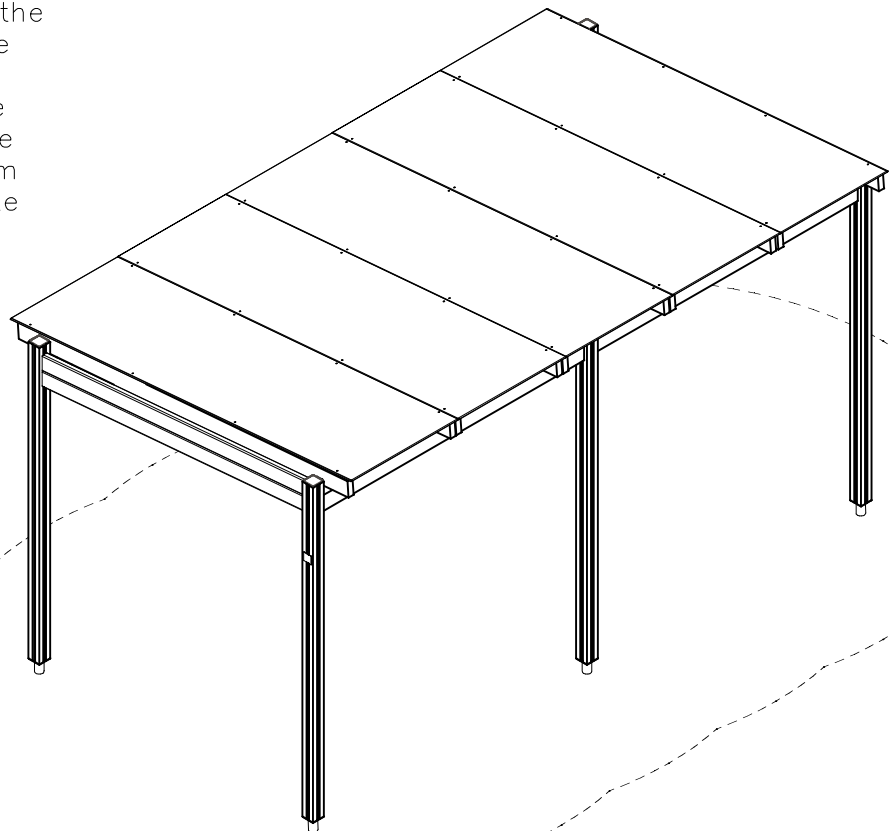

**Tuotekyltti tulee tuotteen mukana yhdellä seuraavista tavoista:****1) Metallinen tuotekyltti ja kiinnitysruuvit**

- Kiinnitä tuotekyltti ruuveilla tolppaan noin 2 metrin korkeuteen kuvan 1 mukaisesti.

2) Tuotekyltitarra

- Puhdista maalattu metalli- tai vaneripinta pölystä ja kosteudesta. Liimaa tarra kuvan 2 mukaisesti.
- Huom. Älä kiinnitä tarraa karheapintaiseen laminaattiin tai maalattuun puuhun.

Vår produktmärkning levereras på ett av följande sätt:**1) Produktskylt i metall**

- Fäst skylten med de medföljande skruvarna

2) Självhäftande produktetikett

- Rengör den pulverlackerade metallytan eller laminatyten så att den blir fri från smuts och fukt. Fäst etiketten enligt fig. 2.
- Obs! Fäst ej etiketten på detaljer med skrovlig yta eller på målat trä.

Product label is delivered by one of following ways:**1) Metal product label and screws**

- Fasten the label with screws.

2) Label sticker

- Clean the painted metal or plywood surface from dirt and moisture. Fasten the sticker as shown in the figure 2.
- Note. Do not attach the sticker to rough surfaced laminate or painted wood.

La plaque d'informations produit est livrée sous l'une de ces 3 formes :**1) Plaque métallique et vis**

- Fixez la plaque à l'aide des vis.

2) Etiquette autocollante

- Avant de coller l'étiquette, nettoyez le composant métallique peint ou la plaque de contreplaqué, de toute saleté. La surface doit être sèche (voir image 2).
- Attention, ne pas coller l'étiquette sur une surface lamellé-collée irrégulière ou sur du bois peint.

Die Auslieferung des Produktaufklebers erfolgt auf eine dieser Arten:**1) Produkt-Schild aus Metall incl. Schrauben**

- Die Befestigung des Schildes erfolgt mittels der Schrauben.

2) Aufkleber

- Entfernen Sie zunächst Schmutz und Feuchtigkeit vom lackierten Metall bzw. von der Holzoberfläche und bringen Sie den Aufkleber wie im Bild oben rechts beschrieben auf den gesäuberten Untergrund auf.
- Beachten Sie: Bringen Sie den Aufkleber nicht auf raues laminiertes oder lackiertes Holz an.

LAPPSET®
DEEP FOUNDATION

FOOT

DATE: 13.3.2014

4A



LAPPSET®
BETON FOUNDATION

FOOT

DATE: 27.10.2015

1(1)

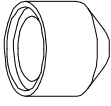
| | | | |
|--|-----|--|-----|
| ② 905104 | PCS | | PCS |
| | 4 | | |
|  M10 | PCS | | PCS |
| | | | |



905104

LAPPSET® DEEP FOUNDATION

FOOT

DATE: 15.5.2018

1(1)



| | | | | | |
|---|-----------|-----|---|------------|-----|
| ① | 909511 | PCS | ② | 909519 | PCS |
| | | 1 | | | 1 |
| | 90x90x650 | | | 50x380x380 | |

| | | | | | |
|---|--------|-----|---|----------|-----|
| ③ | 909637 | PCS | ④ | 909638 | PCS |
| | | 4 | | | 8 |
| | M10 | | | Ø20/10.5 | |

| | | | | | |
|---|--------|-----|---|--------|-----|
| ⑤ | 909639 | PCS | ⑥ | 905104 | PCS |
| | | 4 | | | 4 |
| | M10x25 | | | M10 | |

OPTION FOOT

| | | | | | |
|---|-----------|-----|--|--|-----|
| ① | 911155 | PCS | | | PCS |
| | | 1 | | | |
| | 90x90x650 | | | | |