

LAPPSET®

PROMENADE









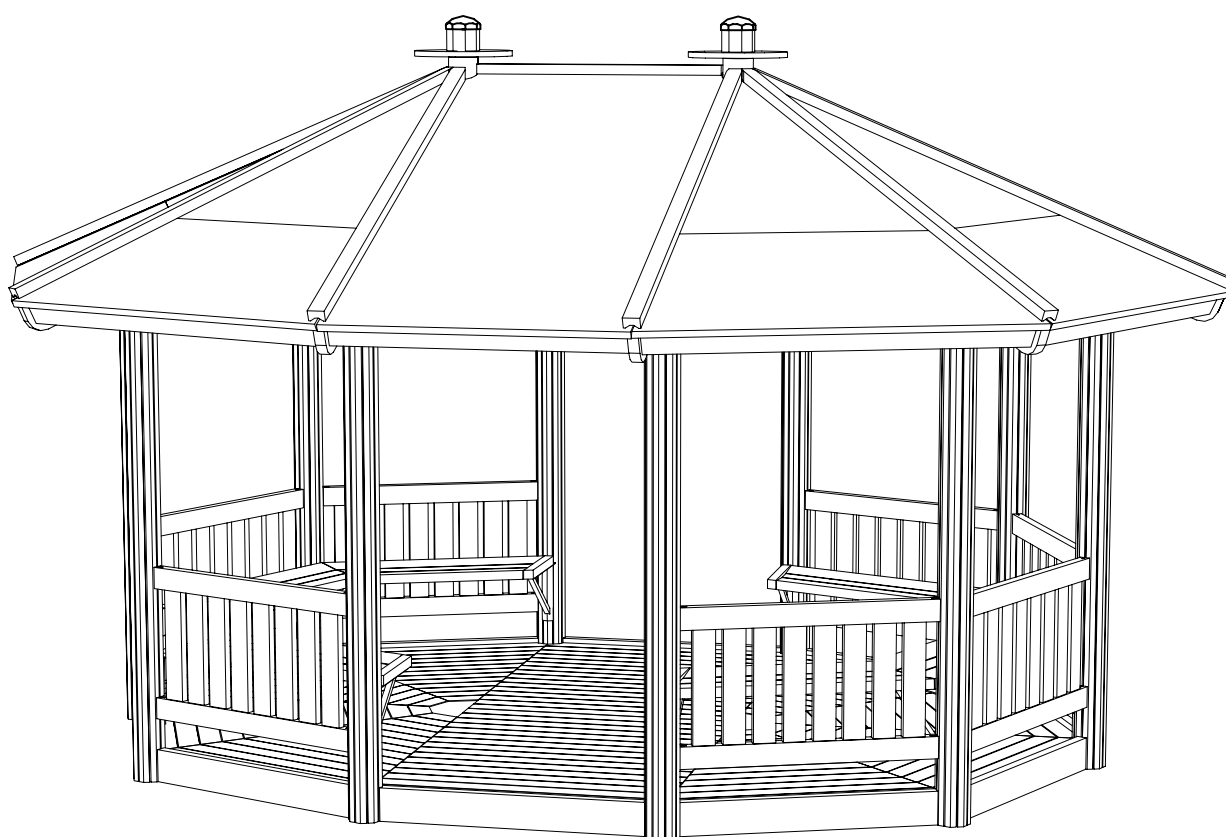

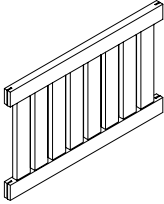

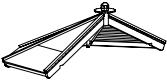

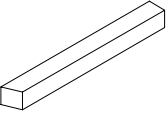
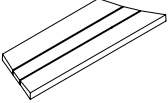
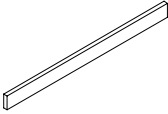
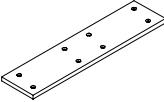
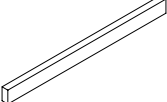
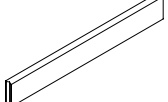
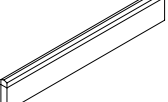
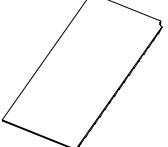
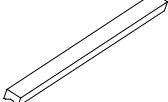
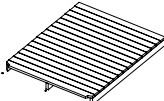
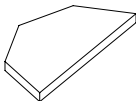
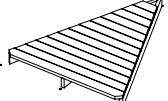
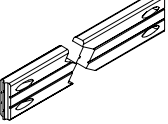
ASENNUSOHJE
MONTERINGSANSVISNING
INSTALLATION INSTRUCTION
AUFBAUANLEITUNG
NOTICE D'INSTALLATION

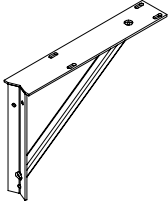
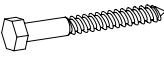
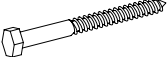
REF: 070205

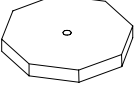
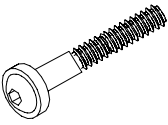
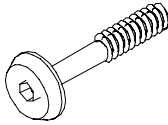
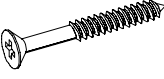
DATE: 16.11.2007

070205



003779  8 	PCS 8	007163  2 	PCS 2	007303  L 2240 10	PCS 10	007318  4	PCS 4	007342  8	PCS 8	007478  L 1279 4	PCS 4
007479  2	PCS 2	007483  2	PCS 2	007484  4	PCS 4	007485  1	PCS 1	007486  2	PCS 2	007487  1	PCS 1
007488  2	PCS 2	007489  2	PCS 2	007490  8	PCS 8	702349  L 1104 16	PCS 16	905051  Ø24/8.4 80	PCS 80	907092  10	PCS 10
909217  8x70 30	PCS 30	909238  8x90 80	PCS 80	909287  8x80 10	PCS 10	909667  300x300 12	PCS 12	909866  8x60 8	PCS 8	909868  8x50 32	PCS 32
980100  5x60 22	PCS 22	980101  4x70 52	PCS 52	980104  5x90 8	PCS 8	980105  5x120 4	PCS 4	980150  M8 50	PCS 50	980151  Ø16/8.4 90	PCS 90
	PCS		PCS		PCS		PCS		PCS		PCS
	PCS		PCS		PCS		PCS		PCS		PCS

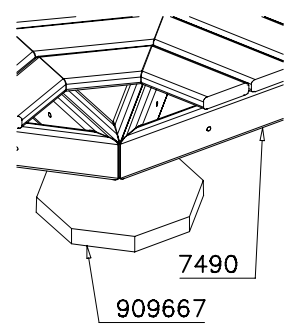
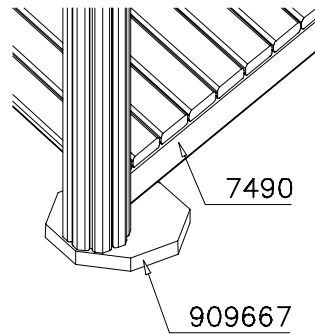
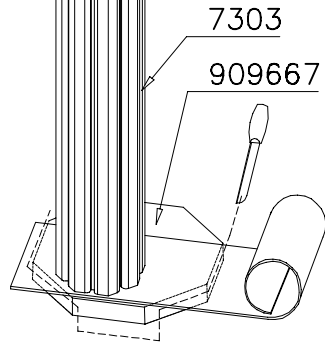
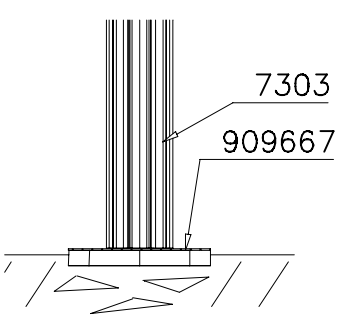
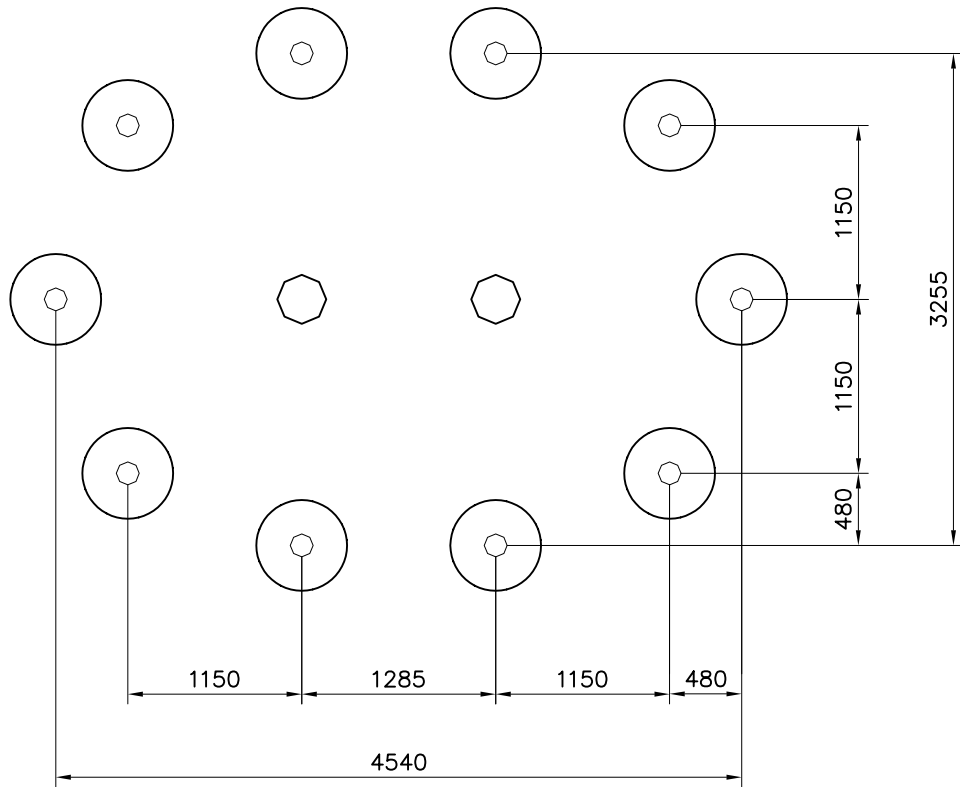
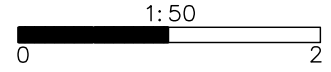

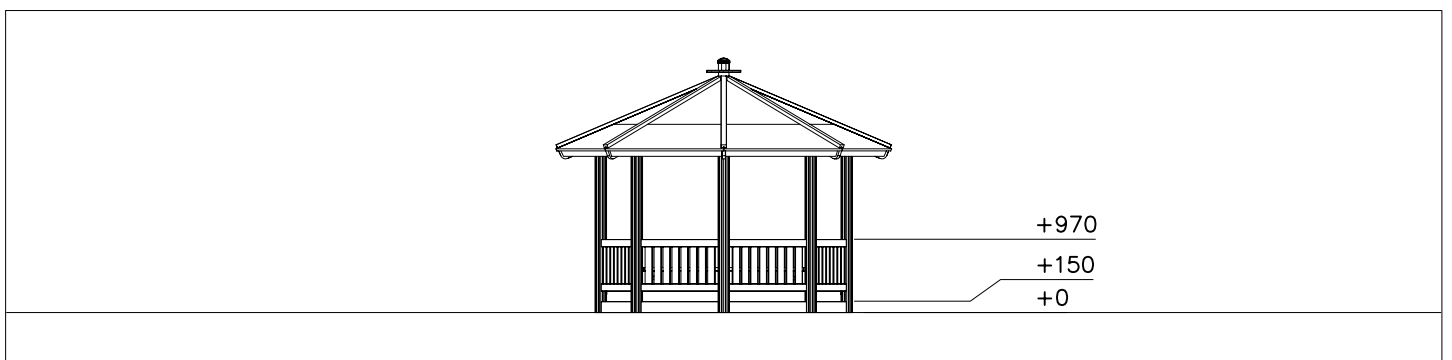
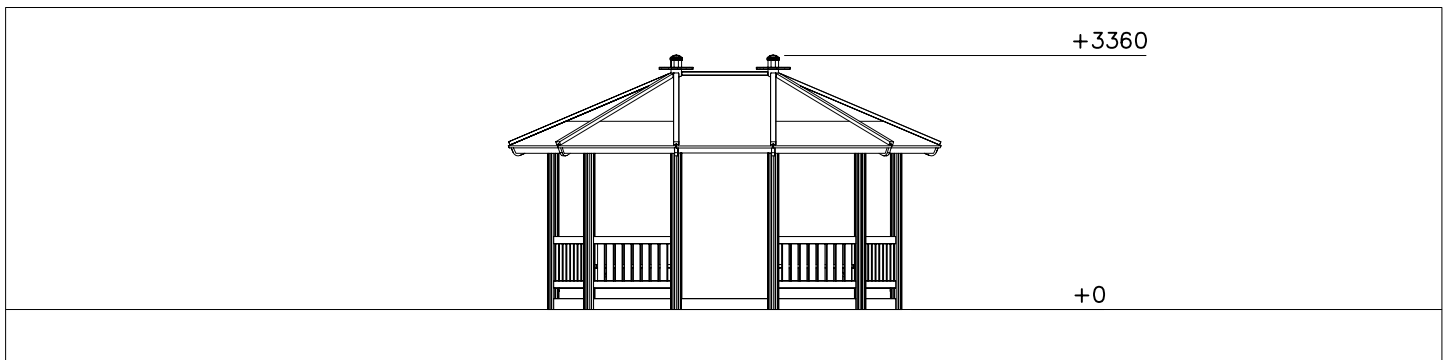
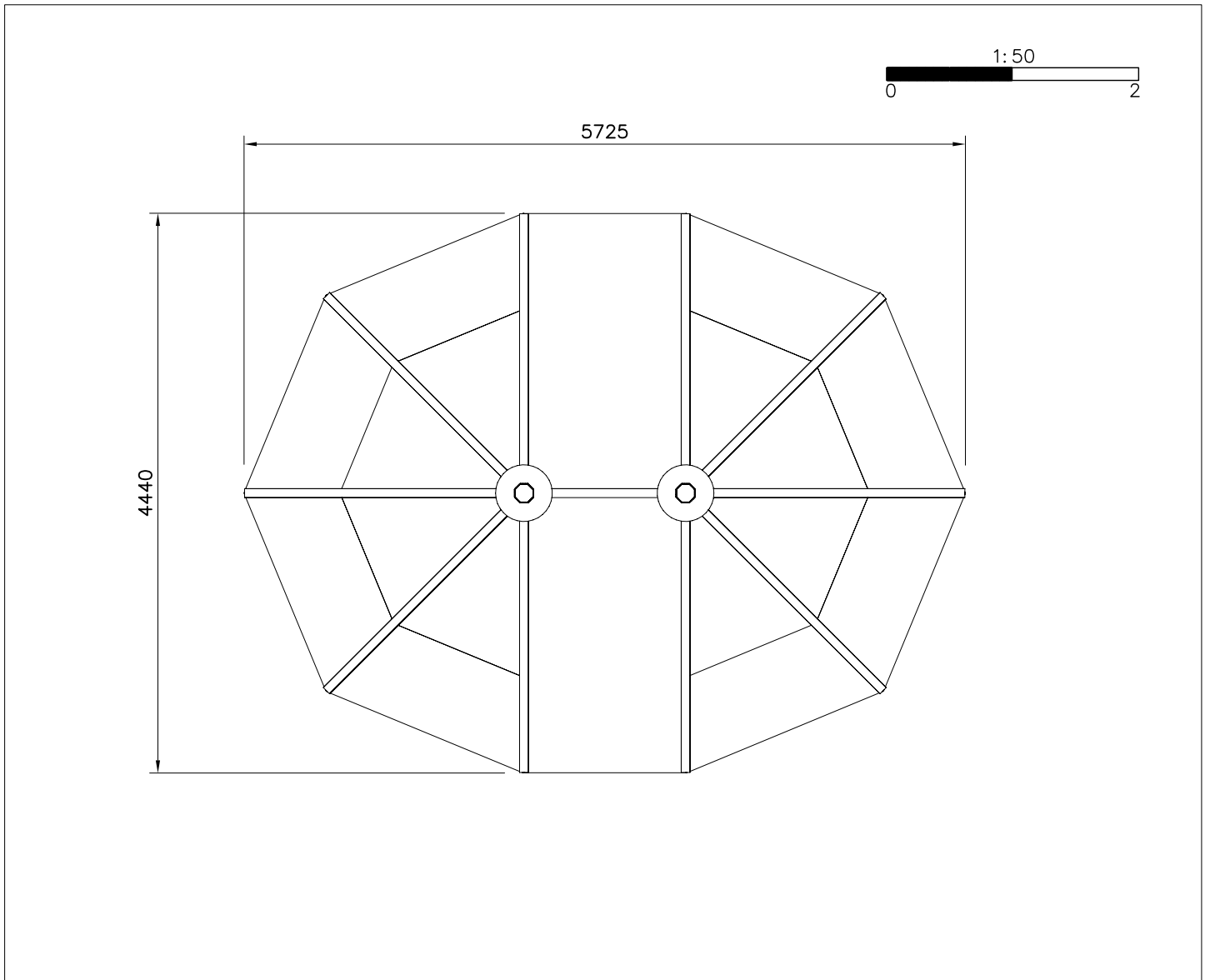

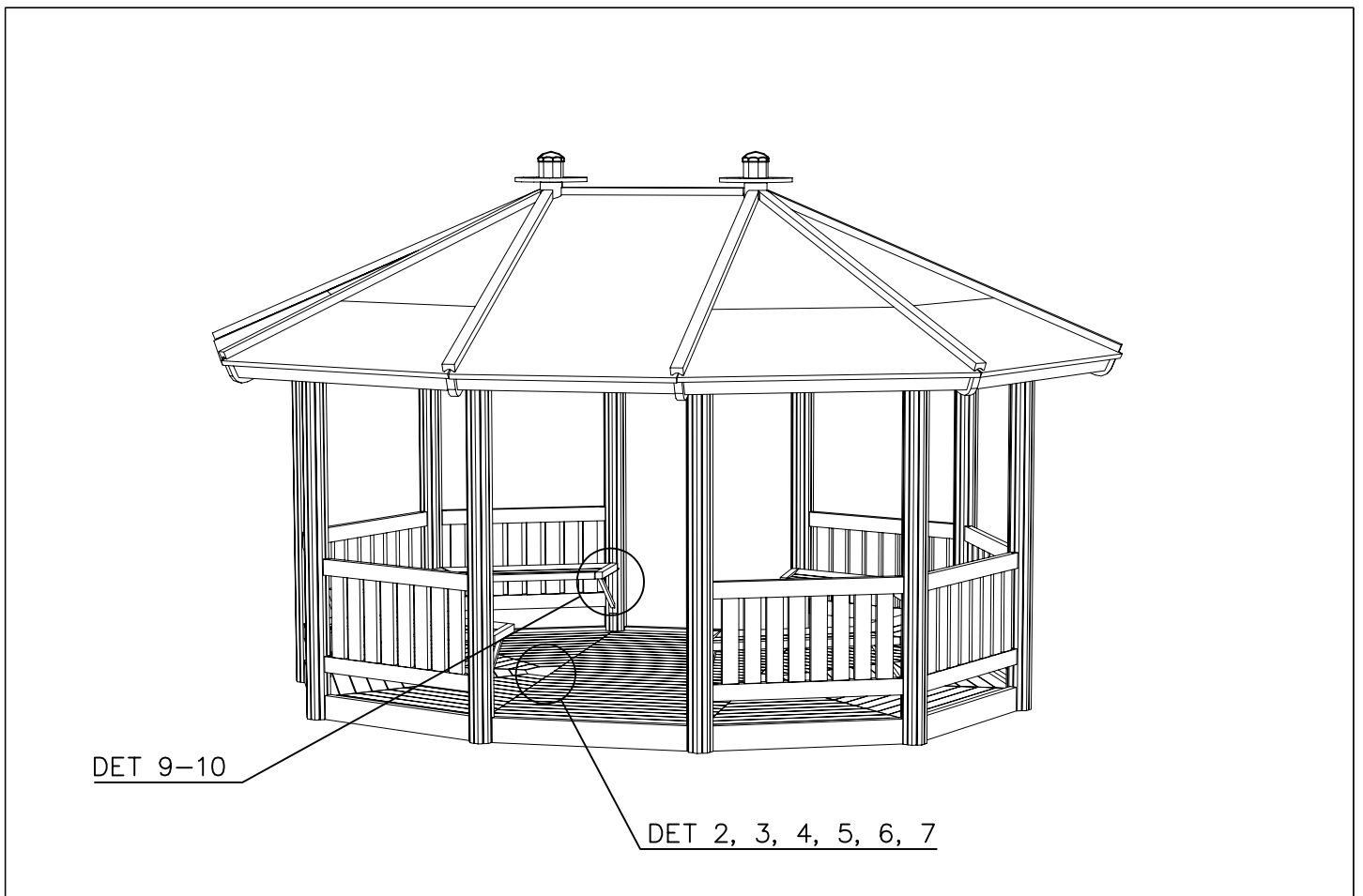
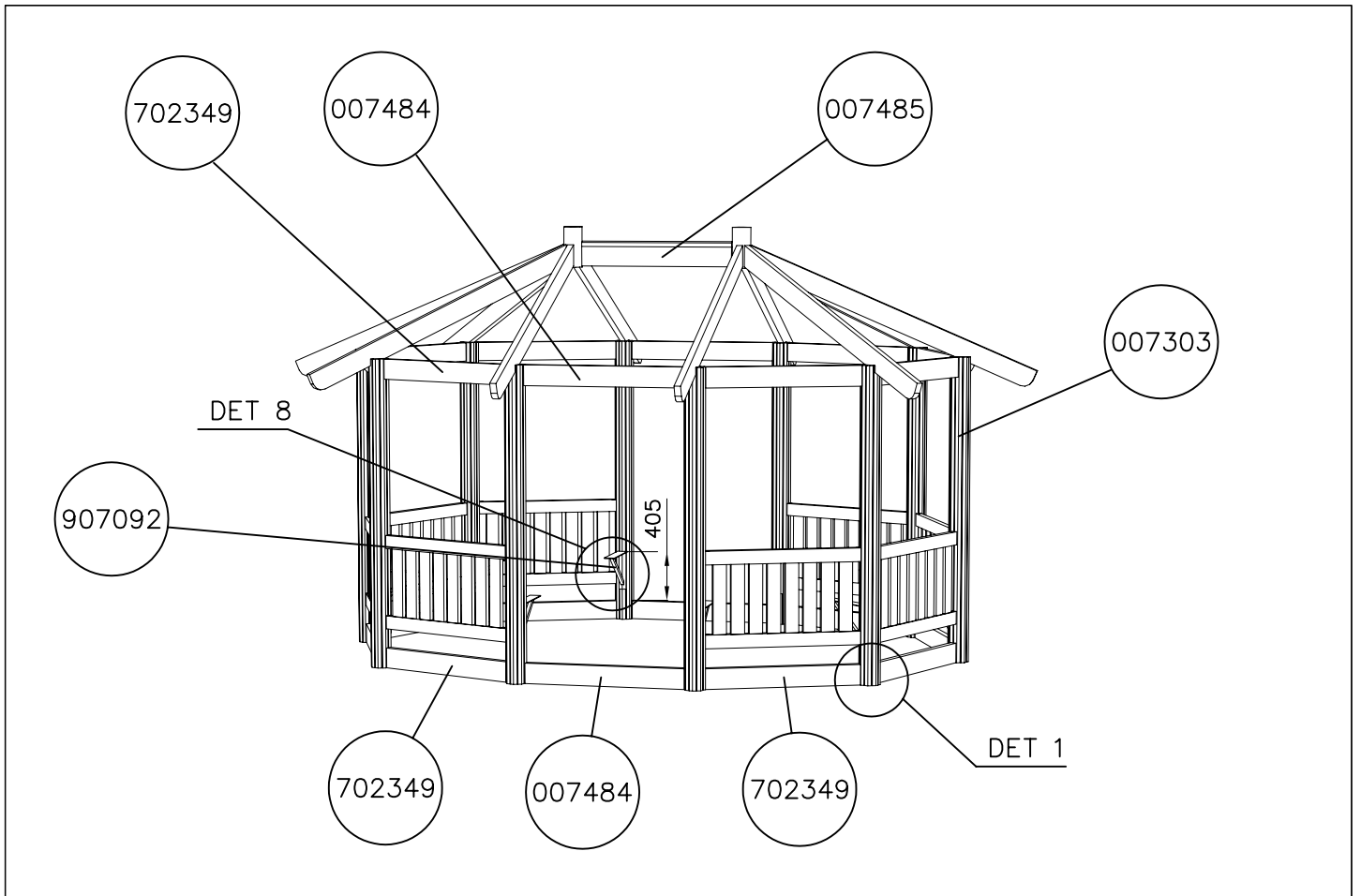

<p>DET 1</p> <p>8x90 Ø24/8.4</p>	<p>DET 2</p> <p>7490</p>	<p>DET 3</p> <p>7490 8x80</p>	<p>DET 4</p> <p>8x80 7488</p>
<p>DET 5</p> <p>7479 5x60</p>	<p>DET 6</p> <p>4x70 7478</p>	<p>DET 7</p> <p>5x60 7489 7490</p>	<p>DET 8</p> <p>907092 8x60 Ø16/8.4</p>
<p>DET 9</p> <p>007342 M8x50 Ø16/8.4 M8 907092</p>	<p>DET 10</p> <p>007318 M8x60 Ø16/8.4 M8 907092</p>		

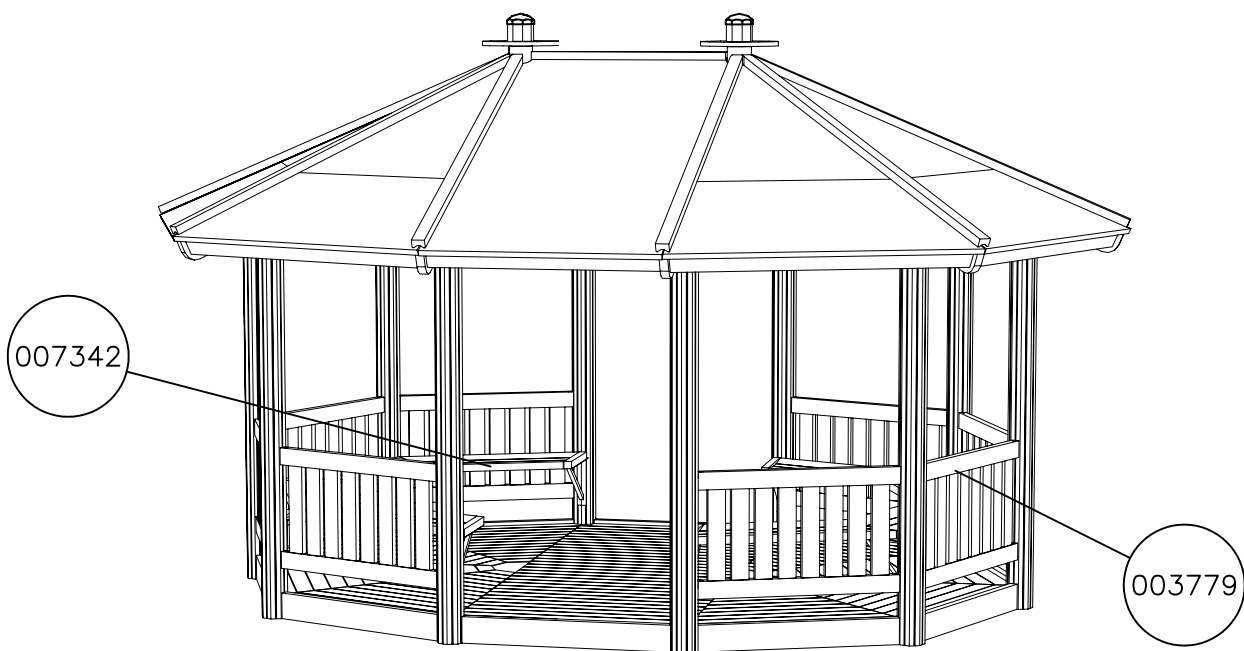
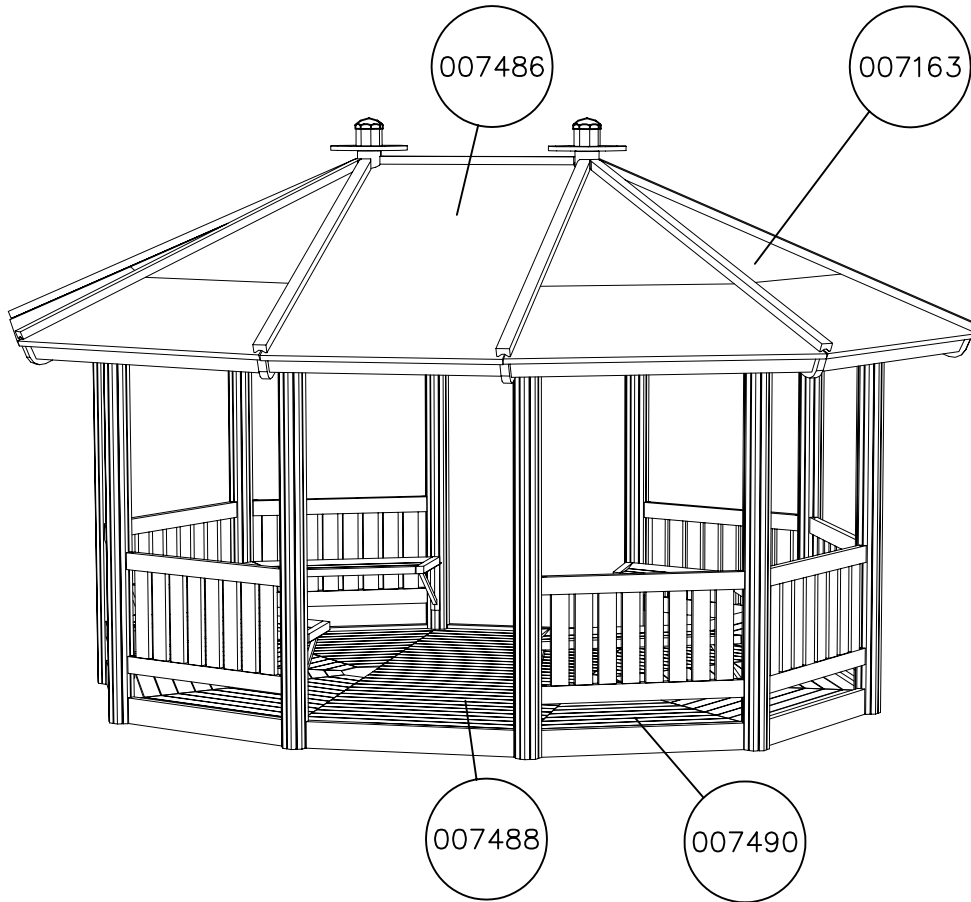

1. Tarkista pakkauslistan avulla, että olet saanut tarvitsemasi osat (s. 3).
2. Valitse huvimajalle paikka.
- *Tasoita alue. Mittaa perustuslaattojen (909667) paikat (s. 4). Jos pystytät huvimajan asfaltille tai betonilaatalle, et tarvitse perustuslaattoja.
3. Aloita pystytys kiinnittämällä tolpat (7303) toisiinsa puomeilla 702349 (s. 6, det 1). Tarkista, että teline on suorassa.
4. Aseta lattiaelementit huvimajan sisään ja kiinnitä ne toisiinsa (s. 6, det 2-6).
5. Asenna katto (007163, 007165) erillisen ohjeen mukaan.
6. Kiinnitä istuinkannattimet ja istuimet (s. 6, det 7-9).
7. Kiinnitä seinäelementit 3781 erillisen ohjeen mukaan.

1. Kolla med hjälp av följesedeln att du erhållit önskade komponenter (sid. 3).
2. Välj lämplig plats för paviljongen och plangör ytan. Mät ut och markera platsen (sid. 4) för golvelementen (909667).
3. Börja monteringen med att fästa stolparna (7303) till varandra med hjälp av bommarna 702349 (sid. 6, det 1).
4. Lägg in golvelementen och fäst dem vid varandra (sid. 6, det 2-6).
5. Montera taket (007163, 007165) enligt separat anvisning.
6. Montera sitsbärarna och sitsarna (sid. 6, det 7-9).
7. Montera väggelementen enligt separat anvisning.







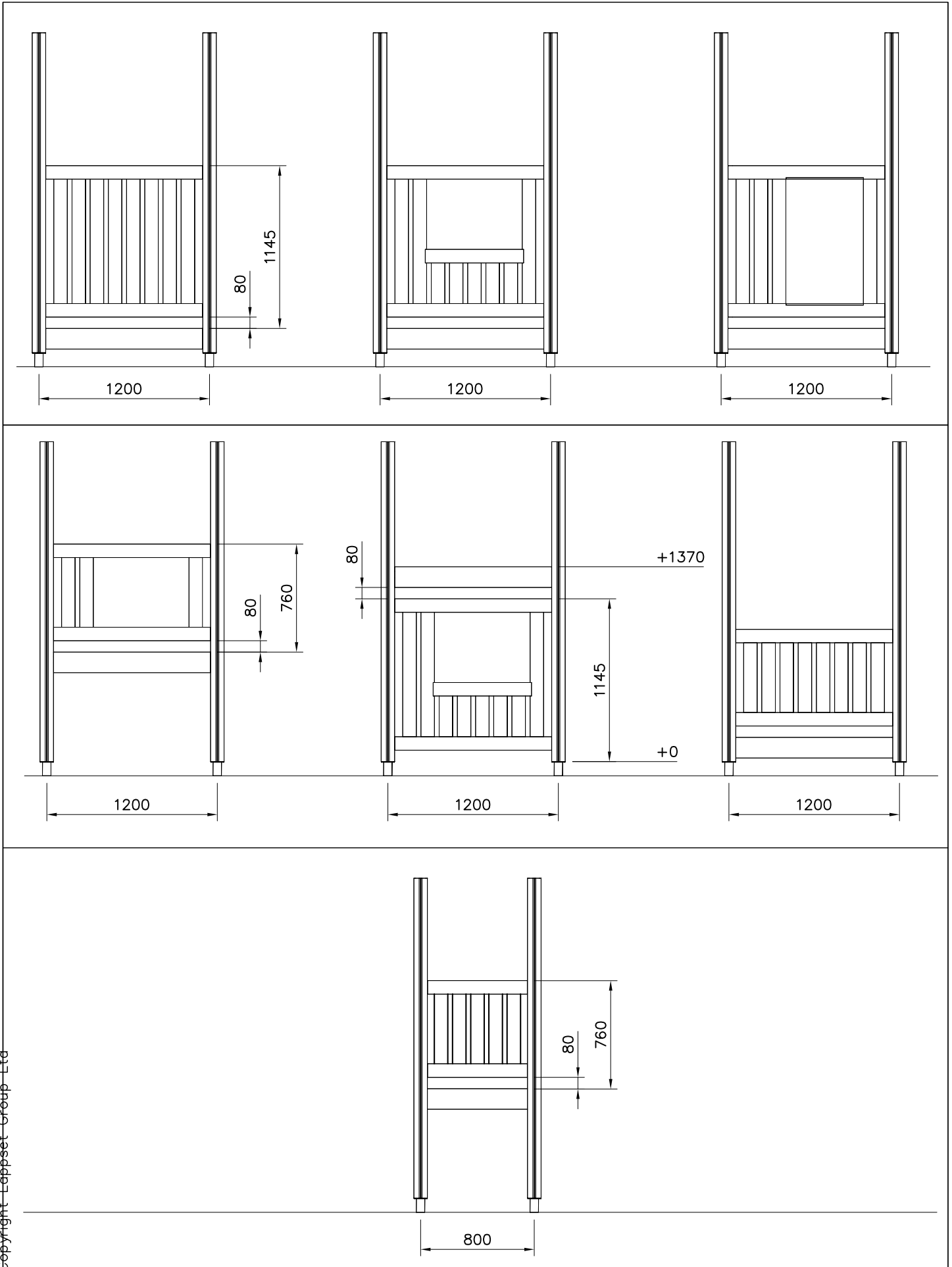

1. Use the packing list to check that none of the required components are missing (p. 3).
2. Select the location for the pavilion.
- *Level the ground. Measure the position (p. 4) for the base plates (909667).
3. Start the assembly work by connecting the posts (7303) to each other, using the 702349 beams (p. 6, det 1).
4. Install the floor elements inside the pavilion and fasten them to each other (p. 6, det 2-6).
5. Install the (007163, 007165) roof in accordance with instructions separately provided.
6. Secure the seat brackets and seats (p. 6, det 7-9).
7. Secure the wall elements in accordance with instructions separately provided.

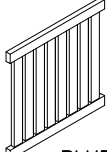
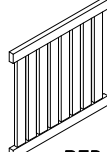
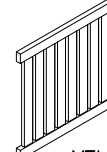
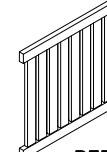
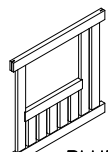
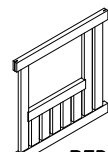
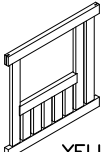
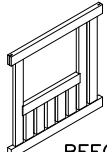
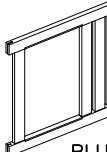
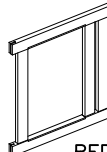
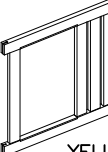
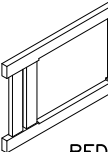
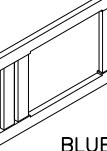
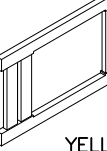
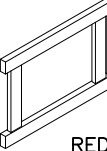
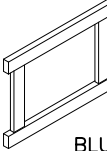
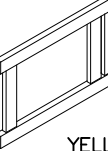
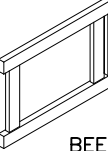
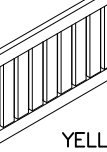
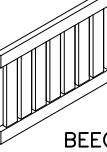
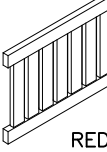
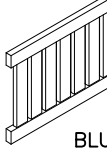
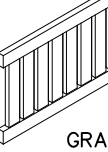
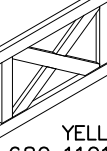
1. Prüfen Sie anhand der Packungsliste die Vollständigkeit der Lieferung (Seite 3)
2. Wählen Sie für den Pavillion einen geeigneten Standort aus. *Planieren Sie den Untergrund. Messen Sie die Stelle der Basisplatten aus (Seite 4). Wenn Sie den Pavillion auf Asphalt oder Betonplatten aufstellen, braucht es keine Basisplatten.
3. Zuerst werden die Pfosten (007303) mit den Balken (702349) befestigt (Seite 6, det 1).
4. Die Bodenlemente werden in den Pavillion ausgelegt, und miteinander befestigt. (Seite 6, det 2-7).
5. Montieren Sie das Dach (007163, 007165) anhand spezieller Montageanleitung.
6. Befestigen Sie die Sitzträger und die Sitze (Seite 6, det 8-10).
7. Befestigen Sie die Wandelemente 3779 anhand spezieller Montageanleitung.

1. Vérifier, à l'aide de la notice jointe dans l'emballage, que l'on a reçu toutes les pièces nécessaires (p. 3).
2. Choisir l'emplacement de l'équipement à installer.
*Égaliser la surface. Mesurer les emplacements (p. 4) des bases de poteaux (909667).
3. Commencer le montage par l'assemblage des poteaux (007303) les uns aux autres, à l'aide des poutres 702349 (p.6, det 1)
4. Installer les planchers du kiosque en les fixant les uns aux autres (p. 6, det 2-7).
5. Installer le toit (007163, 007165) comme indiqué dans la notice.
6. Fixer les supports de banquettes et les banquettes (p. 6, det 8-10).
7. Fixer les parois comme indiqué dans la notice.

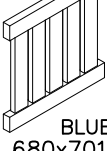
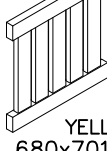
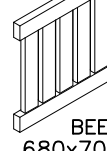
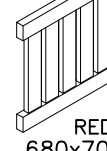
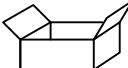
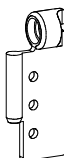
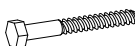



M 120	 003651 BLUE 1065x1101	PCS 1	 701307 RED 1065x1101	PCS 1	 701308 YELL 1065x1101	PCS 1	 003666 BEECH 1065x1101	PCS 1	 003650 BLUE 1065x1101	PCS 1	 701309 RED 1065x1101	PCS 1
	 701310 YELL 1065x1101	PCS 1	 003665 BEECH 1065x1101	PCS 1	 003652 BLUE 1065x1101	PCS 1	 701305 RED 1065x1101	PCS 1	 701306 YELL 1065x1101	PCS 1	 003656 RED 680x1101	PCS 1
	 701314 BLUE 680x1101	PCS 1	 701315 YELL 680x1101	PCS 1	 003660 RED 680x1101	PCS 1	 701312 BLUE 680x1101	PCS 1	 701313 YELL 680x1101	PCS 1	 003663 BEECH 680x1101	PCS 1
	 003659 YELL 680x1101	PCS 1	 003664 BEECH 680x1101	PCS 1	 003657 RED 680x1101	PCS 1	 003658 BLUE 680x1101	PCS 1	 701616 GRAY 680x1101	PCS 1		PCS
	 003653 YELL 680x1101	PCS 1	 003655 GRAY 680x1101	PCS 1		PCS		PCS	 003701 (003651) 701794 (701307) 701795 (701308) 008001 (003666) 003700 (003650) 701618 (701309) 701619 (701310) 008000 (003665)		 003786 (003657) 003787 (003658) 003779 (701616) 003788 (003659) 007999 (003664)	
	 701235 BLUE 680x701	PCS 1	 701270 YELL 680x701	PCS 1	 702292 BEECH 680x701	PCS 1	 701234 RED 680x701	PCS 1	003702 (003652) 701796 (701305) 701797 (701306) 003785 (003656) 701798 (701314) 701799 (701315)		003739 (003653) 003781 (003655) 702293 (702292) 701591 (701234) 701590 (701235) 701589 (701270)	
	PCS		PCS		PCS		PCS	003798 (003660) 701800 (701312) 701801 (701313) 007998 (003663)				
	PCS	 ① 909530	PCS 4	 ② 909217 8x70	PCS 4	 ③ 980151 Ø16/8.4	PCS 4	 ④ 905112 Ø22	PCS 4	 ⑤ 905120 Ø14	PCS 4	

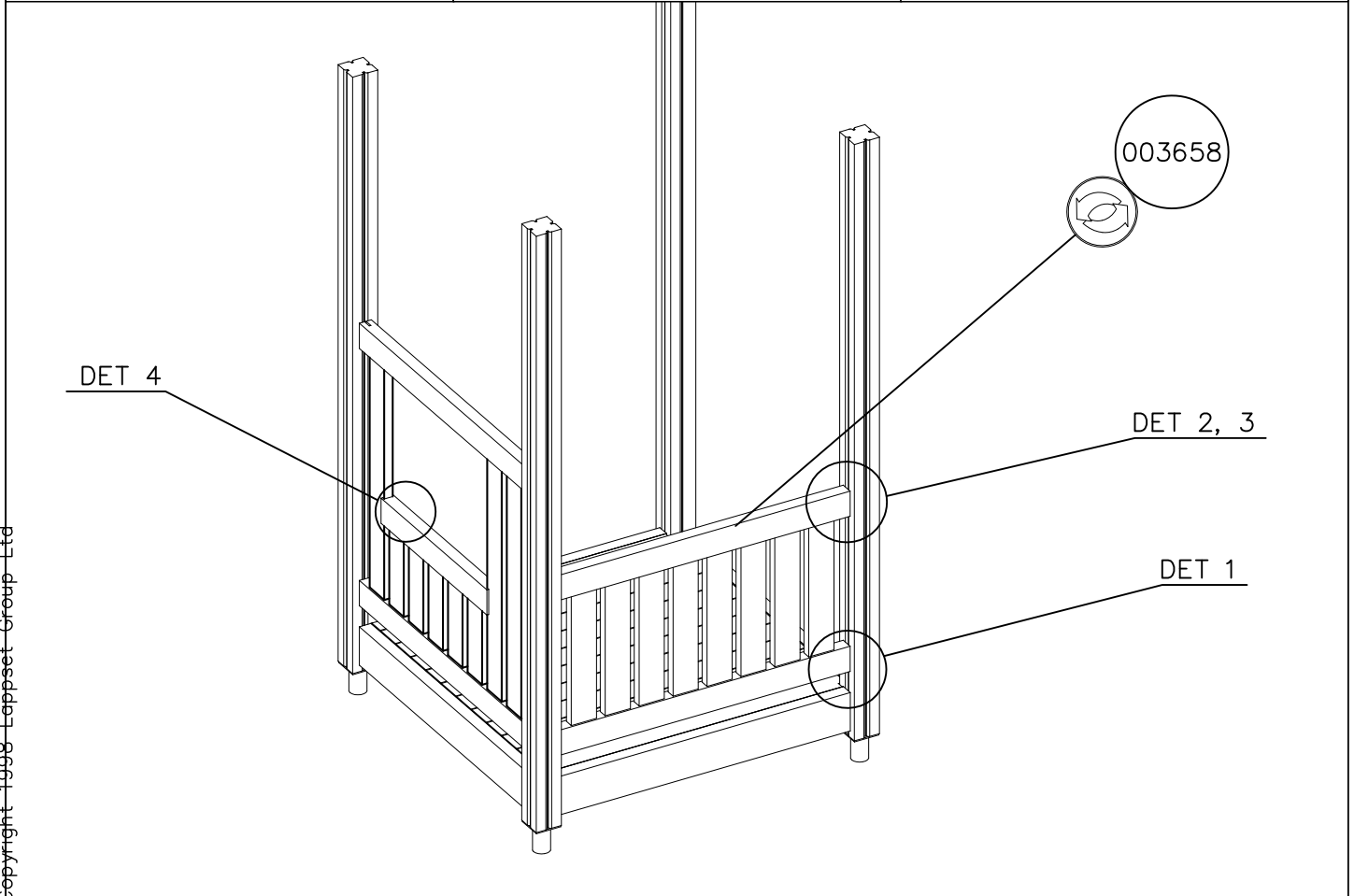
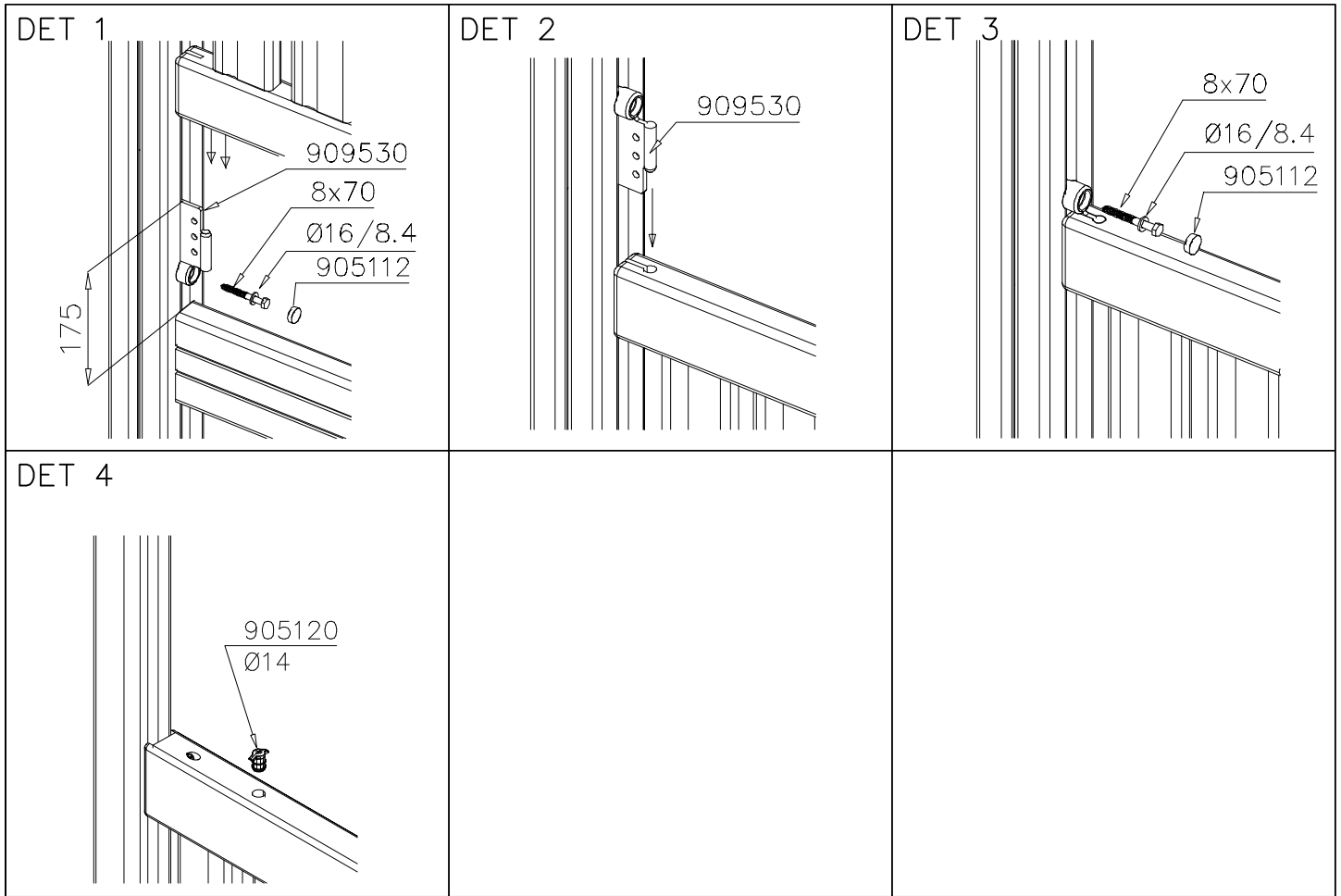

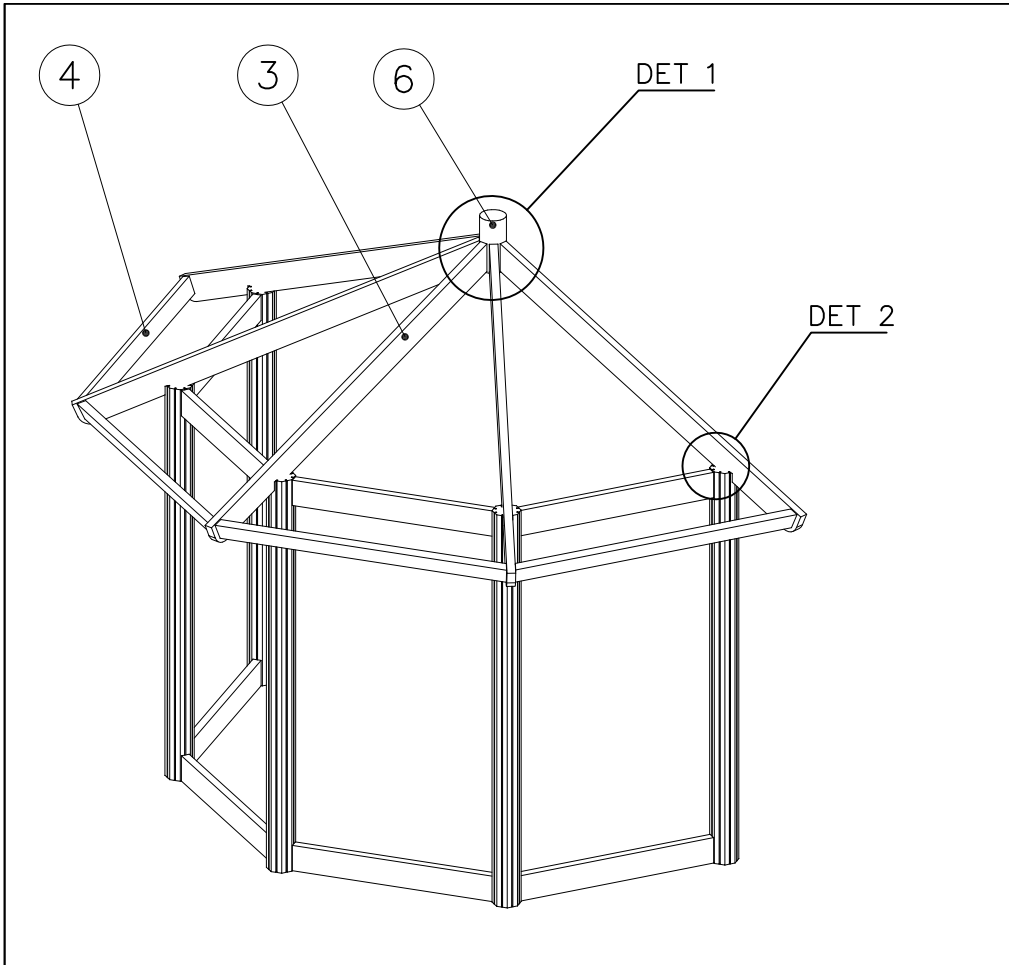

① 007493	PCS 4	② 007492	PCS 4
③ 007495	PCS 5	④ 007498	PCS 4
	L 2297		L 1610
⑤ 007496	PCS 5	⑥ 909666	PCS 1
	L 2330		
⑦ 007499	PCS 1	⑧ 905139	PCS 1
			BLACK

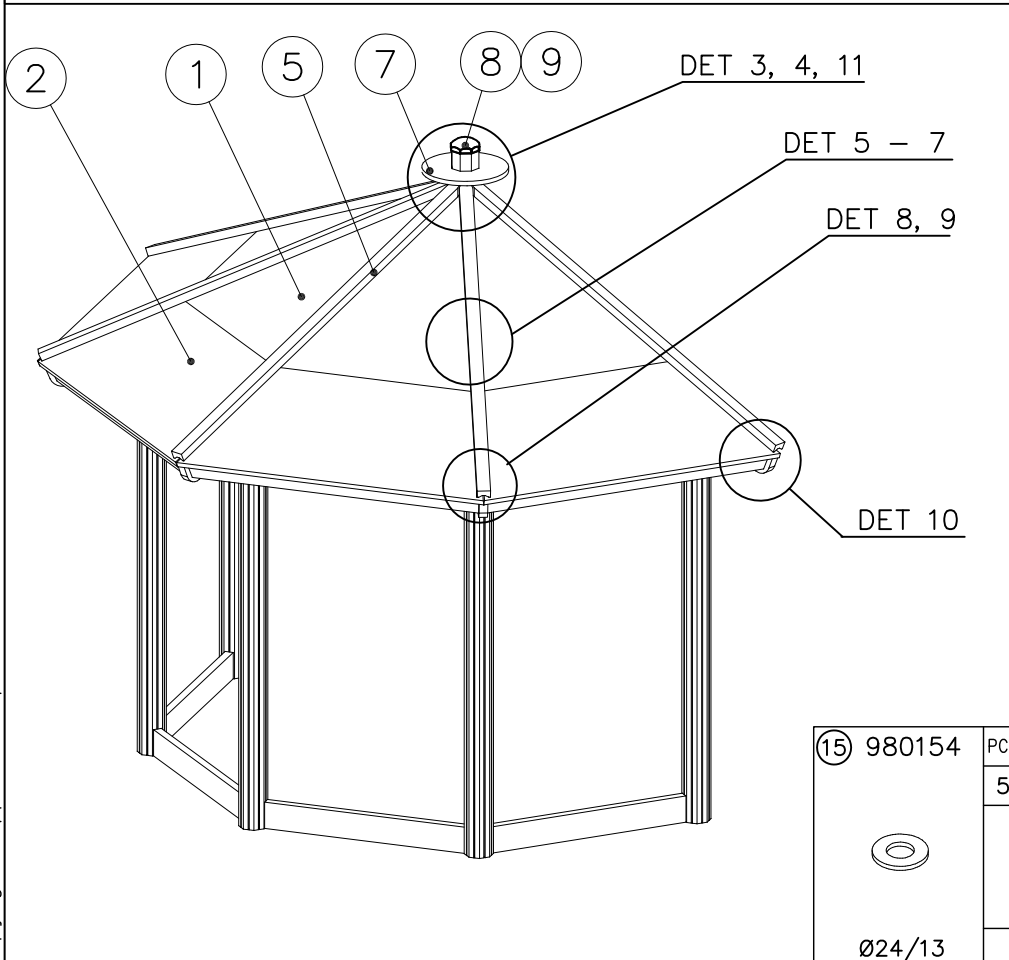

⑨ 905197	PCS 1	⑩ 909225	PCS 5
	BLACK		12x180
⑪ 980131	PCS 4	⑫ 908934	PCS 2
	6x60		165mm/ 10m
⑬ 980100	PCS 4	⑭ 980101	PCS 40
	5x60		4.5x70
⑮ 980154	PCS 5	⑯ 980104	PCS 8
	Ø24/13		5x90
		⑰ 980105	PCS 25
			5x120

<p>DET 1</p> <p>909666 7495 M10</p>	<p>DET 2</p> <p>Ø24/13 12x180 7495 7303</p>	<p>DET 3</p> <p>7499 909666</p>
<p>DET 4</p> <p>5x60</p>	<p>DET 5</p> <p>7493 4.5x70 7495</p>	<p>DET 6</p> <p>7493 7492</p>
<p>DET 7</p> <p>7492 4.5x70</p>	<p>DET 8</p> <p>908934</p>	<p>DET 9</p> <p>5x120 7496</p>
<p>DET 10</p> <p>7498 5x90</p>	<p>DET 11</p> <p>6x60</p>	