

# LAPPSET®

## PARKOUR

# Q17070

DATE: 7.3.2023

1(1)

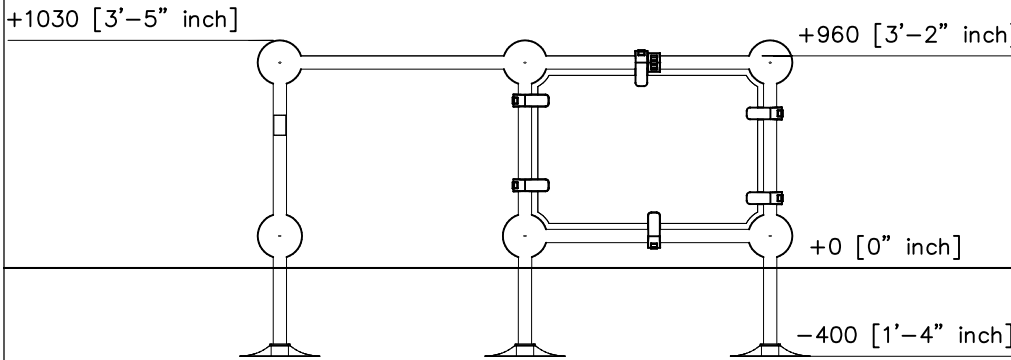
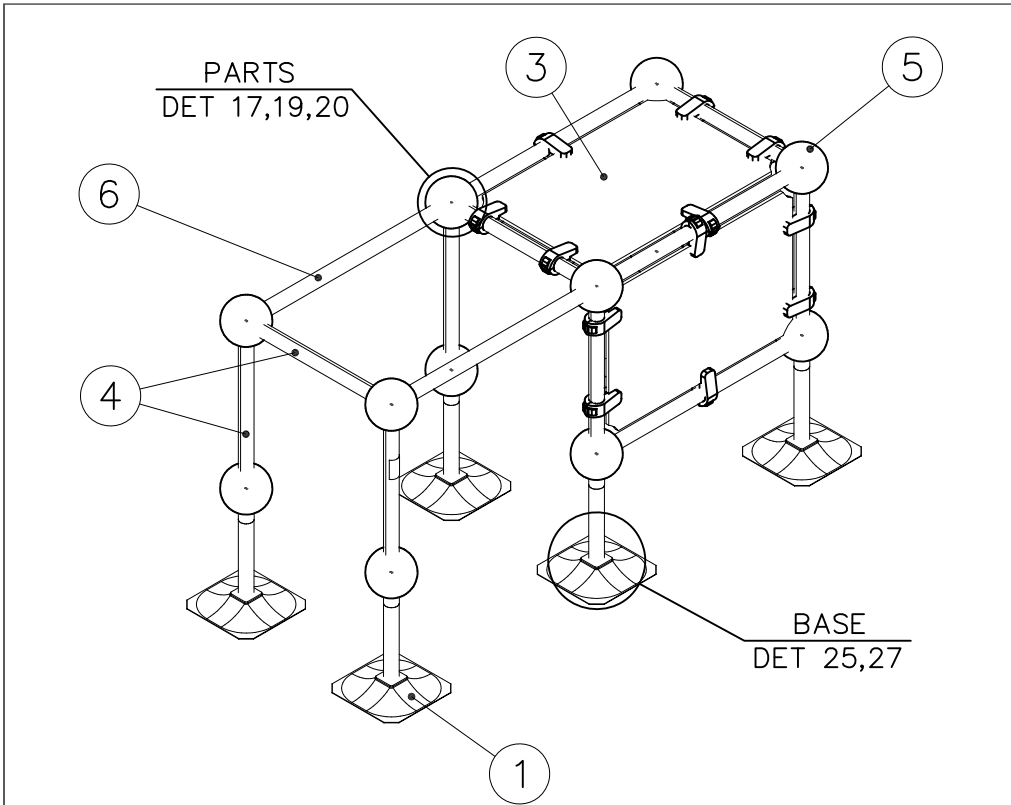

EN Impact Area 18.2 m<sup>2</sup> (196 sq ft)  
Max Falling Height 960 mm (3'-2" in)

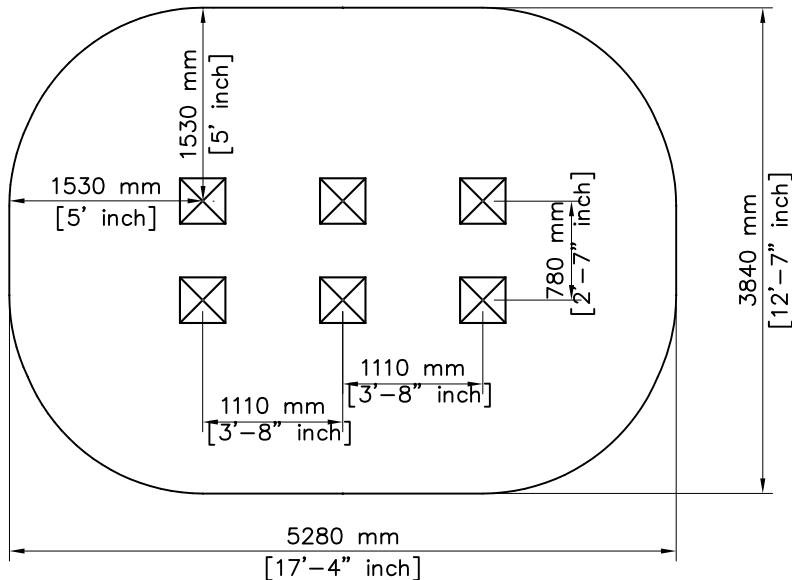

① 701985	PCS	② 702341	PCS
	6		1
		90x50	
③ 703486	PCS	④ 902022	PCS
	2		9
		L 710	
⑤ 902134	PCS	⑥ 902424	PCS
	12		5
		L 1034	
⑦ 902157	PCS		PCS
	40		
		60x60x2	
	PCS		PCS
	PCS		PCS
	PCS		PCS
	PCS		PCS

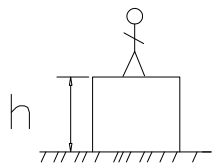

$h < 1000$

Totally hard surfaces or materials with very limited impact attenuating properties.

Totally hard surfaces.  
E.g. concrete or asphalt



Case by case risk assessment is needed including e.g. evaluation whether there is forced movement, what is the intended exercise and where will the product be installed.

Materials with very limited impact attenuating properties.  
E.g. wood



$h < 1200$

Materials with significant impact attenuating properties.

fine gravel 0–8 mm

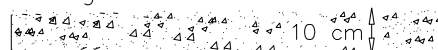

Unsorted sand/ topsoil

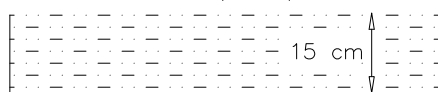

$h < 1500$

Lawn



$h < 3000$

Loose fill material

E.g.  
sand/gravel 0,25...8 mm  $D_{60}/D_{10} < 3,0$   
Woodchips 5...30 mm  
bark 20...80 mm

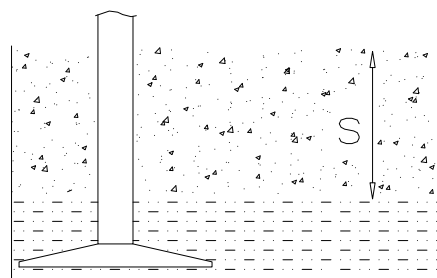

$\underline{S}$	$\underline{h}$
30 cm	$< 2,0$ m
40 cm	$< 3,0$ m



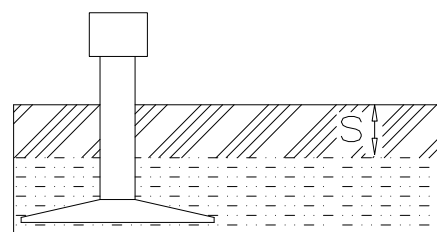

Syntetic granulates

$\underline{S}$	$\underline{h}$
40 mm	$\sim > 1,2...1,3$ m
50 mm	$\sim > 1,5...1,7$ m
60 mm	$\sim > 1,8...2,0$ m
70 mm	$\sim > 2,1...2,5$ m

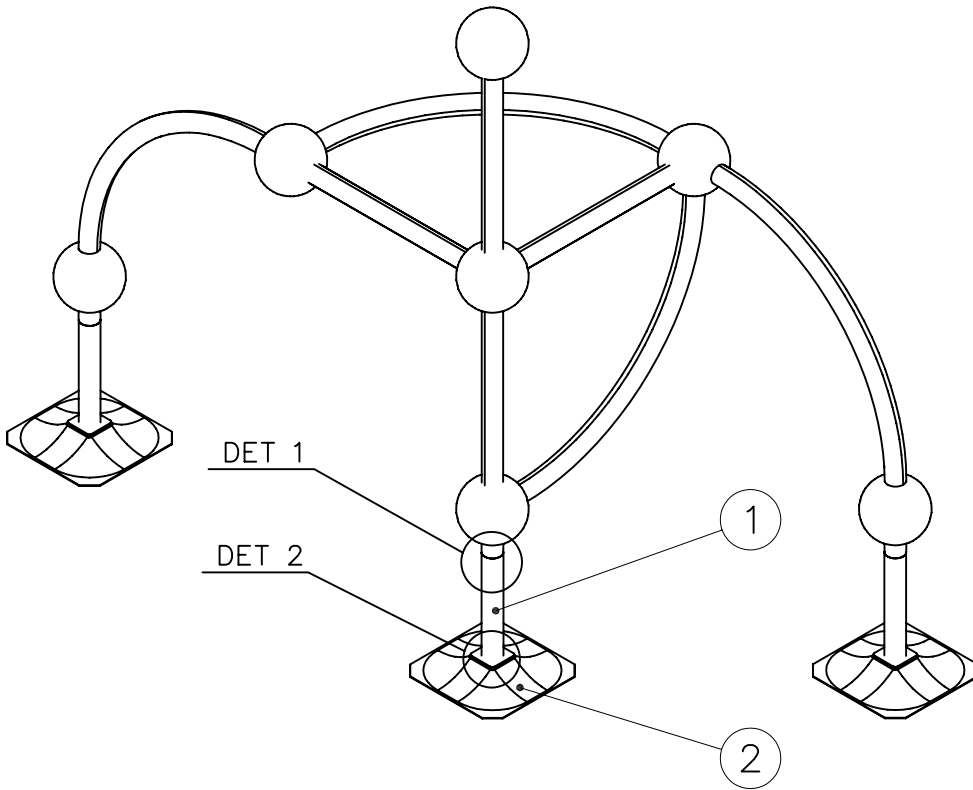

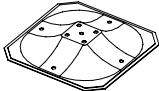
Note. For accurate values, see manufacturer's instructions.



① 902094	PCS	② 909519	PCS
	1		1
Ø60x450		50x380x380	
③ 909637	PCS	④ 909638	PCS
	4		4
M10		Ø20/10,5	
⑤ 909639	PCS		PCS
	4		
M10x25			
	PCS		PCS
	PCS		PCS
	PCS		PCS

DET 1

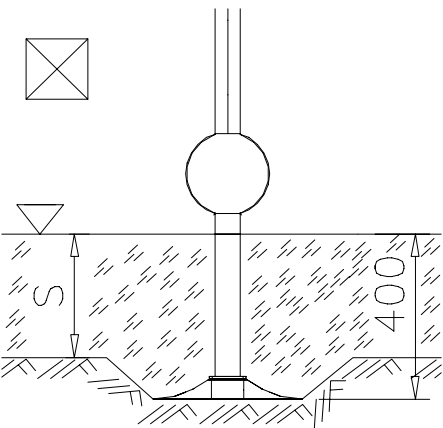

DET 2

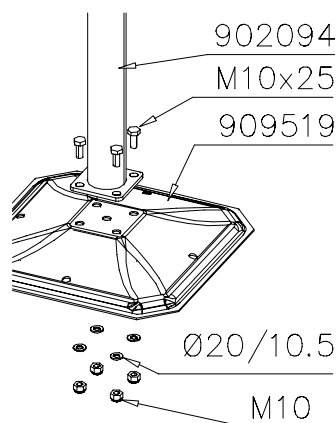

**Tuotekyltti tulee tuotteen mukana yhdellä seuraavista tavoista:****1) Metallinen tuotekyltti ja kiinnitysruuvit**

- Kiinnitä tuotekyltti ruuveilla tolppaan noin 2 metrin korkeuteen kuvan 1 mukaisesti.

**2) Tuotekylttitarra**

- Puhdista maalattu metalli- tai vaneripinta pölystä ja kosteudesta. Liimaa tarra kuvan 2 mukaisesti.
- Huom. Älä kiinnitä tarraa karheapintaiseen laminaattiin tai maalattuun puuhun.

**Vår produktmärkning levereras på ett av följande sätt:****1) Produktskylt i metall**

- Fäst skylten med de medföljande skruvarna

**2) Självhäftande produktetikett**

- Rengör den pulverlackerade metallytan eller laminatyten så att den blir fri från smuts och fukt. Fäst etiketten enligt fig. 2.
- Obs! Fäst ej etiketten på detaljer med skrovlig yta eller på målat trä.

**Product label is delivered by one of following ways:****1) Metal product label and screws**

- Fasten the label with screws.

**2) Label sticker**

- Clean the painted metal or plywood surface from dirt and moisture. Fasten the sticker as shown in the figure 2.
- Note. Do not attach the sticker to rough surfaced laminate or painted wood.

**La plaque d'informations produit est livrée sous l'une de ces 3 formes :****1) Plaque métallique et vis**

- Fixez la plaque à l'aide des vis.

**2) Etiquette autocollante**

- Avant de coller l'étiquette, nettoyez le composant métallique peint ou la plaque de contreplaqué, de toute saleté. La surface doit être sèche (voir image 2).
- Attention, ne pas coller l'étiquette sur une surface lamellé-collée irrégulière ou sur du bois peint.

**Die Auslieferung des Produktaufklebers erfolgt auf eine dieser Arten:****1) Produkt-Schild aus Metall incl. Schrauben**

- Die Befestigung des Schildes erfolgt mittels der Schrauben.

**2) Aufkleber**

- Entfernen Sie zunächst Schmutz und Feuchtigkeit vom lackierten Metall bzw. von der Holzoberfläche und bringen Sie den Aufkleber wie im Bild oben rechts beschrieben auf den gesäuberten Untergrund auf.
- Beachten Sie: Bringen Sie den Aufkleber nicht auf raues laminiertes oder lackiertes Holz an.

# LAPPSET®



## WALL

# PARKOUR

DATE: 17.11.2010

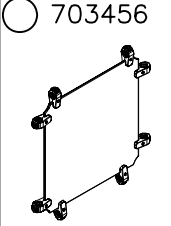
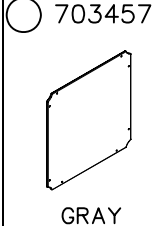
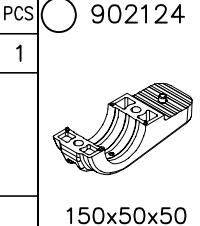
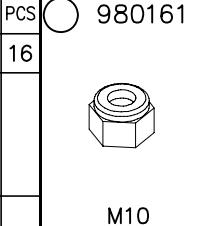
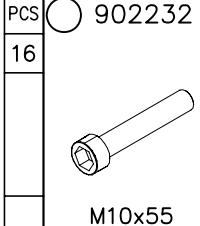
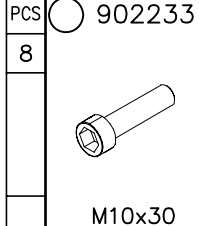
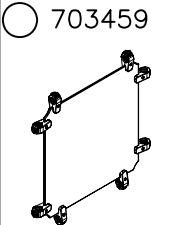
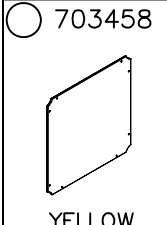
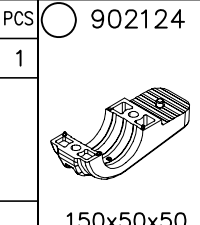
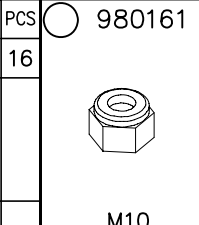
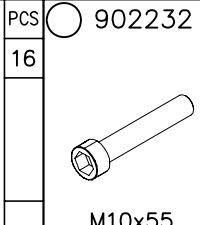
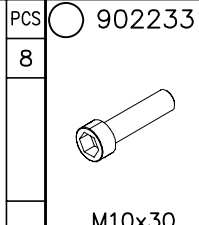
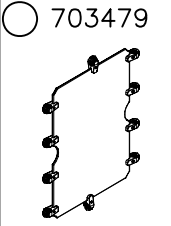
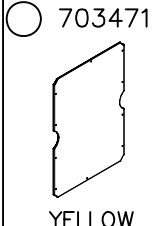
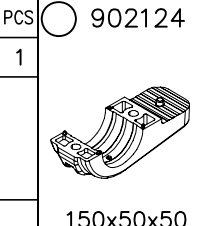
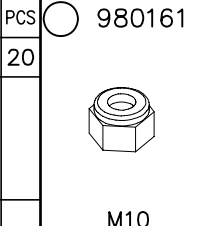
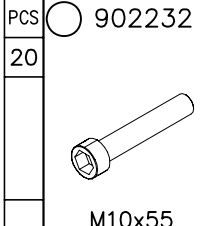
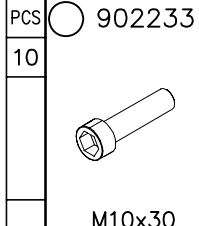
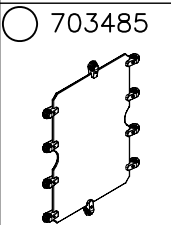
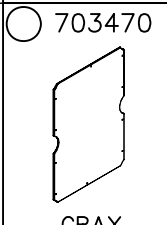
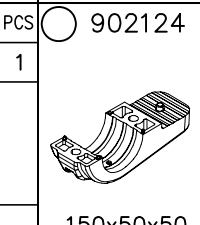
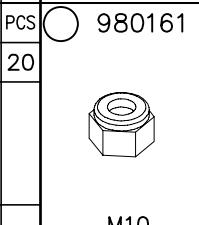
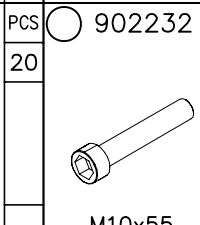
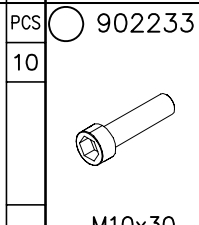
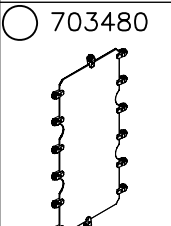
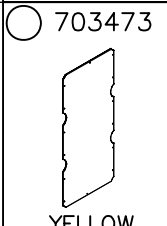
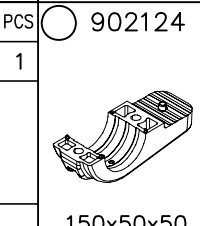
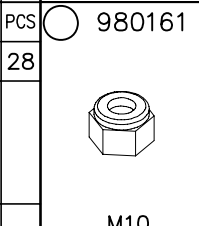
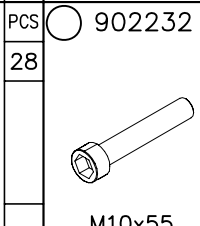
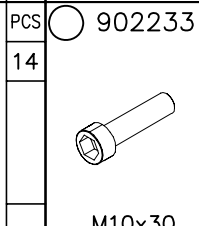
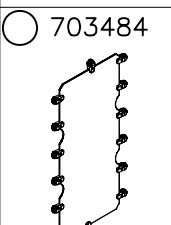
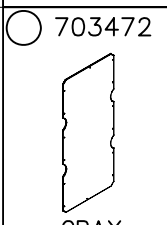
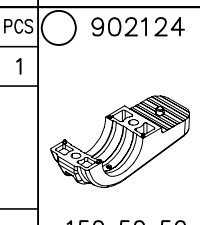
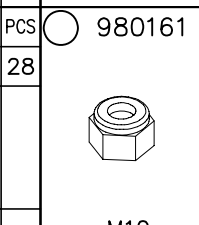
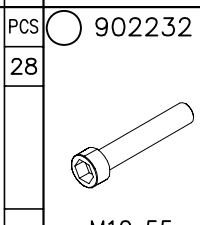
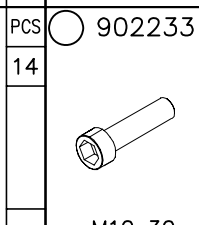
1(2)

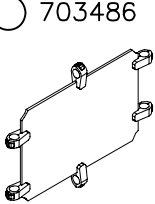
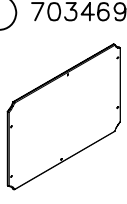
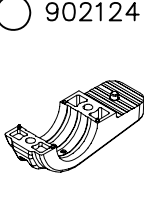
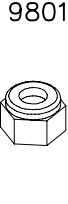
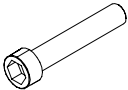
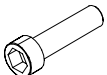
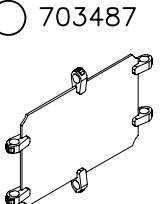
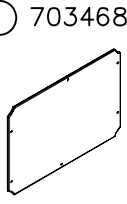
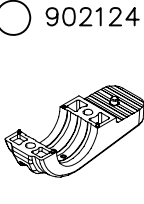
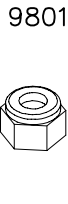
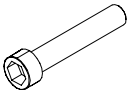
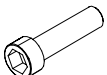
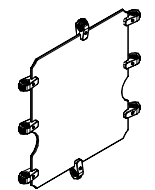
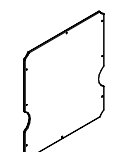
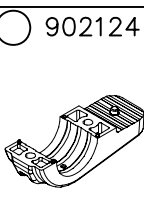
	 GRAY	PCS 1	 150x50x50	PCS 16	 M10	PCS 16	 M10x55	PCS 8	 M10x30	PCS 8		PCS
	 YELLOW	PCS 1	 150x50x50	PCS 16	 M10	PCS 16	 M10x55	PCS 8	 M10x30	PCS 8		PCS
		PCS		PCS		PCS		PCS		PCS		PCS
	 YELLOW	PCS 1	 150x50x50	PCS 20	 M10	PCS 20	 M10x55	PCS 10	 M10x30	PCS 10		PCS
	 GRAY	PCS 1	 150x50x50	PCS 20	 M10	PCS 20	 M10x55	PCS 10	 M10x30	PCS 10		PCS
		PCS		PCS		PCS		PCS		PCS		PCS
	 YELLOW	PCS 1	 150x50x50	PCS 28	 M10	PCS 28	 M10x55	PCS 14	 M10x30	PCS 14		PCS
	 GRAY	PCS 1	 150x50x50	PCS 28	 M10	PCS 28	 M10x55	PCS 14	 M10x30	PCS 14		PCS

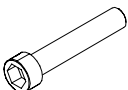
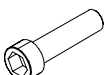
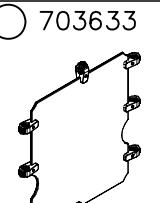
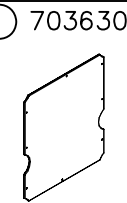
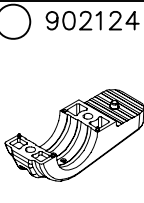
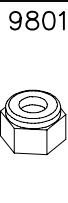
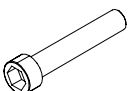
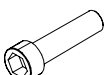
 <p>703486</p>	 <p>703469 YELLOW</p>	<p>PCS</p> <p>1</p>	 <p>902124</p> <p>150x50x50</p>	<p>PCS</p> <p>12</p>	 <p>980161</p> <p>M10</p>	<p>PCS</p> <p>12</p>	 <p>902232</p> <p>M10x55</p>	<p>PCS</p> <p>6</p>	 <p>902233</p> <p>M10x30</p>	<p>PCS</p> <p>6</p>		<p>PCS</p>
 <p>703487</p>	 <p>703468 GRAY</p>	<p>PCS</p> <p>1</p>	 <p>902124</p> <p>150x50x50</p>	<p>PCS</p> <p>12</p>	 <p>980161</p> <p>M10</p>	<p>PCS</p> <p>12</p>	 <p>902232</p> <p>M10x55</p>	<p>PCS</p> <p>6</p>	 <p>902233</p> <p>M10x30</p>	<p>PCS</p> <p>6</p>		<p>PCS</p>
		<p>PCS</p>		<p>PCS</p>		<p>PCS</p>		<p>PCS</p>		<p>PCS</p>		<p>PCS</p>
 <p>703632</p>	 <p>703631 YELLOW</p>	<p>PCS</p> <p>1</p>	 <p>902124</p> <p>150x50x50</p>	<p>PCS</p> <p>16</p>	 <p>980161</p> <p>M10</p>	<p>PCS</p> <p>16</p>	 <p>902232</p> <p>M10x55</p>	<p>PCS</p> <p>8</p>	 <p>902233</p> <p>M10x30</p>	<p>PCS</p> <p>8</p>		<p>PCS</p>
 <p>703633</p>	 <p>703630 GRAY</p>	<p>PCS</p> <p>1</p>	 <p>902124</p> <p>150x50x50</p>	<p>PCS</p> <p>16</p>	 <p>980161</p> <p>M10</p>	<p>PCS</p> <p>16</p>	 <p>902232</p> <p>M10x55</p>	<p>PCS</p> <p>8</p>	 <p>902233</p> <p>M10x30</p>	<p>PCS</p> <p>8</p>		<p>PCS</p>
		<p>PCS</p>		<p>PCS</p>		<p>PCS</p>		<p>PCS</p>		<p>PCS</p>		<p>PCS</p>

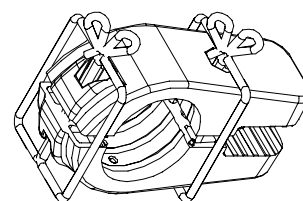
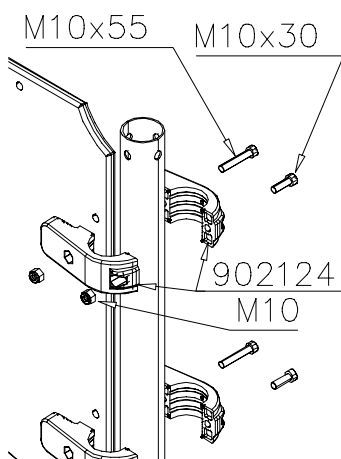
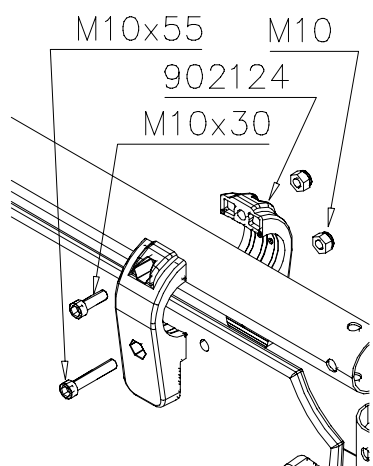



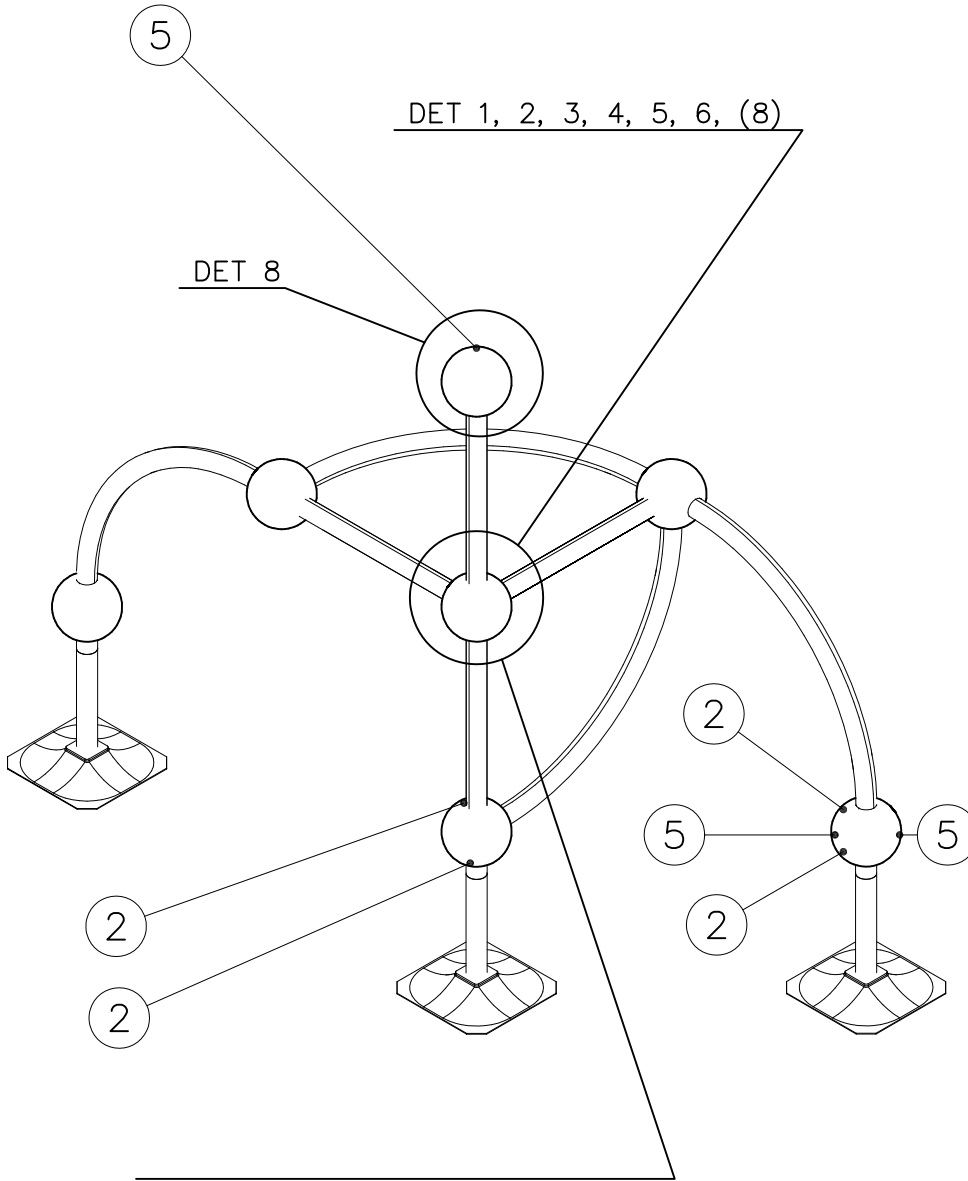

NOTE:  
Use a wire marked pairs  
of the same junction.

Huom!  
Käytä langalla merkittyä  
paria samassa liitoksessa.

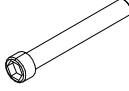

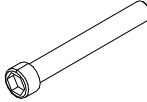
DO NOT TIGHTEN THE JOINTS UNTIL THE STRUCTURE IS COMPLETE.

① 901803	PCS	② 901994	PCS
	2		2
M12x90		Ø190	
③ 902096	PCS	④ 902234	PCS
	4		6
M12x120		M12	
	PCS		PCS
	PCS		PCS
	PCS		PCS
	PCS		PCS
	PCS		PCS
	PCS		PCS

DET 1

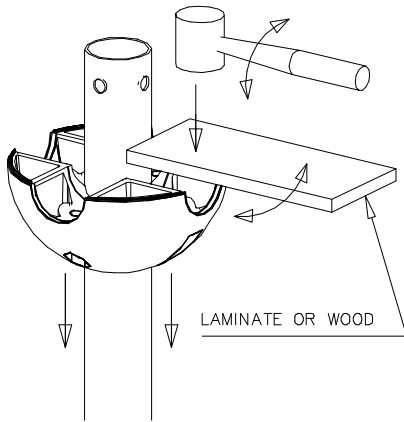

DET 2

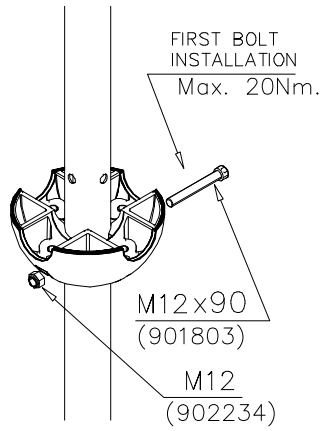

DET 3

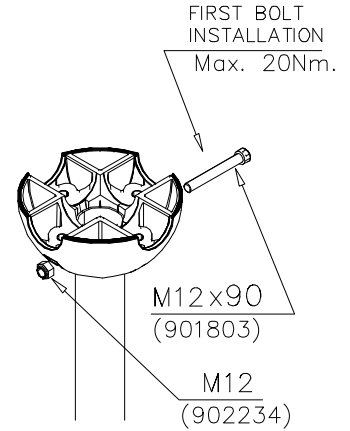

DET 4

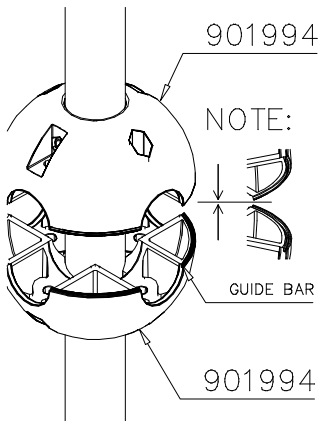

DET 5

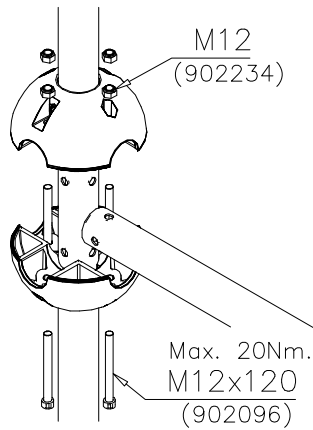

DET 6

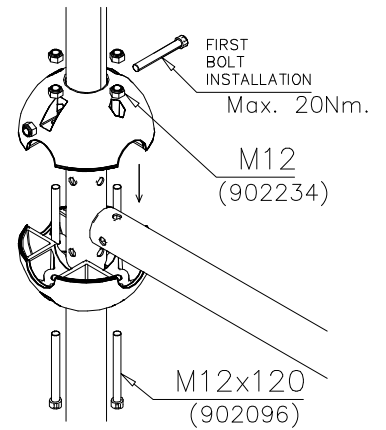

REMEMBER  
FINAL  
TIGHTENING

DET 7

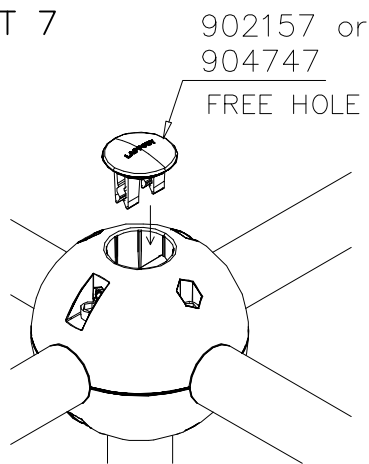

DET 8

