

LAPPSET®

FINNO











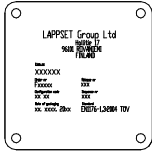
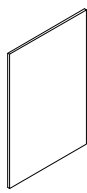



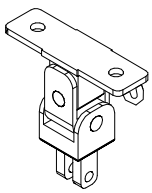

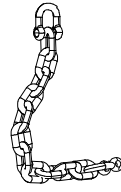
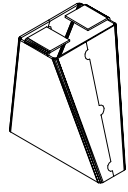

ASENNUSOHJE
MONTERINGSANSVISNING
INSTALLATION INSTRUCTION
AUFBAUANLEITUNG
NOTICE D'INSTALLATION

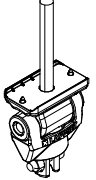
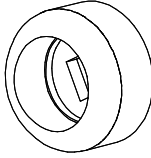
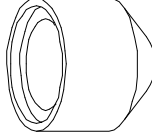
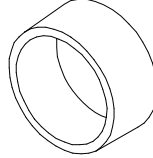
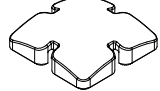
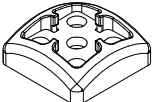
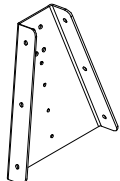
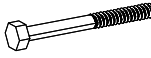
DATE: 7.5.2020

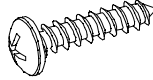
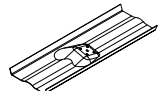
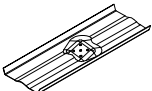
Q10786-2

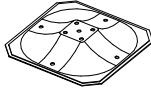
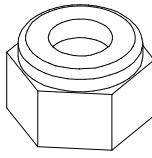
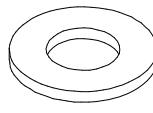
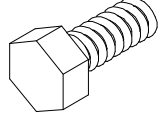
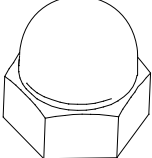

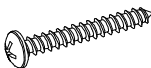
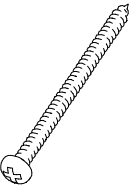
DATE: 7.5.2020

702286  65x65	PCS 1	702533  118x78	PCS 1	703248 	PCS 1	706564  L2650	PCS 8	900965  M10	PCS 12	901958 	PCS 2
901959  L2940	PCS 1	902234  M12	PCS 4	903149  M12x30	PCS 12	903577 	PCS 2	904317 	PCS 2	904333  L2940	PCS 2
904904 	PCS 8	905090  Ø45	PCS 24	905104  M10	PCS 32	905115  Ø30	PCS 24	905138 	PCS 8	905196 	PCS 8
905991 	PCS 2	906499  M12x110	PCS 4	909347  M12x35	PCS 24	909506  Ø3.5x13	PCS 4	909507  L 1000	PCS 2	909508  L 1000	PCS 2
909511  L650	PCS 4	909519  50x380x380	PCS 4	909637  M10	PCS 32	909638  Ø20/10.5	PCS 88	909639  M10x25	PCS 44	909644  M12	PCS 12
911155  L650	PCS 4	980114  Ø4x20	PCS 4	980131  Ø6x60	PCS 32	980154  Ø24x13	PCS 56	999561  GLUE 4101 ergo 10 g 10g	PCS 1		PCS
	PCS		PCS		PCS		PCS		PCS		PCS

- EN/AS Impact Area 67.1 m²
- Falling Space 67.1 m²
Max Falling Height 1400 mm

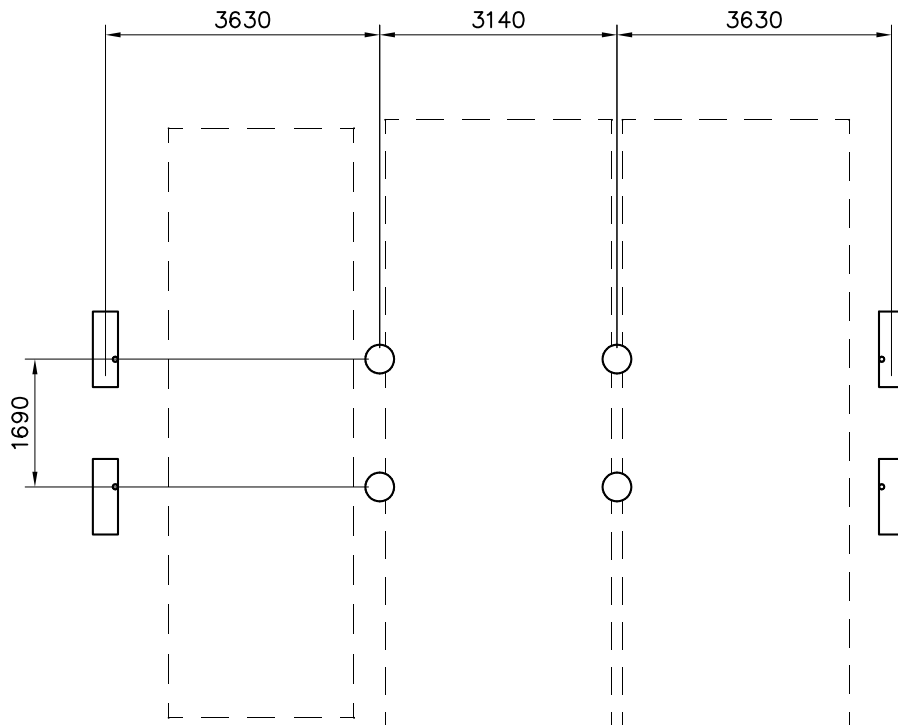

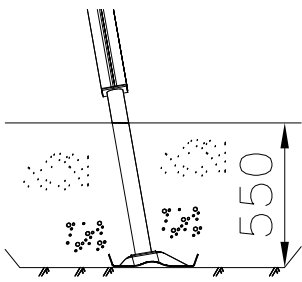
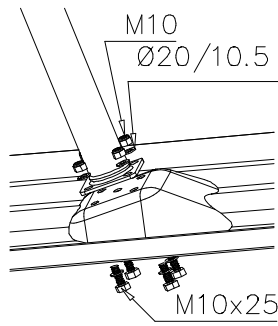
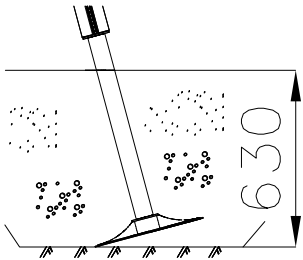
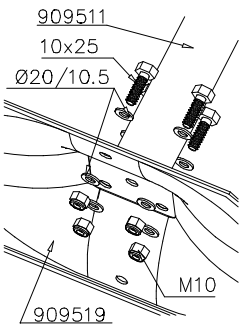

—— EN/AS Impact Area 67.1 m²
 - - - - Falling Space 67.1 m²
 Max Falling Height 1400 mm

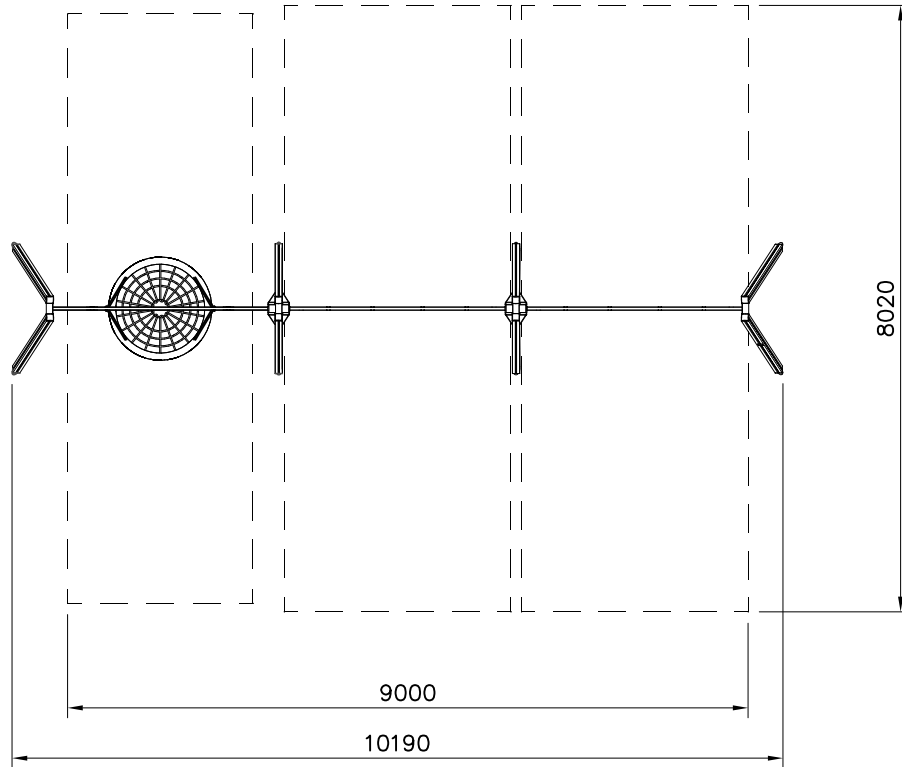
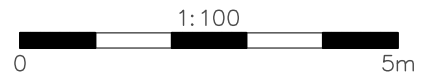

Copyright Lappset Group Ltd

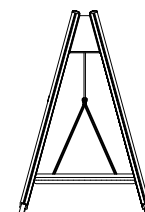
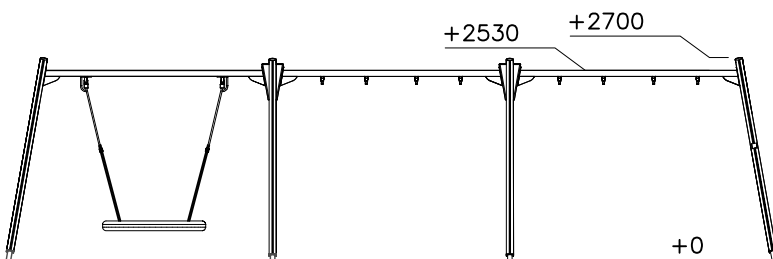

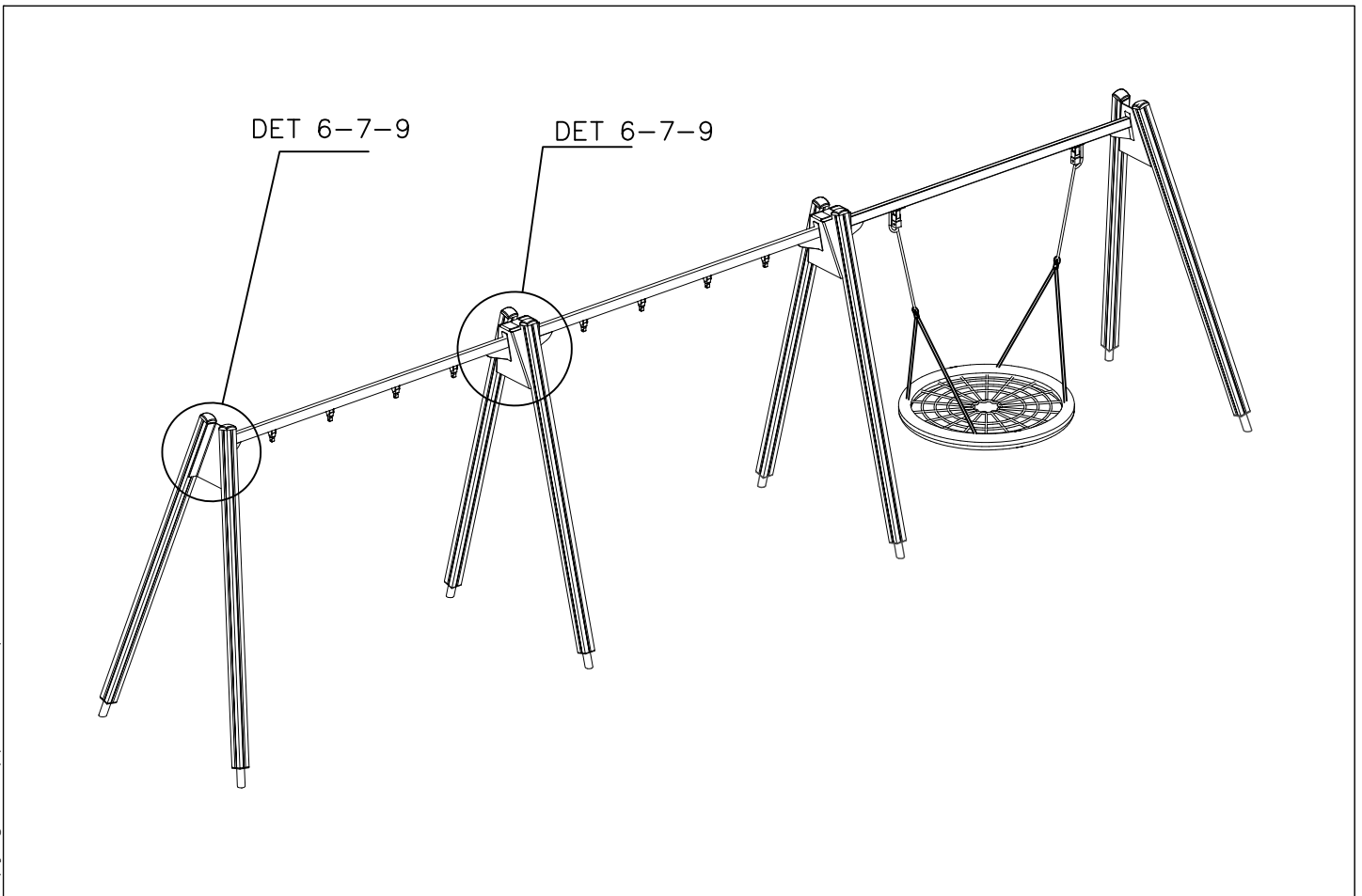
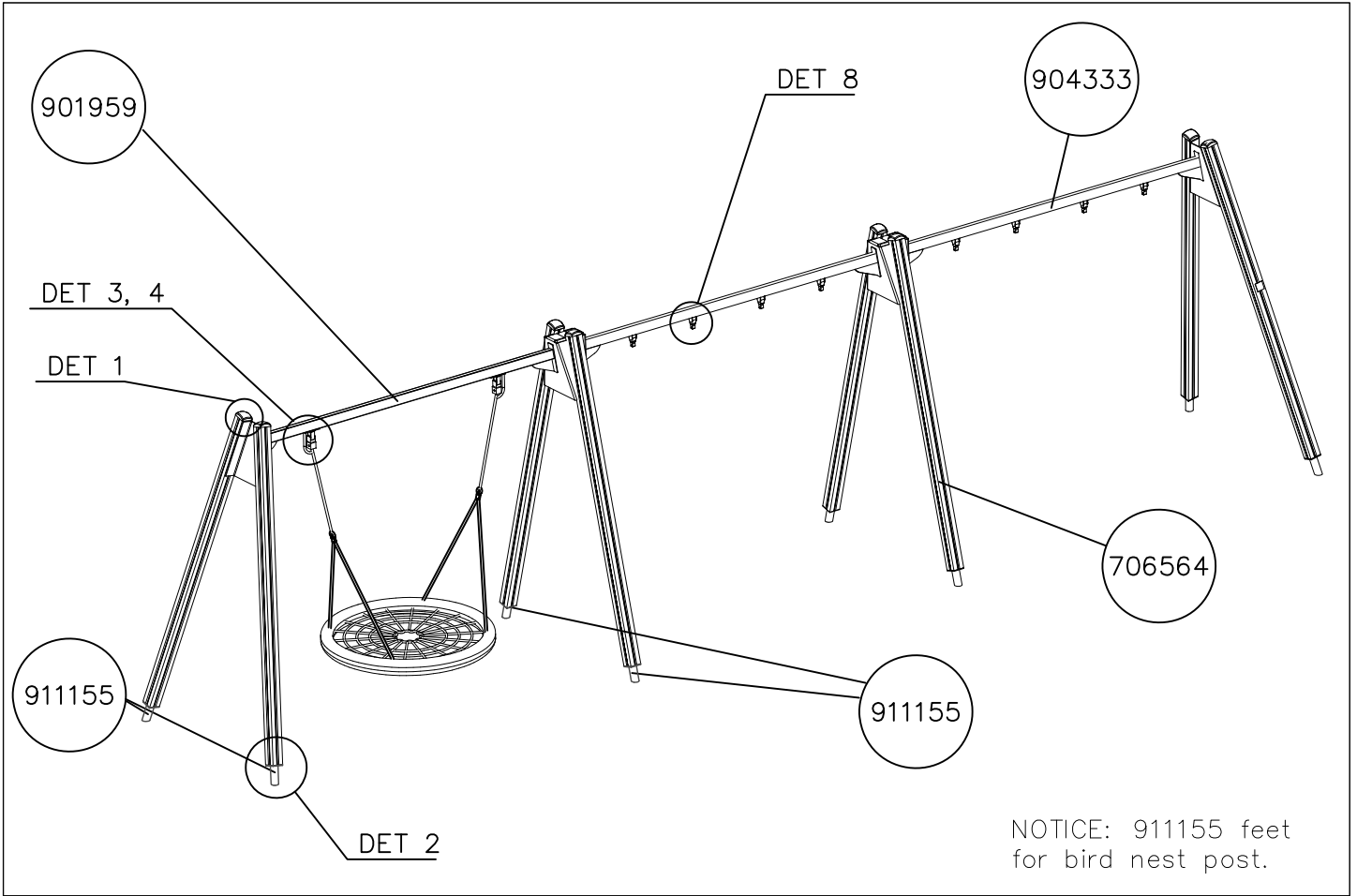

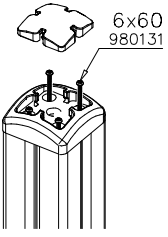
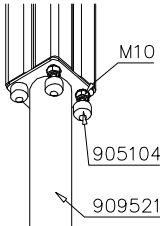
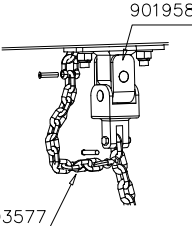
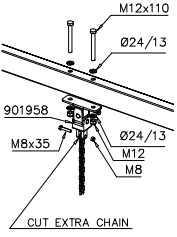
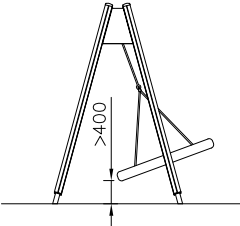
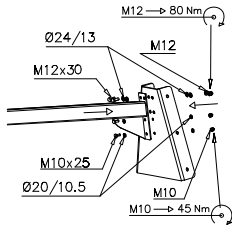
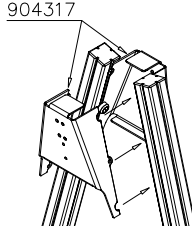
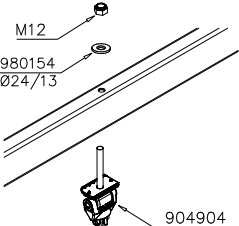
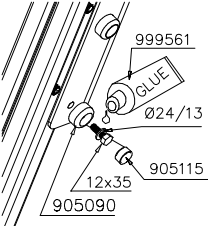
<p>DET 1</p> 	<p>DET 2</p>  <p>NOTICE: 911155 feet for bird nest post.</p>	<p>DET 3</p> 	<p>DET 4</p> 
<p>DET 5</p> 	<p>DET 6</p> 	<p>DET 7</p> 	<p>DET 8</p> 
<p>DET 9</p> 			

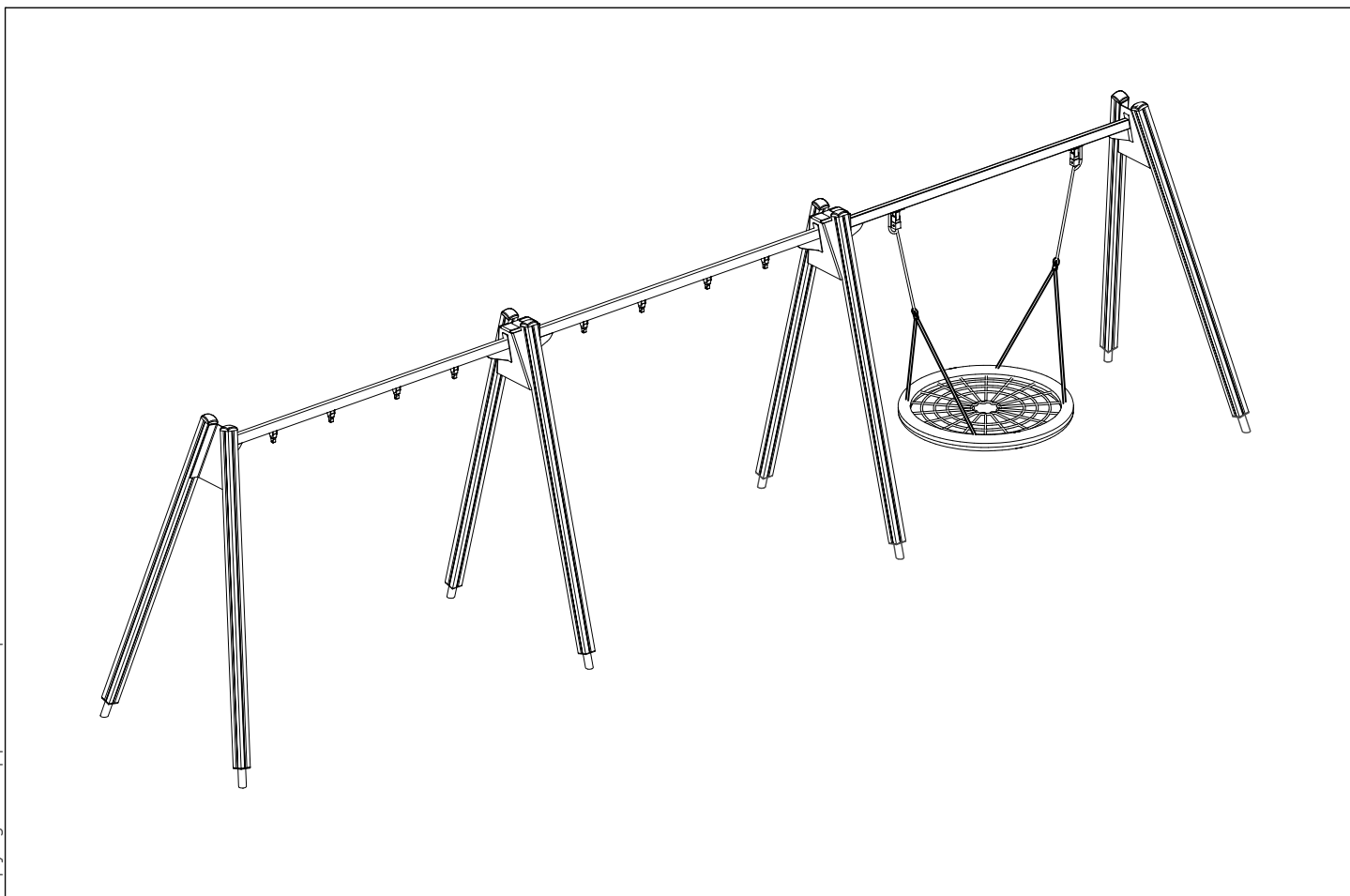

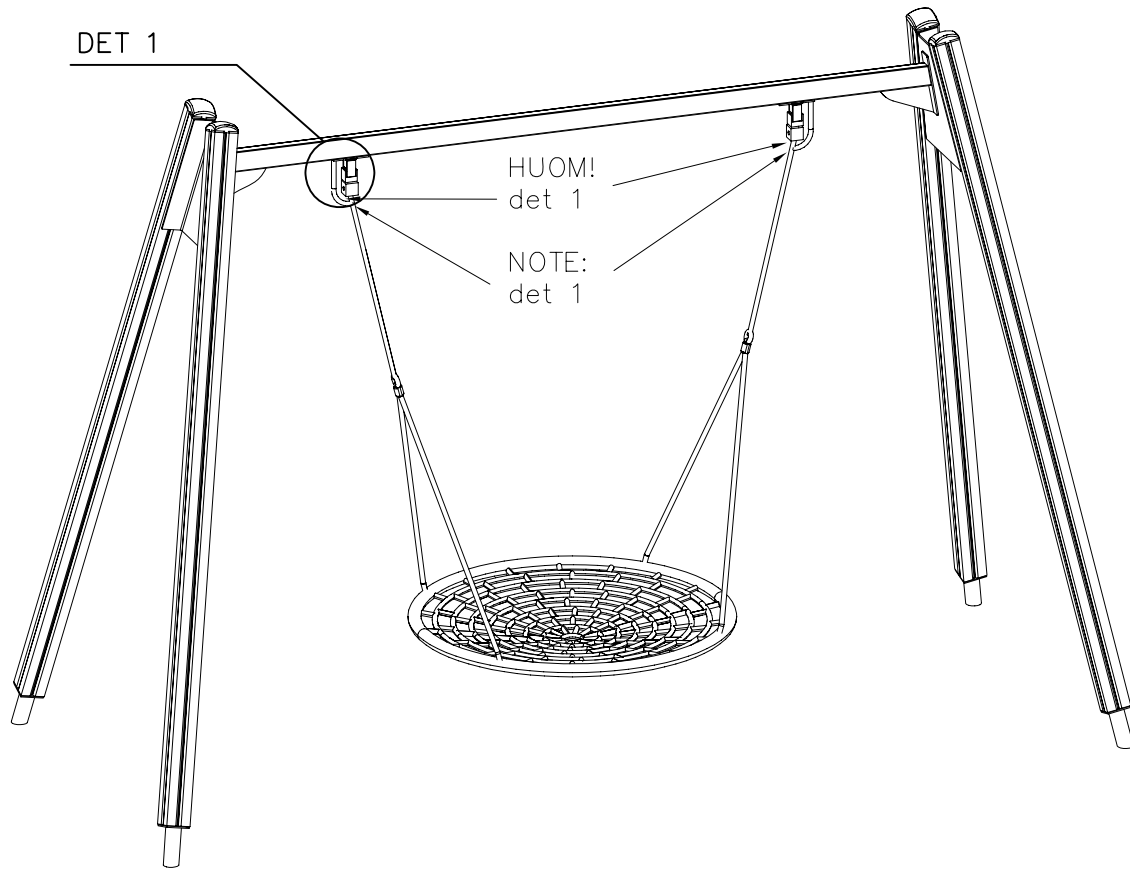

DET 1

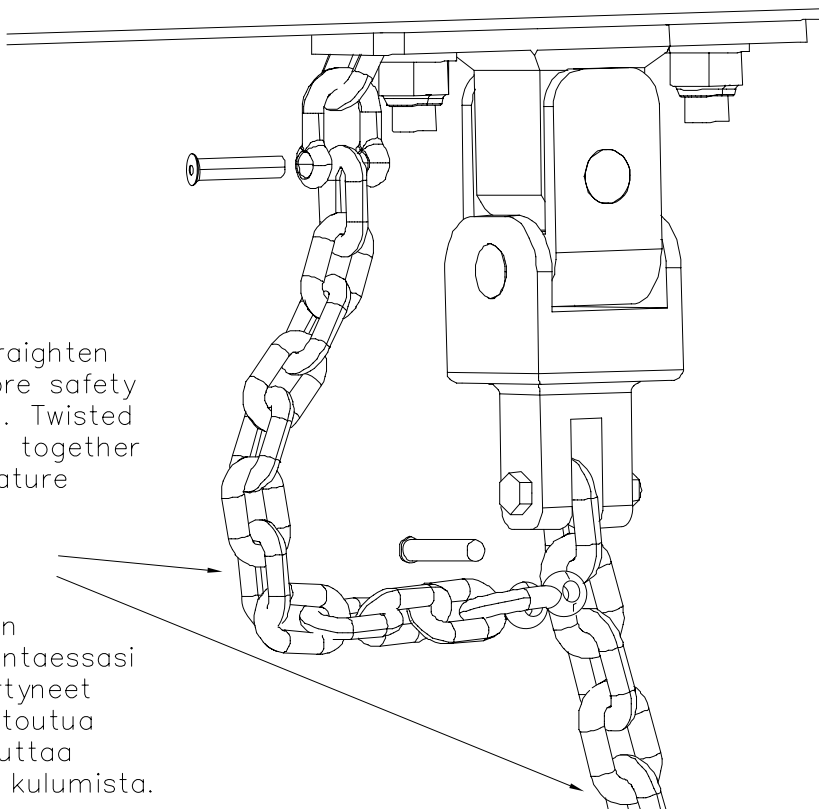

LAPPSET®
BETON FOUNDATION

FOOT

DATE: 27.10.2015

1(1)

② 905104	PCS		PCS
	4		
 M10	PCS		PCS



905104

**Tuotekyltti tulee tuotteen mukana yhdellä seuraavista tavoista:****1) Metallinen tuotekyltti ja kiinnitysruuvit**

- Kiinnitä tuotekyltti ruuveilla tolppaan noin 2 metrin korkeuteen kuvan 1 mukaisesti.

2) Tuotekylttitarra

- Puhdista maalattu metalli- tai vaneripinta pölystä ja kosteudesta. Liimaa tarra kuvan 2 mukaisesti.
- Huom. Älä kiinnitä tarraa karheapintaiseen laminaattiin tai maalattuun puuhun.

Vår produktmärkning levereras på ett av följande sätt:**1) Produktskylt i metall**

- Fäst skylten med de medföljande skruvarna

2) Självhäftande produktetikett

- Rengör den pulverlackerade metallytan eller laminatyten så att den blir fri från smuts och fukt. Fäst etiketten enligt fig. 2.
- Obs! Fäst ej etiketten på detaljer med skrovlig yta eller på målat trä.

Product label is delivered by one of following ways:**1) Metal product label and screws**

- Fasten the label with screws.

2) Label sticker

- Clean the painted metal or plywood surface from dirt and moisture. Fasten the sticker as shown in the figure 2.
- Note. Do not attach the sticker to rough surfaced laminate or painted wood.

La plaque d'informations produit est livrée sous l'une de ces 3 formes :**1) Plaque métallique et vis**

- Fixez la plaque à l'aide des vis.

2) Etiquette autocollante

- Avant de coller l'étiquette, nettoyez le composant métallique peint ou la plaque de contreplaqué, de toute saleté. La surface doit être sèche (voir image 2).
- Attention, ne pas coller l'étiquette sur une surface lamellé-collée irrégulière ou sur du bois peint.

Die Auslieferung des Produktaufklebers erfolgt auf eine dieser Arten:**1) Produkt-Schild aus Metall incl. Schrauben**

- Die Befestigung des Schildes erfolgt mittels der Schrauben.

2) Aufkleber

- Entfernen Sie zunächst Schmutz und Feuchtigkeit vom lackierten Metall bzw. von der Holzoberfläche und bringen Sie den Aufkleber wie im Bild oben rechts beschrieben auf den gesäuberten Untergrund auf.
- Beachten Sie: Bringen Sie den Aufkleber nicht auf raues laminiertes oder lackiertes Holz an.