

LAPPSET®

CLOVER





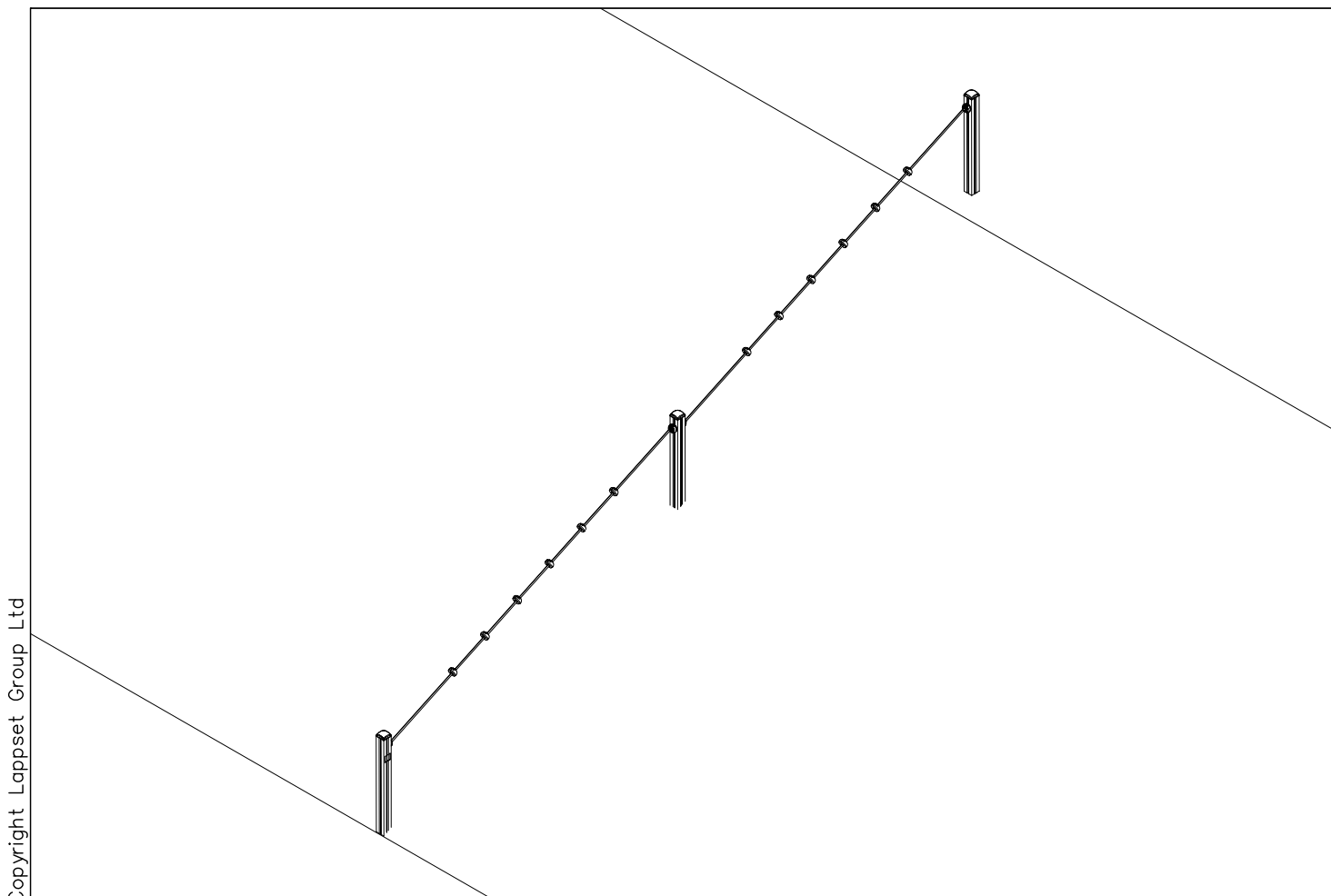

ASENNUSOHJE
MONTERINGSANSVISNING
INSTALLATION INSTRUCTION
AUFBAUANLEITUNG
NOTICE D'INSTALLATION

DATE: 23.3.2017

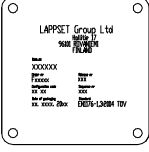
Q11416

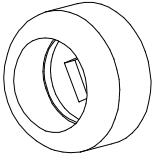
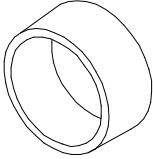
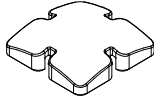
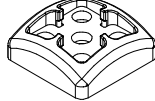

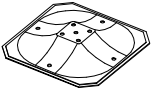
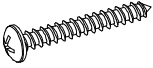
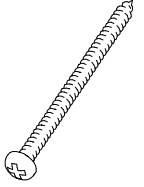
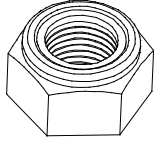
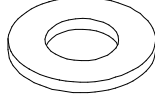
DATE: 28.5.2019

702286  65x65	PCS 1	706527  93x93x1600	PCS 3	905083  Ø32	PCS 8	905112  Ø22	PCS 8	905138  GRAY	PCS 3	905196  GRAY	PCS 3
906503  M8x120	PCS 8	909519  50x380x380	PCS 3	980114  Ø4x20	PCS 4	980131  Ø6x60	PCS 12	980150  M8	PCS 8	980151  Ø16/8.4	PCS 8
P07518  L 4000	PCS 2		PCS		PCS		PCS		PCS		PCS
	PCS		PCS		PCS		PCS		PCS		PCS
	PCS		PCS		PCS		PCS		PCS		PCS
	PCS		PCS		PCS		PCS		PCS		PCS
	PCS		PCS		PCS		PCS		PCS		PCS

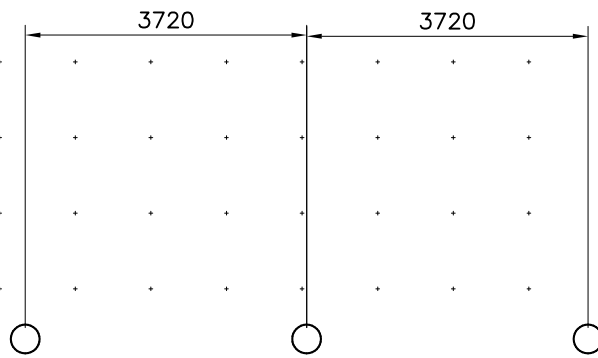
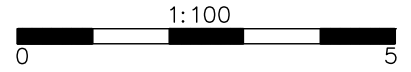

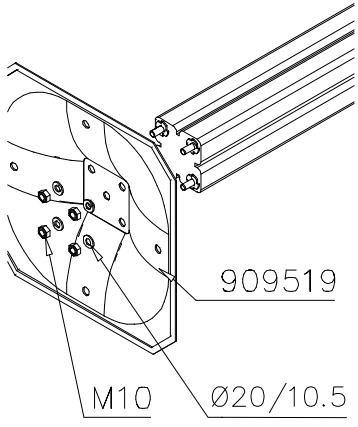
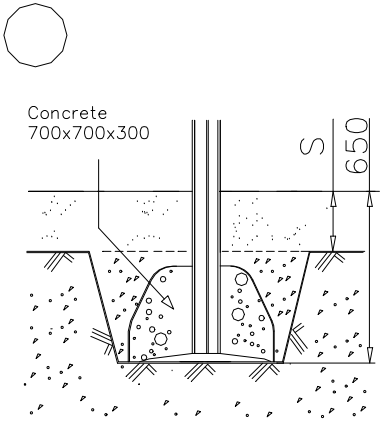
 <p>909519</p> <p>M10 Ø20/10.5</p>	 <p>Concrete 700x700x300</p> <p>650</p>	

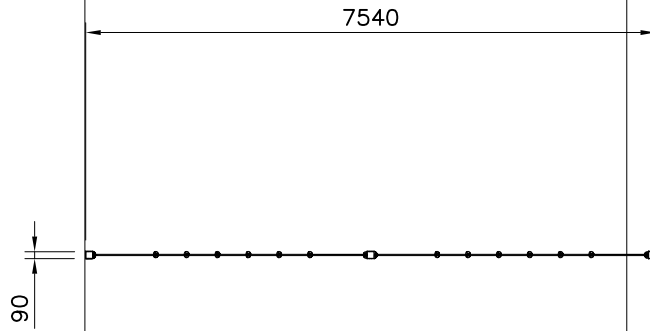
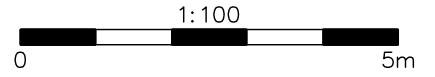

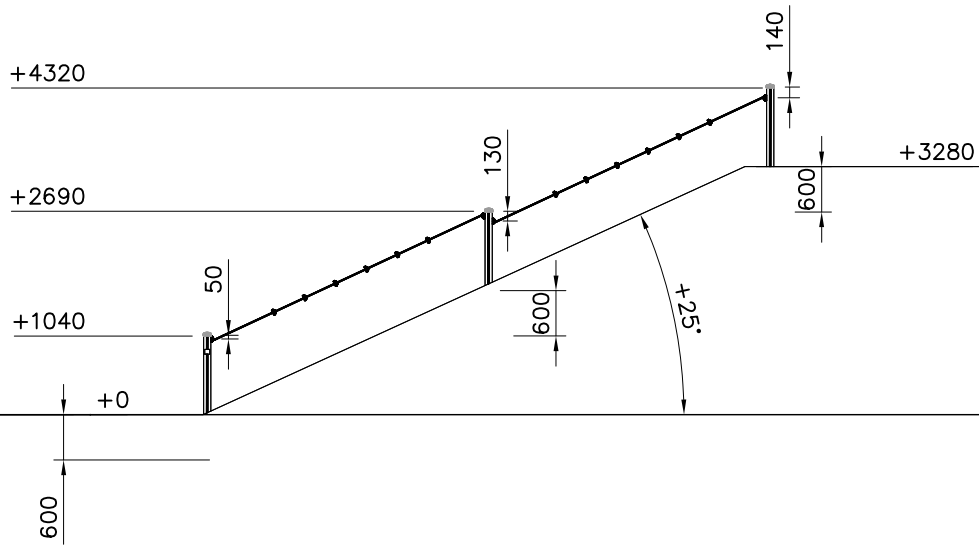

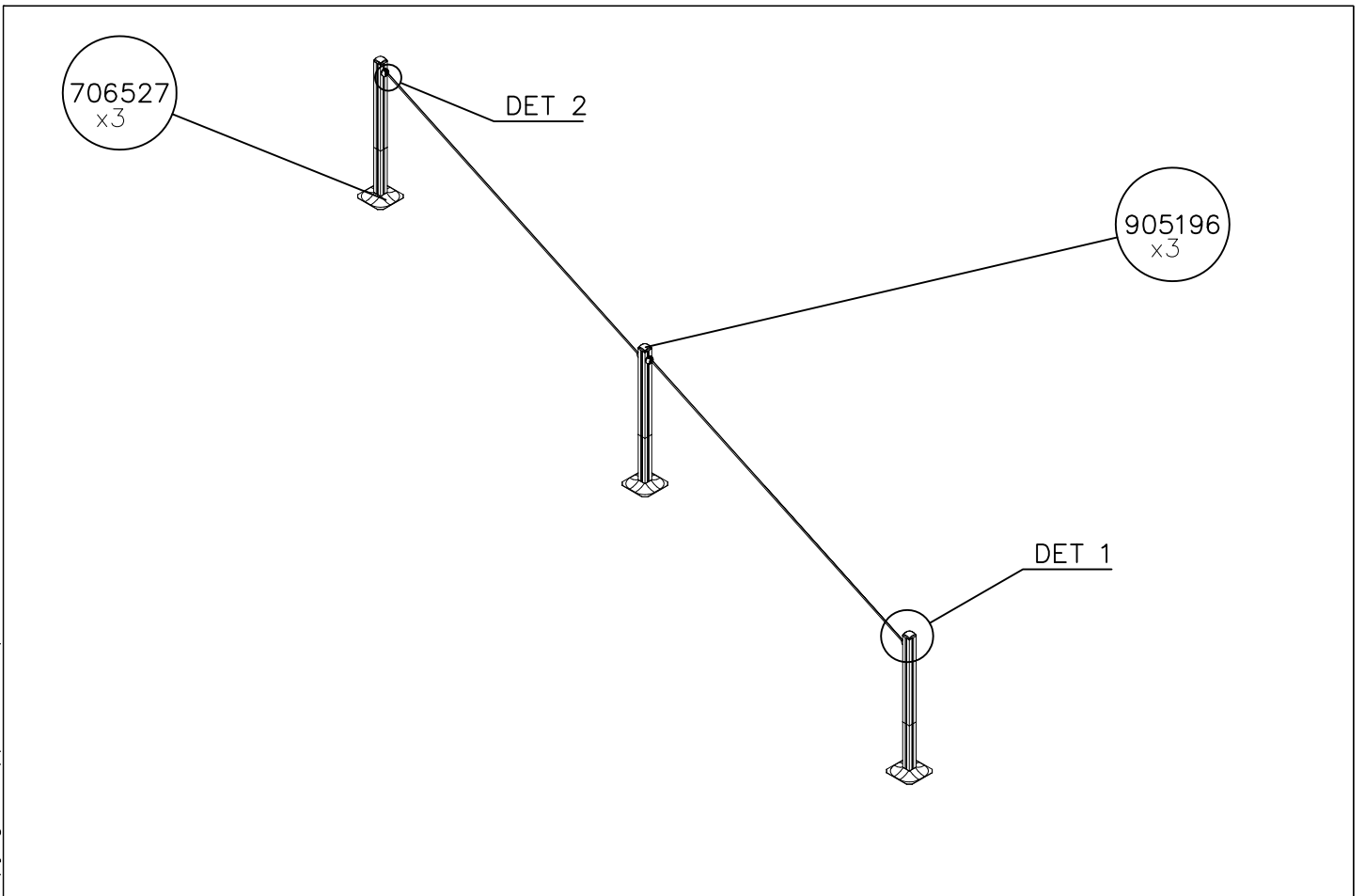
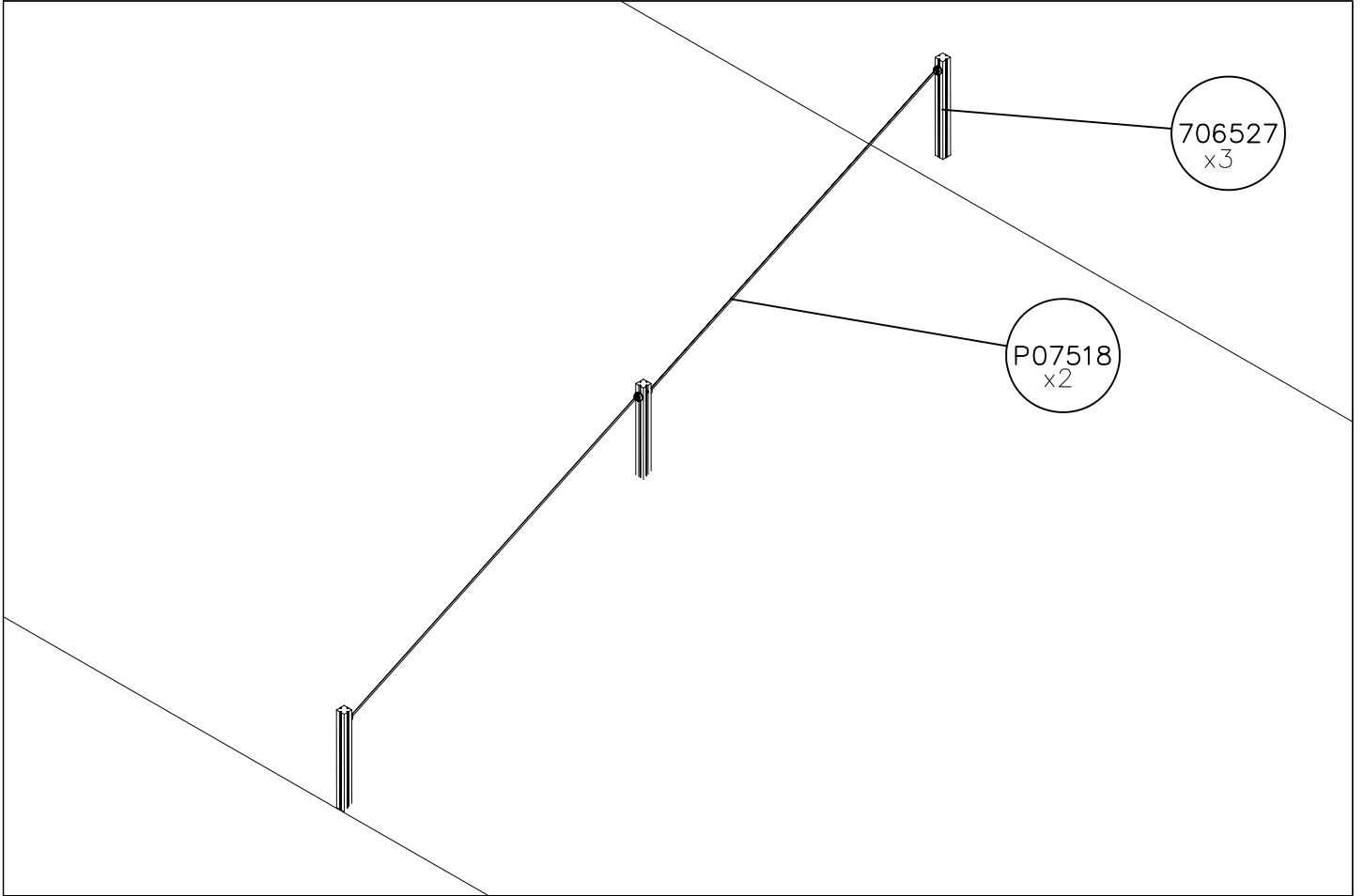

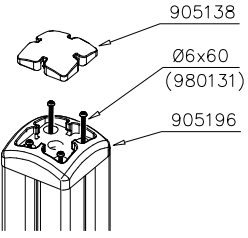
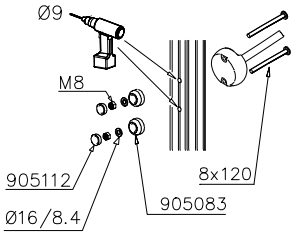
<p>DET 1</p>  <p>905138 Ø6x60 (980131) 905196</p>	<p>DET 2</p>  <p>Ø9 M8 905112 Ø16/8.4 8x120 905083</p>		

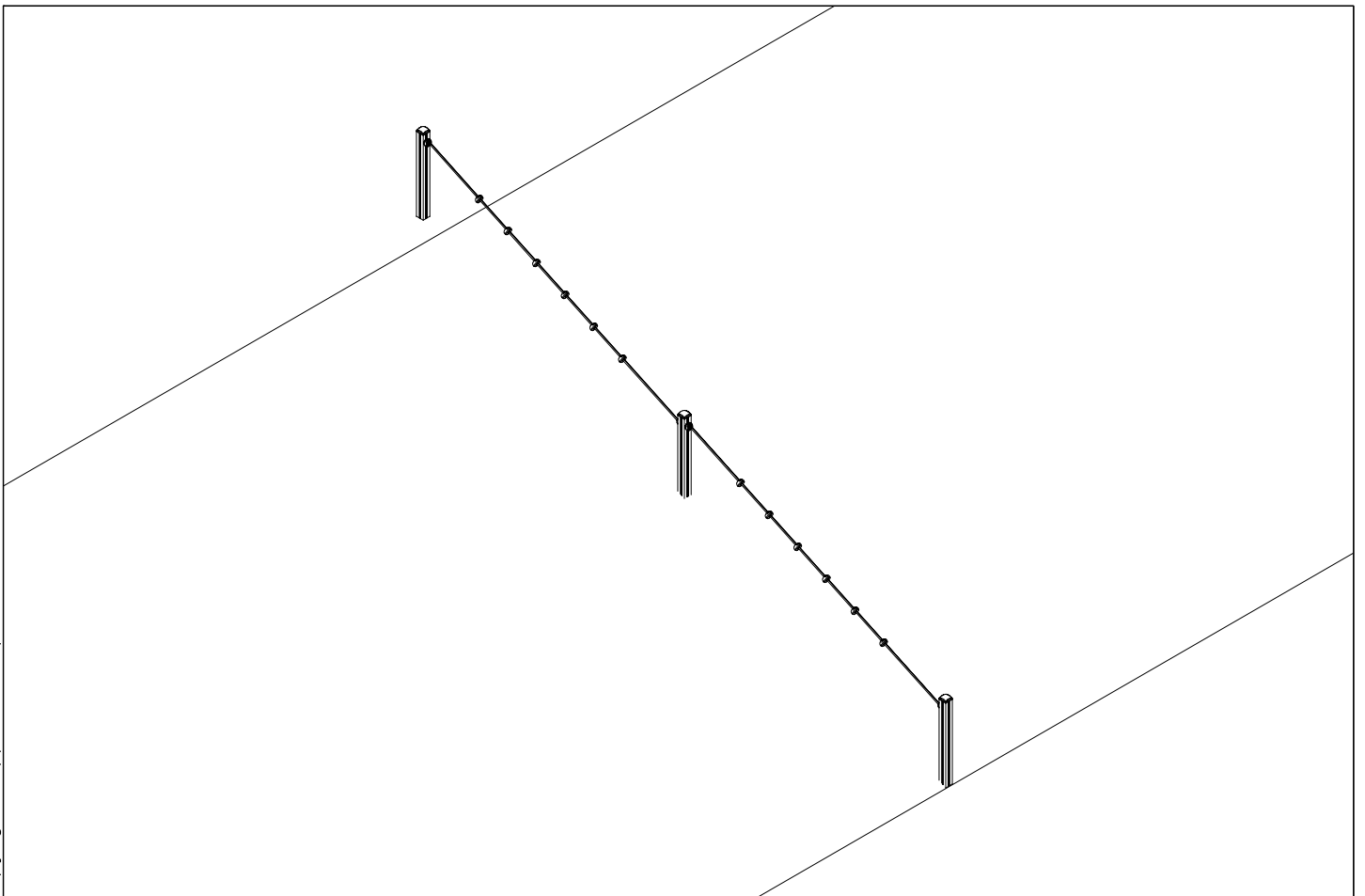
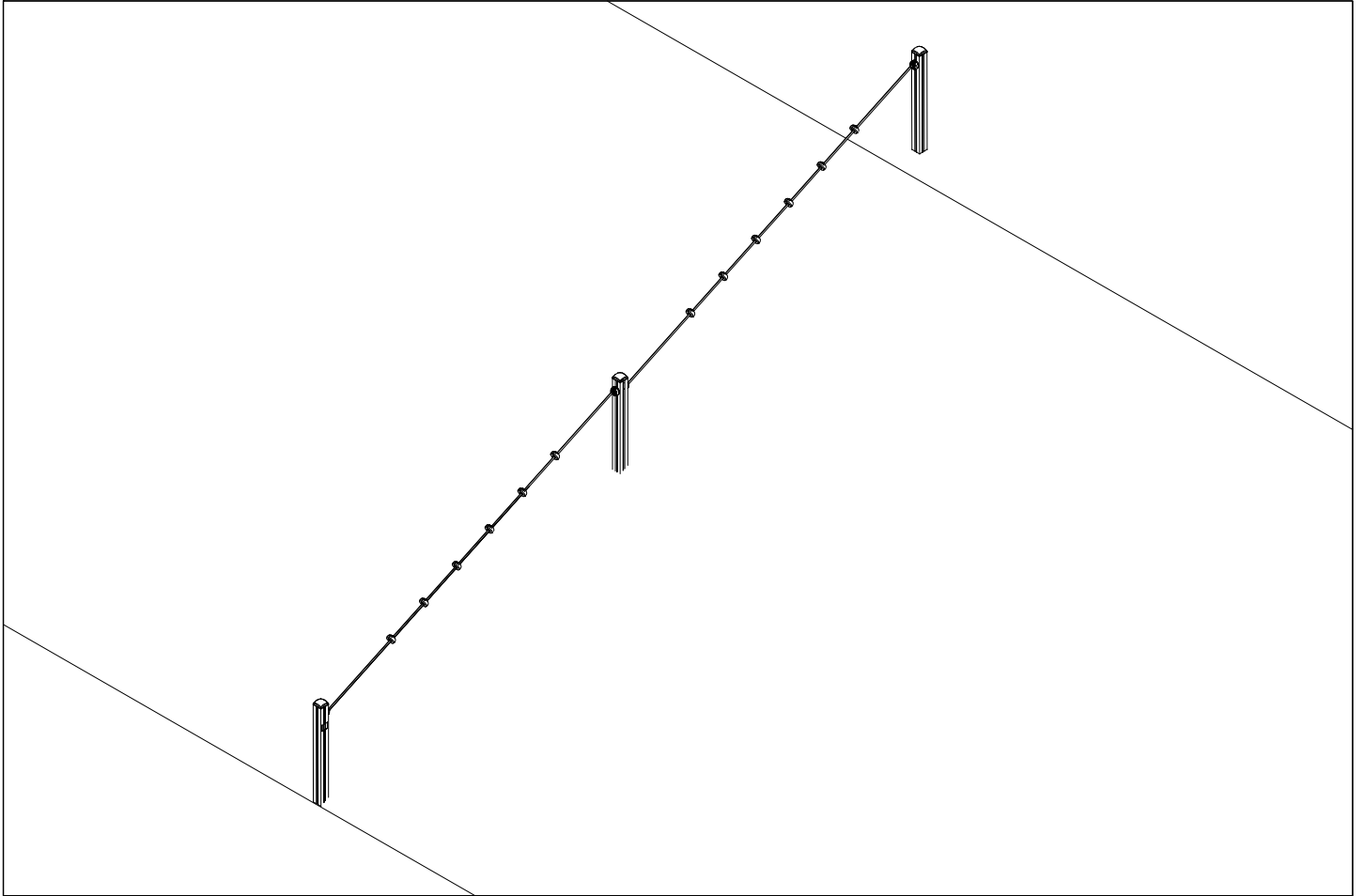

												
<p>$h < 600$</p> <p>Without movement and therefore without Impact Area</p>	<p>Totally hard surfaces.</p> <p>Note. Lappset does <u>not recommend</u> totally hard surfaces at all.</p>	<p>E.g. concrete or asphalt</p> 										
<p>$h < 600$</p> <p>With movement e.g. rocking</p>	<p>Materials with very limited impact attenuating properties.</p>	<p>E.g. wood</p> 										
<p>$h < 1000$</p>	<p>Materials with significant impact attenuating properties.</p>	<p>fine gravel 0–8 mm</p>  <p>grass</p>  <p>unsorted sand</p> 										
<p>$h < 3000$</p>	<p>Loose fill material</p> <p>E.g. sand/gravel 0,25...8 mm D60/D10<3,0 Woodchips 5...30 mm bark 20...80 mm</p>	 <table data-bbox="1024 1691 1332 1780"> <tr> <td>\underline{S}</td> <td>\underline{h}</td> </tr> <tr> <td>30 cm</td> <td>< 2,0 m</td> </tr> <tr> <td>40 cm</td> <td>< 3,0 m</td> </tr> </table>	\underline{S}	\underline{h}	30 cm	< 2,0 m	40 cm	< 3,0 m				
\underline{S}	\underline{h}											
30 cm	< 2,0 m											
40 cm	< 3,0 m											
	<p>Syntethic granulates</p> <table data-bbox="406 1892 758 2060"> <tr> <td>\underline{S}</td> <td>\underline{h}</td> </tr> <tr> <td>40 mm</td> <td>~> 1,2...1,3 m</td> </tr> <tr> <td>50 mm</td> <td>~> 1,5...1,7 m</td> </tr> <tr> <td>60 mm</td> <td>~> 1,8...2,0 m</td> </tr> <tr> <td>70 mm</td> <td>~> 2,1...2,5 m</td> </tr> </table> <p>Note. For accurate values, see manufacturer's instructions.</p>	\underline{S}	\underline{h}	40 mm	~> 1,2...1,3 m	50 mm	~> 1,5...1,7 m	60 mm	~> 1,8...2,0 m	70 mm	~> 2,1...2,5 m	
\underline{S}	\underline{h}											
40 mm	~> 1,2...1,3 m											
50 mm	~> 1,5...1,7 m											
60 mm	~> 1,8...2,0 m											
70 mm	~> 2,1...2,5 m											

REMOVE SAFETY SURFACE/SAND/GRAVEL
TO CHECK FOUNDATION



REMOVE SAFETY SURFACE/SAND/GRAVEL
TO CHECK FOUNDATION



**Tuotekyltti tulee tuotteen mukana yhdellä seuraavista tavoista:****1) Metallinen tuotekyltti ja kiinnitysruuvit**

- Kiinnitä tuotekyltti ruuveilla tolppaan noin 2 metrin korkeuteen kuvan 1 mukaisesti.

2) Tuotekylttitarra

- Puhdista maalattu metalli- tai vaneripinta pölystä ja kosteudesta. Liimaa tarra kuvan 2 mukaisesti.
- Huom. Älä kiinnitä tarraa karheapintaiseen laminaattiin tai maalattuun puuhun.

Vår produktmärkning levereras på ett av följande sätt:**1) Produktskylt i metall**

- Fäst skylten med de medföljande skruvarna

2) Självhäftande produktetikett

- Rengör den pulverlackerade metallytan eller laminatyten så att den blir fri från smuts och fukt. Fäst etiketten enligt fig. 2.
- Obs! Fäst ej etiketten på detaljer med skrovlig yta eller på målat trä.

Product label is delivered by one of following ways:**1) Metal product label and screws**

- Fasten the label with screws.

2) Label sticker

- Clean the painted metal or plywood surface from dirt and moisture. Fasten the sticker as shown in the figure 2.
- Note. Do not attach the sticker to rough surfaced laminate or painted wood.

La plaque d'informations produit est livrée sous l'une de ces 3 formes :**1) Plaque métallique et vis**

- Fixez la plaque à l'aide des vis.

2) Etiquette autocollante

- Avant de coller l'étiquette, nettoyez le composant métallique peint ou la plaque de contreplaqué, de toute saleté. La surface doit être sèche (voir image 2).
- Attention, ne pas coller l'étiquette sur une surface lamellé-collée irrégulière ou sur du bois peint.

Die Auslieferung des Produktaufklebers erfolgt auf eine dieser Arten:**1) Produkt-Schild aus Metall incl. Schrauben**

- Die Befestigung des Schildes erfolgt mittels der Schrauben.

2) Aufkleber

- Entfernen Sie zunächst Schmutz und Feuchtigkeit vom lackierten Metall bzw. von der Holzoberfläche und bringen Sie den Aufkleber wie im Bild oben rechts beschrieben auf den gesäuberten Untergrund auf.
- Beachten Sie: Bringen Sie den Aufkleber nicht auf raues laminiertes oder lackiertes Holz an.