

# **LAPPSET®**

## **FINNO**







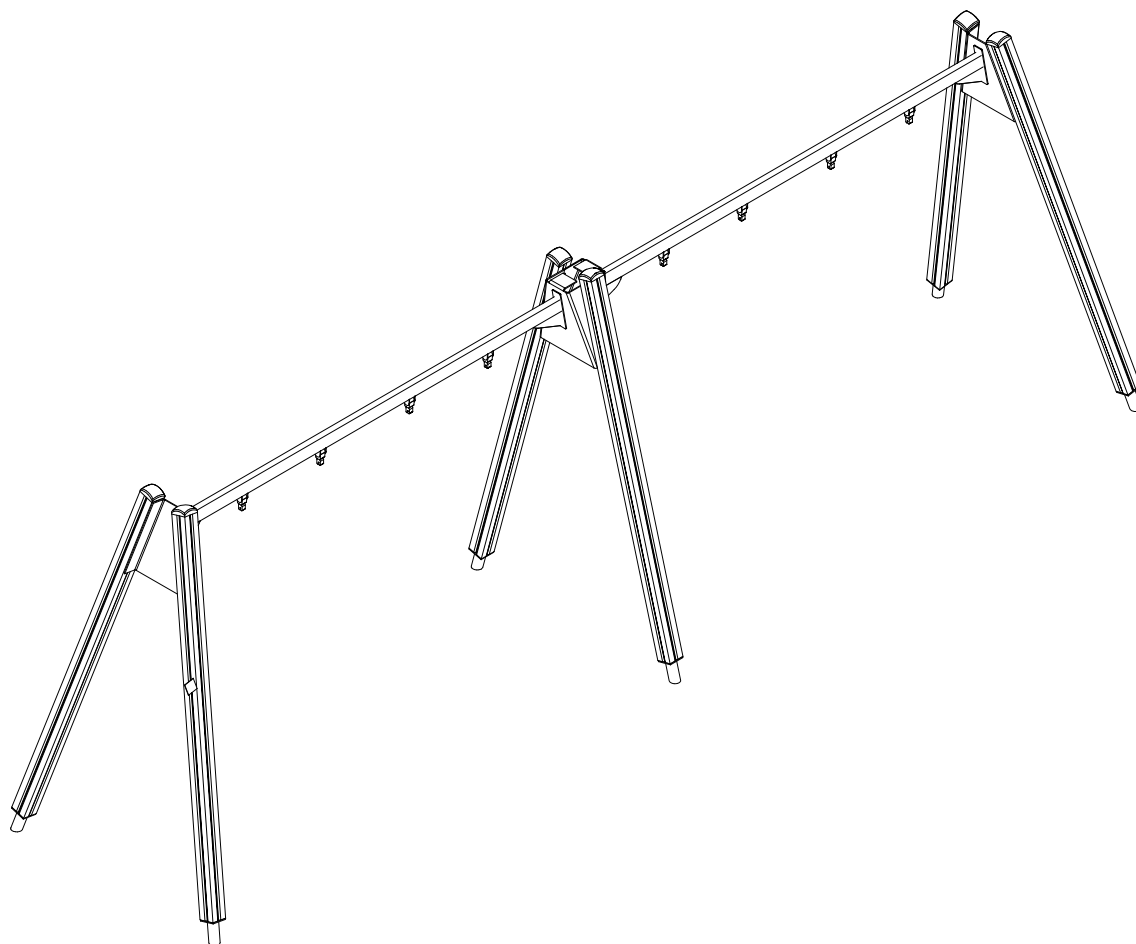

ASENNUSOHJE  
MONTERINGSANSVISNING  
INSTALLATION INSTRUCTION  
AUFBAUANLEITUNG  
NOTICE D'INSTALLATION

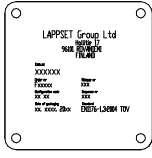
DATE: 28.11.2022

### **Q12864-2**

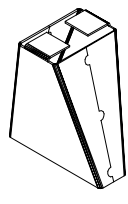
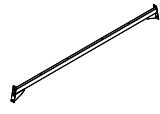
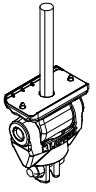
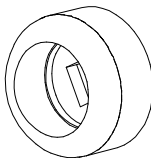
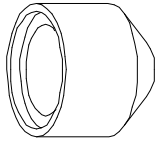
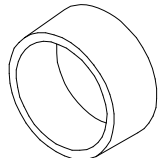
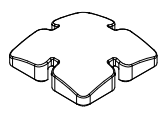
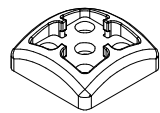
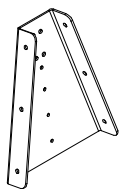

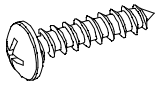
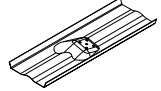
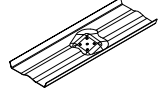
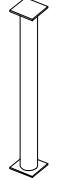
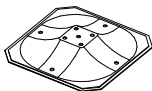
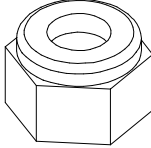
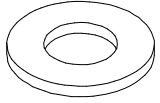
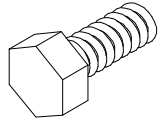
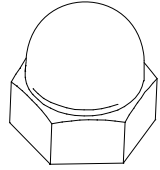
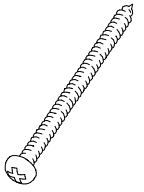
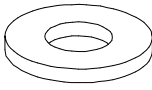
DATE: 28.11.2022

702286  65x65	PCS 1	706562  L2250	PCS 6	900965  M10	PCS 8	903149  M12x30	PCS 8	904317 	PCS 1	904333  L2940	PCS 2
904904 	PCS 8	905090  Ø45	PCS 18	905104  M10	PCS 24	905115  Ø30	PCS 18	905138 	PCS 6	905196 	PCS 6
905991 	PCS 2	909347  M12x35	PCS 18	909506  Ø3.5x13	PCS 4	909507  L 1000	PCS 2	909508  L 1000	PCS 2	909511  L650	PCS 6
909519 	PCS 2	909637  M10	PCS 24	909638  Ø20/10.5	PCS 64	909639  M10x25	PCS 32	909644  M12	PCS 8	980131  Ø6x60	PCS 24
980154  Ø24x13	PCS 34	999561  10g	PCS 1		PCS		PCS		PCS		PCS
	PCS		PCS		PCS		PCS		PCS		PCS
	PCS		PCS		PCS		PCS		PCS		PCS

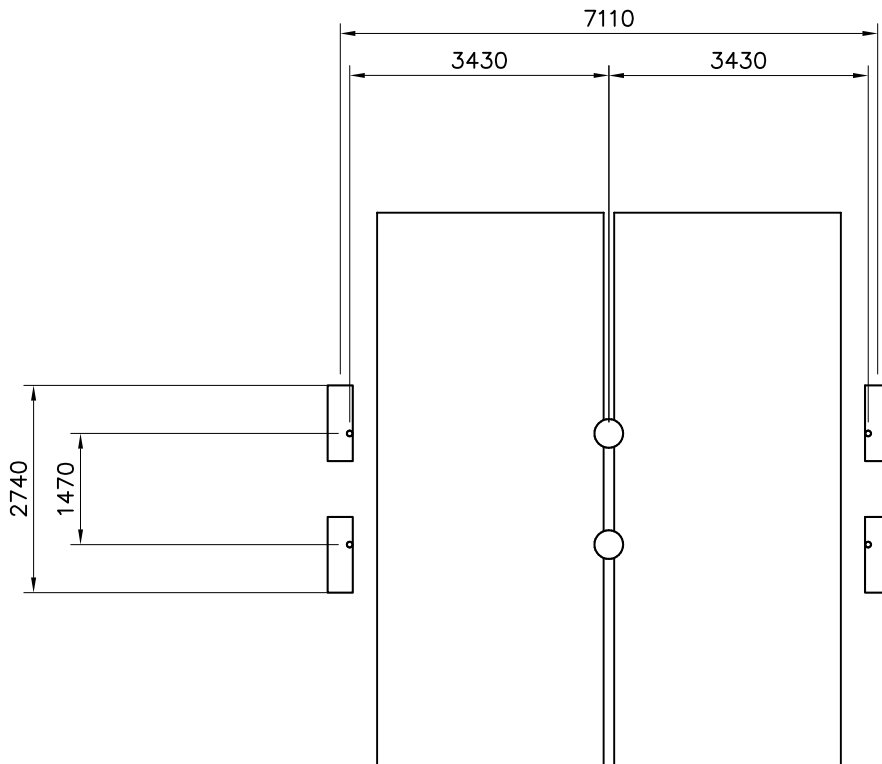
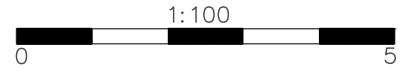

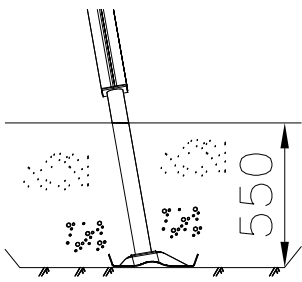
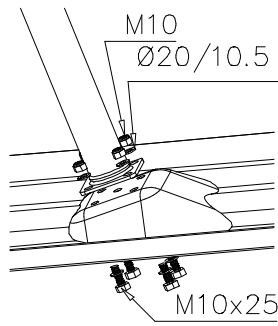
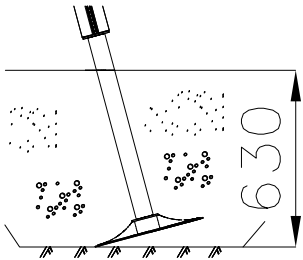
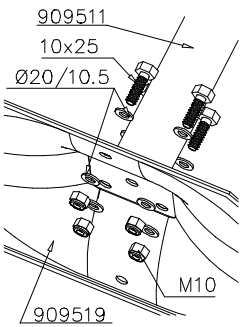
 <p>550</p>	 <p>M10 Ø20/10.5 M10x25</p>	 <p>630</p>
 <p>909511 10x25 Ø20/10.5 M10 909519</p>		

- EN/AS Impact Area 43.8 m<sup>2</sup>
- - - Falling Space 43.8 m<sup>2</sup>  
Max Falling Height 1200 mm

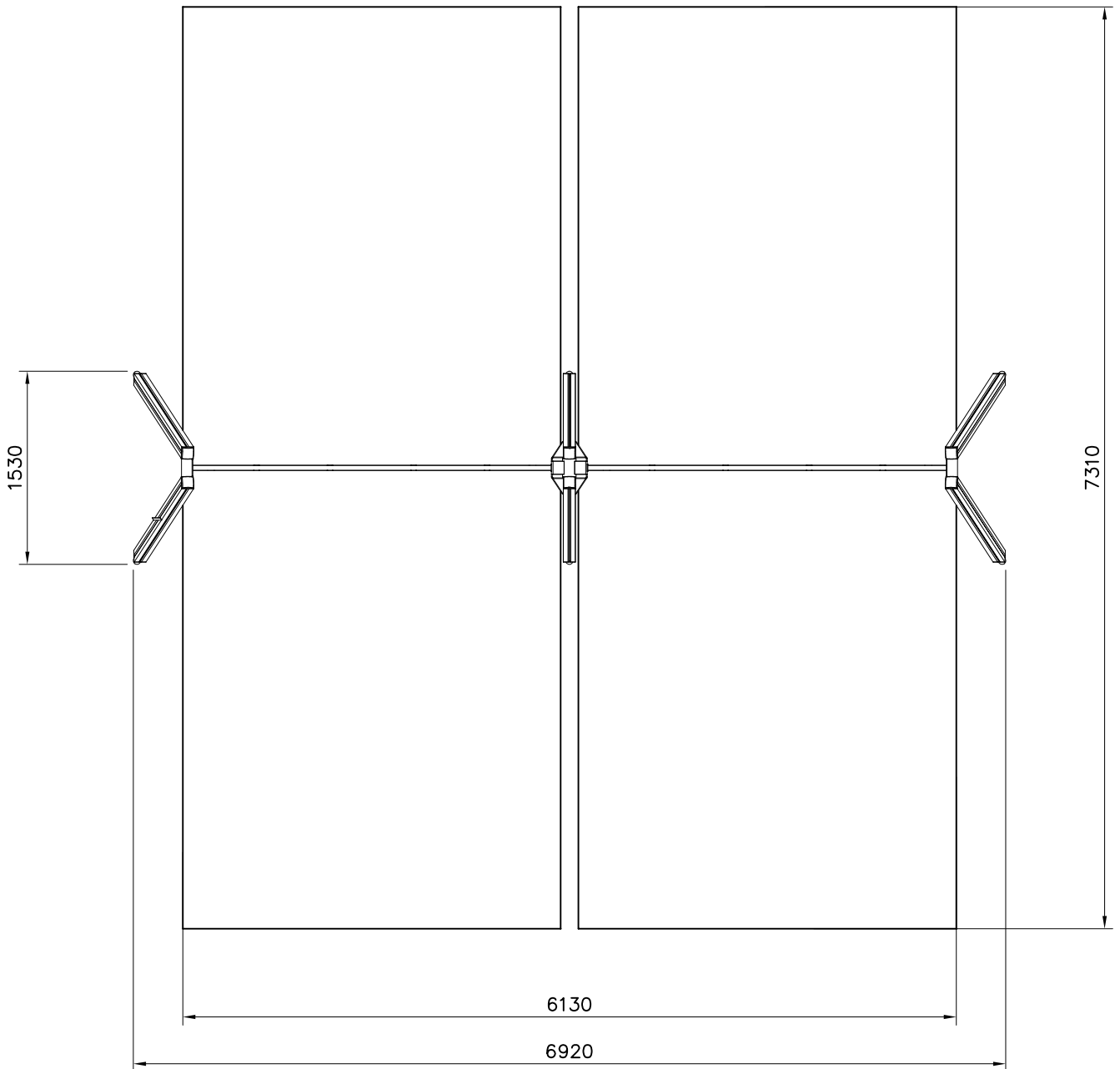

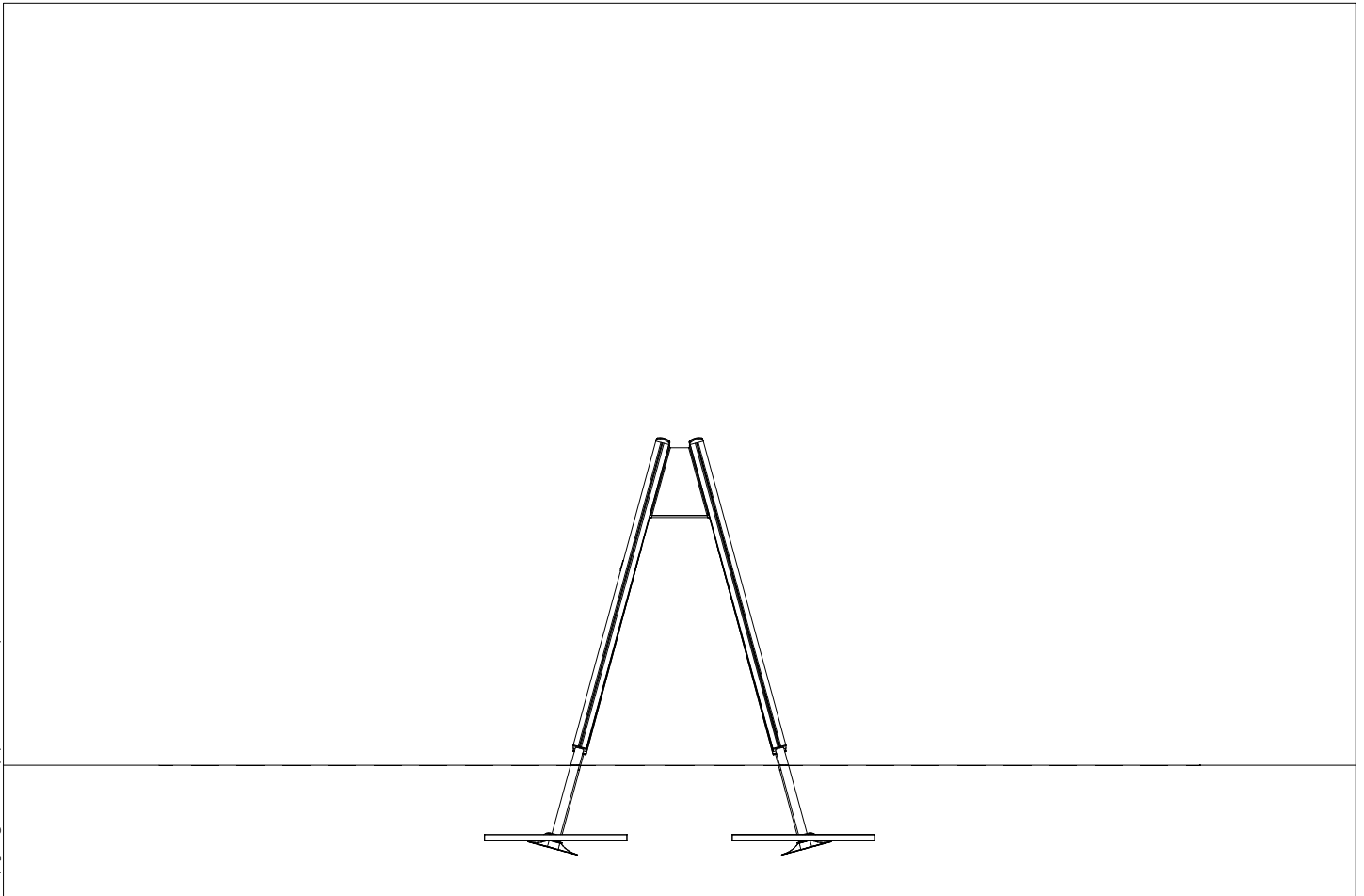
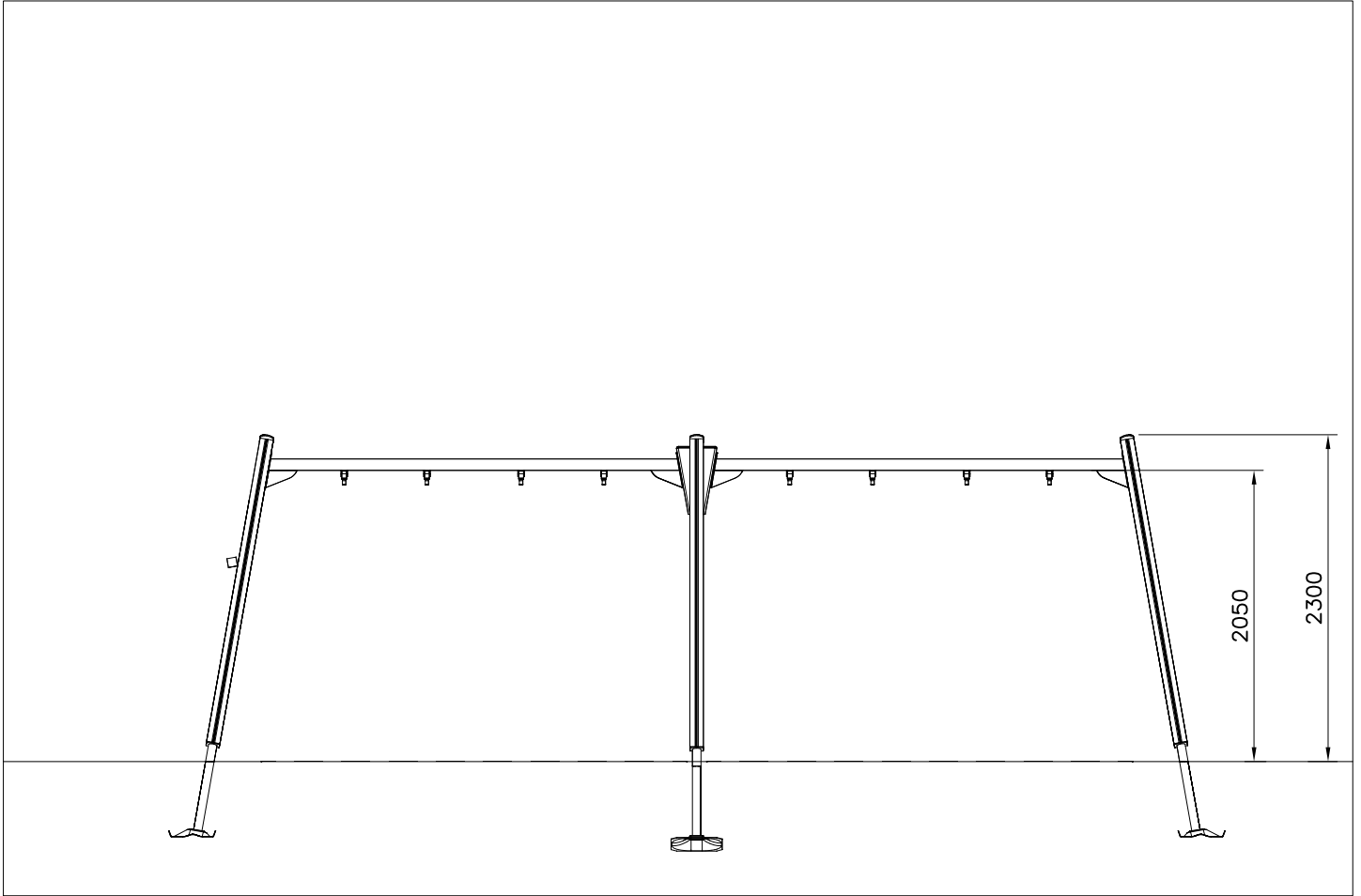

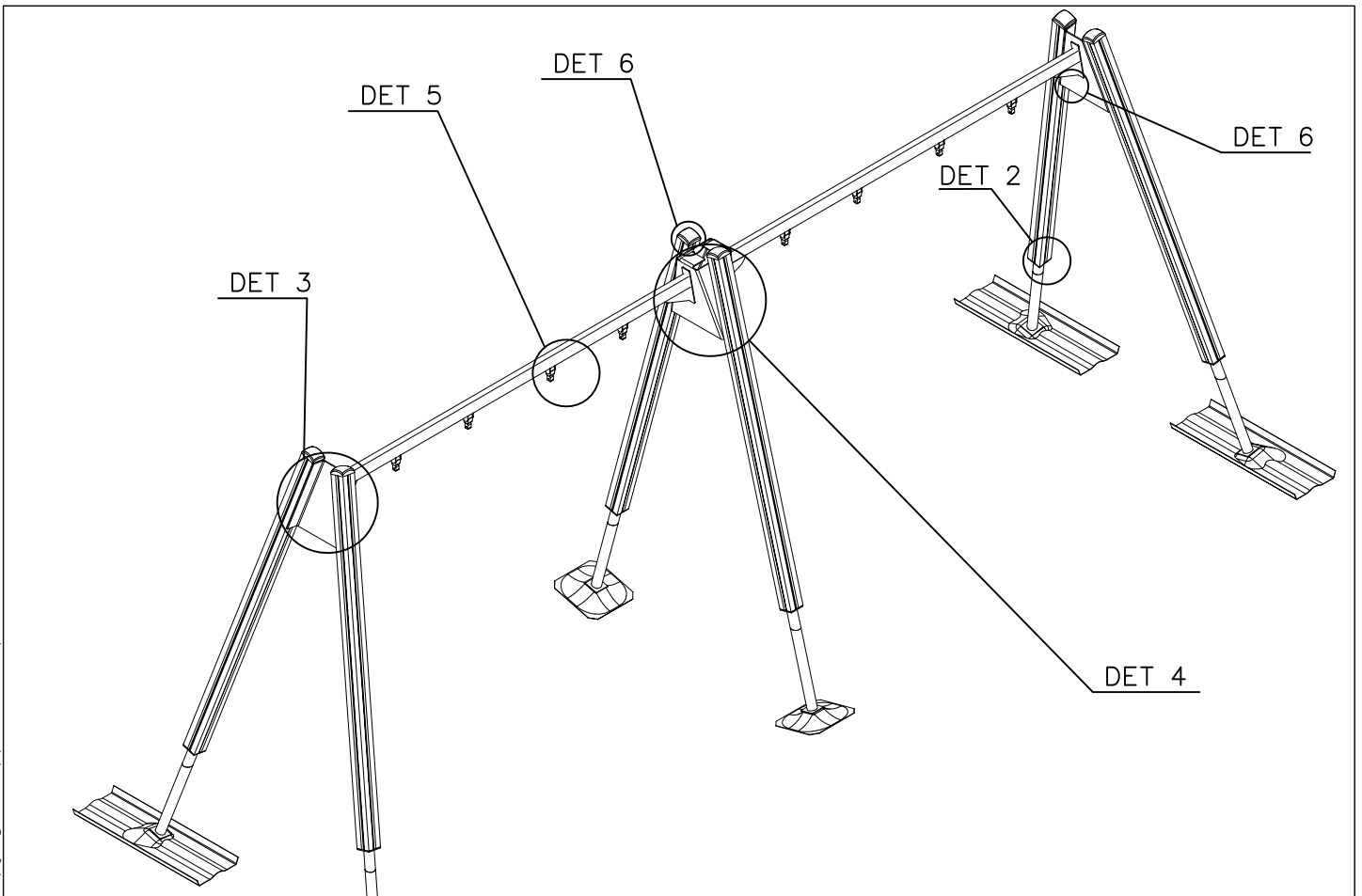
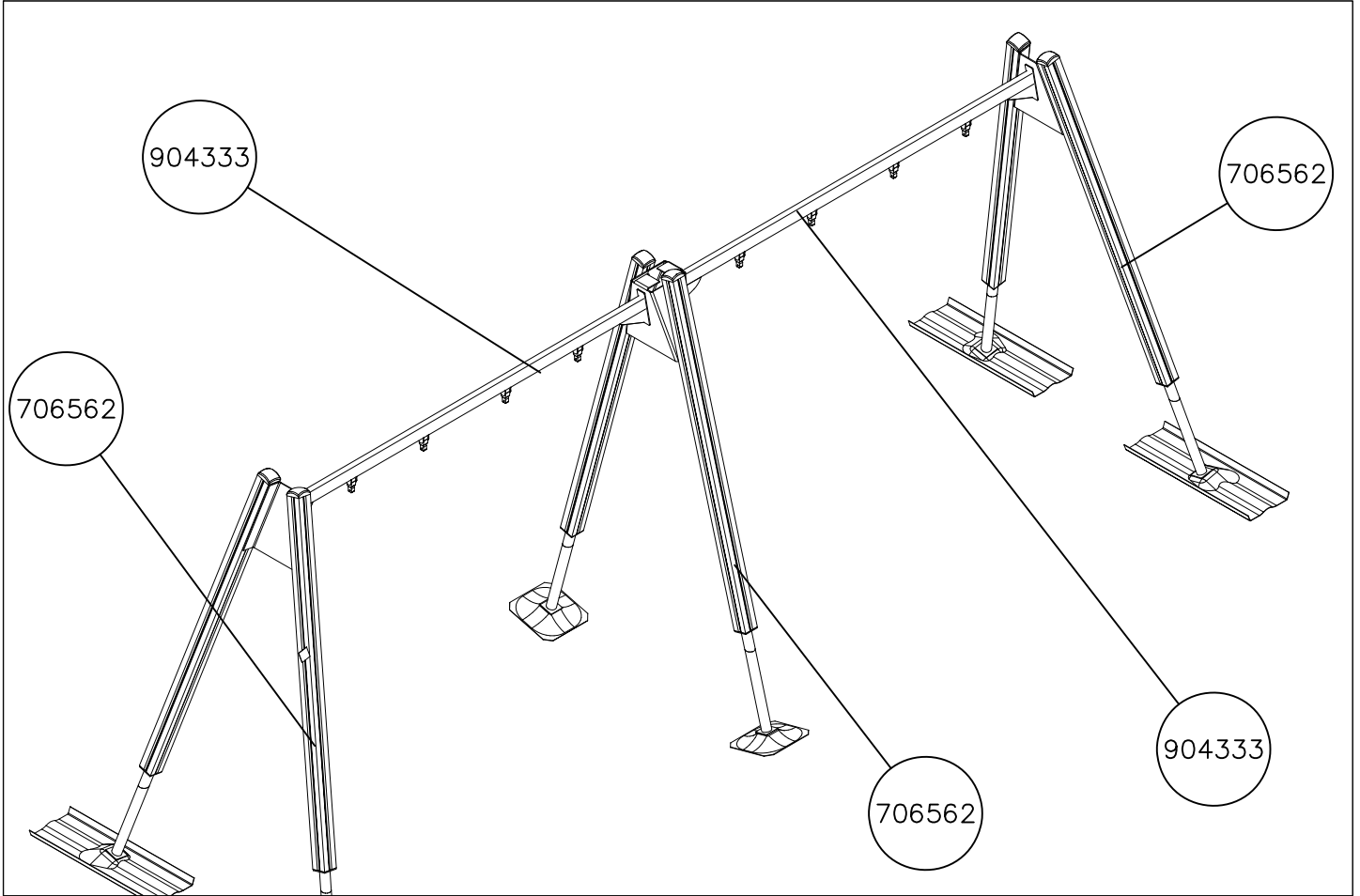

<p>DET 1</p> <p>6x60 980131</p>	<p>DET 2</p> <p>M10 905104 909521</p>	<p>DET 3</p> <p>M12 → 80 Nm Ø24/13 M12x30 M12 M10x25 Ø20/10.5 M10 → 45 Nm</p>	<p>DET 4</p> <p>904317</p>
<p>DET 5</p> <p>90Nm M12 980154 Ø24/13 904904</p>	<p>DET 6</p> <p>999561 GLUE Ø24/13 905115 12x35 905090</p>		



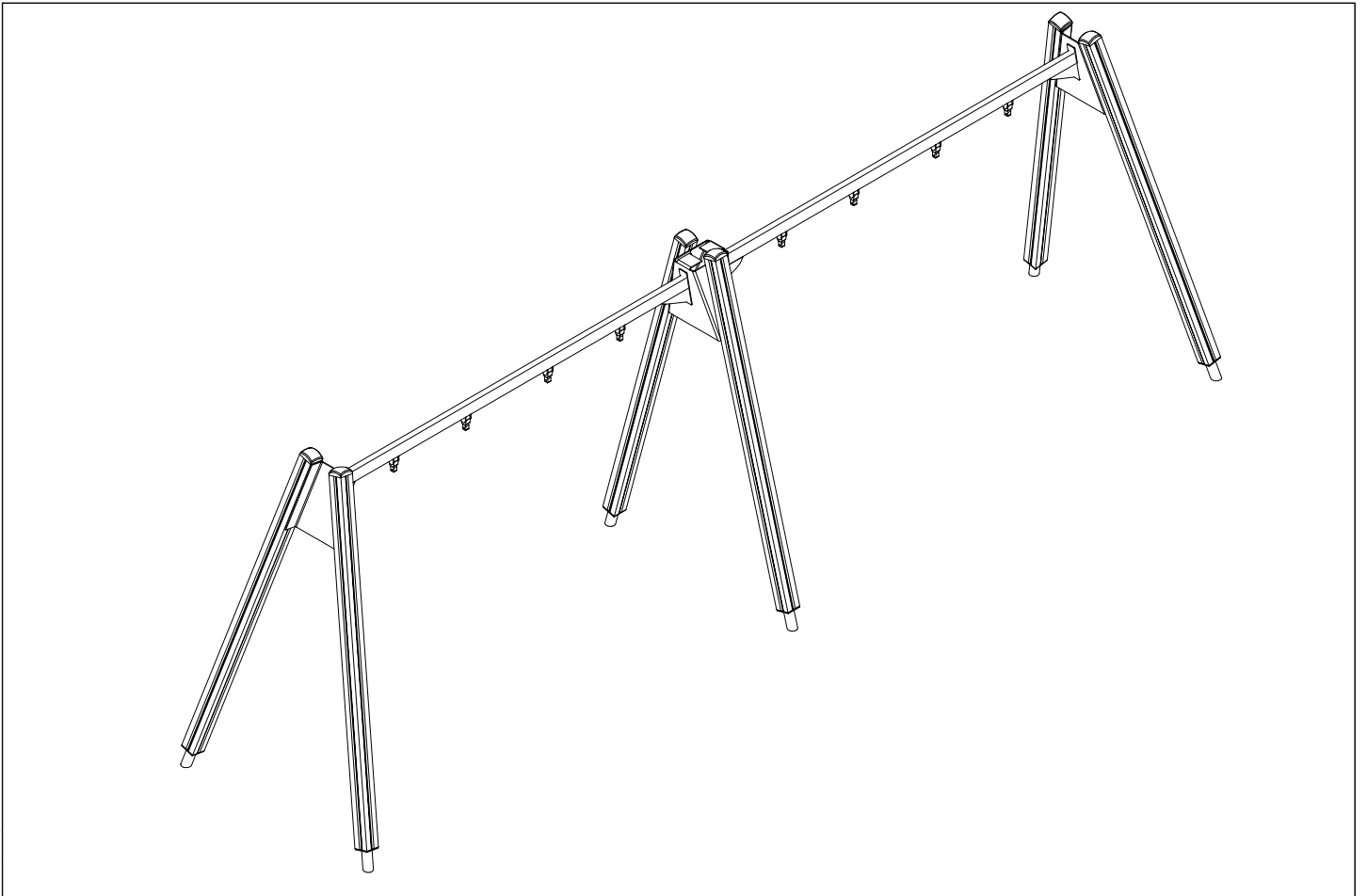
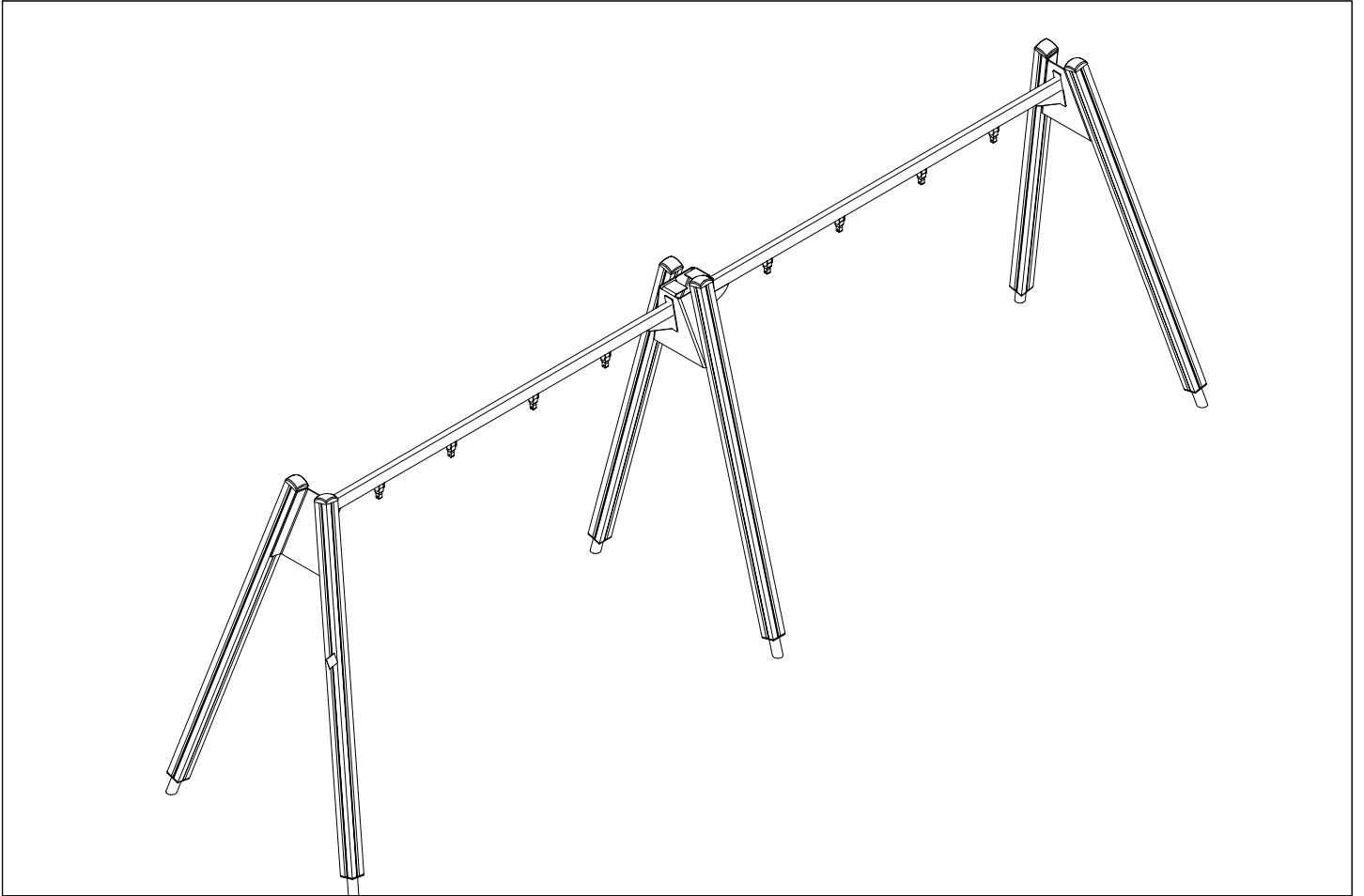

		
<p><b><math>h &lt; 600</math></b></p> <p>Without movement and therefore without Impact Area</p>	<p>Totally hard surfaces.</p> <p>Note. Lappset does <u>not recommend</u> totally hard surfaces at all.</p>	<p>E.g. concrete or asphalt</p> 
<p><b><math>h &lt; 600</math></b></p> <p>With movement e.g. rocking</p>	<p>Materials with very limited impact attenuating properties.</p>	<p>E.g. wood</p> 
<p><b><math>h &lt; 1000</math></b></p>	<p>Materials with significant impact attenuating properties.</p>	<p>fine gravel 0–8 mm</p>  <p>grass</p>  <p>unsorted sand</p> 
<p><b><math>h &lt; 3000</math></b></p>	<p>Loose fill material</p> <p>E.g. sand/gravel 0,25...8 mm D60/D10&lt;3,0 Woodchips 5...30 mm bark 20...80 mm</p>	 <p><math>\underline{S}</math>                      <math>\underline{h}</math></p> <p>30 cm                      &lt; 2,0 m</p> <p>40 cm                      &lt; 3,0 m</p>
	<p>Syntethic granulates</p> <p><math>\underline{S}</math>                      <math>\underline{h}</math></p> <p>40 mm ~&gt; 1,2...1,3 m</p> <p>50 mm ~&gt; 1,5...1,7 m</p> <p>60 mm ~&gt; 1,8...2,0 m</p> <p>70 mm ~&gt; 2,1...2,5 m</p> <p>Note. For accurate values, see manufacturer's instructions.</p>	

REMOVE SAFETY SURFACE/SAND/GRAVEL  
TO CHECK FOUNDATION



REMOVE SAFETY SURFACE/SAND/GRAVEL  
TO CHECK FOUNDATION



**LAPPSET®**  
**BETON FOUNDATION**

**FOOT**

DATE: 27.10.2015

**1(1)**

② 905104	PCS		PCS
	4		
 M10	PCS		PCS

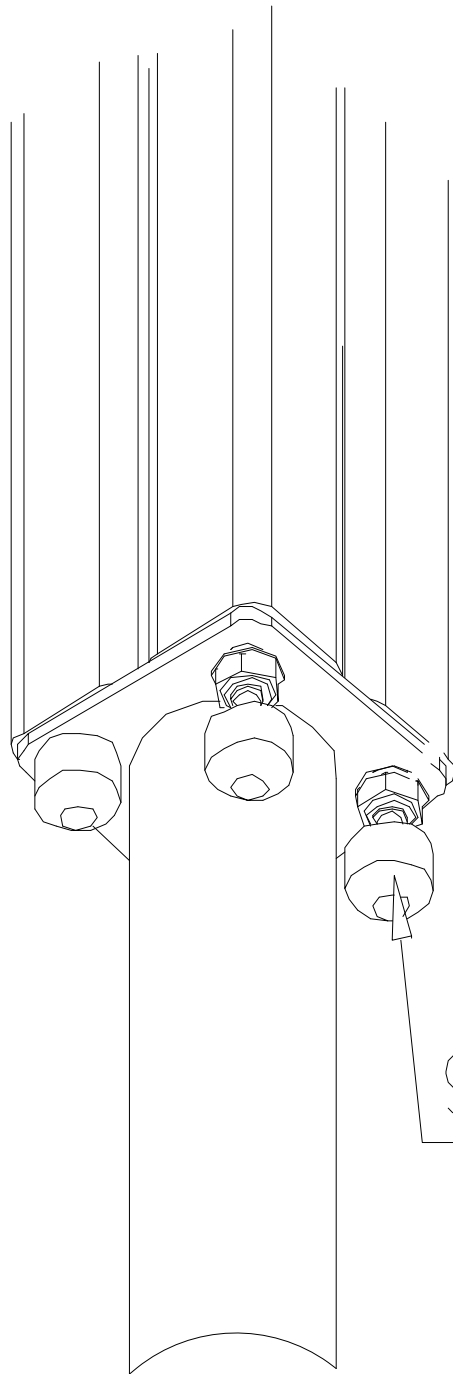

905104



## Tuotekyltti tulee tuotteen mukana yhdellä seuraavista tavoista:

### 1) Metallinen tuotekyltti ja kiinnitysruuvit

- Kiinnitä tuotekyltti ruuveilla tolppaan noin 2 metrin korkeuteen kuvan 1 mukaisesti.

### 2) Tuotekylttitarra

- Puhdista maalattu metalli- tai vaneripinta pölystä ja kosteudesta. Liimaa tarra kuvan 2 mukaisesti.
- Huom. Älä kiinnitä tarraa karheapintaiseen laminaattiin tai maalattuun puuhun.

## Vår produktmärkning levereras på ett av följande sätt:

### 1) Produktskylt i metall

- Fäst skylten med de medföljande skruvarna

### 2) Självhäftande produktetikett

- Rengör den pulverlackerade metallytan eller laminatyten så att den blir fri från smuts och fukt. Fäst etiketten enligt fig. 2.
- Obs! Fäst ej etiketten på detaljer med skrovlig yta eller på målat trä.

## Product label is delivered by one of following ways:

### 1) Metal product label and screws

- Fasten the label with screws.

### 2) Label sticker

- Clean the painted metal or plywood surface from dirt and moisture. Fasten the sticker as shown in the figure 2.
- Note. Do not attach the sticker to rough surfaced laminate or painted wood.

## La plaque d'informations produit est livrée sous l'une de ces 3 formes :

### 1) Plaque métallique et vis

- Fixez la plaque à l'aide des vis.

### 2) Etiquette autocollante

- Avant de coller l'étiquette, nettoyez le composant métallique peint ou la plaque de contreplaqué, de toute saleté. La surface doit être sèche (voir image 2).
- Attention, ne pas coller l'étiquette sur une surface lamellé-collée irrégulière ou sur du bois peint.

## Die Auslieferung des Produktaufklebers erfolgt auf eine dieser Arten:

### 1) Produkt-Schild aus Metall incl. Schrauben

- Die Befestigung des Schildes erfolgt mittels der Schrauben.

### 2) Aufkleber

- Entfernen Sie zunächst Schmutz und Feuchtigkeit vom lackierten Metall bzw. von der Holzoberfläche und bringen Sie den Aufkleber wie im Bild oben rechts beschrieben auf den gesäuberten Untergrund auf.
- Beachten Sie: Bringen Sie den Aufkleber nicht auf raues laminiertes oder lackiertes Holz an.