

LAPPSET®

FLORA











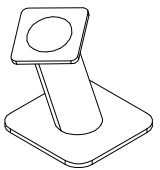
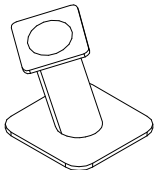
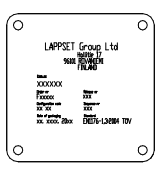

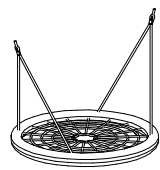
ASENNUSOHJE
MONTERINGSANSVISNING
INSTALLATION INSTRUCTION
AUFBAUANLEITUNG
NOTICE D'INSTALLATION

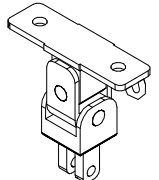
DATE: 24.11.2022

Q10074-5

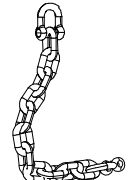
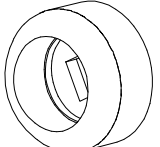
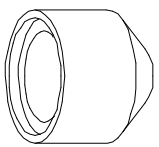
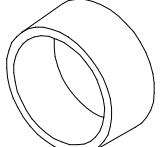
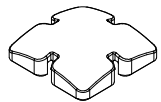
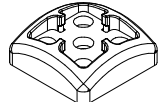
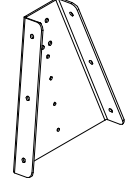
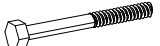

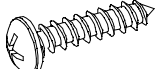
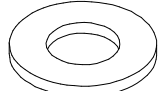
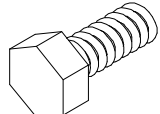
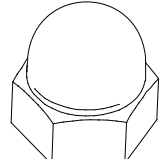
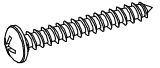
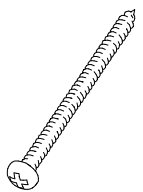
DATE: 24.11.2022

 701902 L 150	PCS 2	 701903 L 150	PCS 2	 702286 65x65	PCS 1	 702533 118x78	PCS 1	 706562 FLORA L2250	PCS 4	 706947	PCS 1
 900965 M10	PCS 4	 901958	PCS 2	 901959 L2940	PCS 1	 902234 M12	PCS 4	 903149 M12x30	PCS 4	 903577	PCS 2
 905090 Ø45	PCS 12	 905104 M10	PCS 16	 905115 Ø30	PCS 12	 905138	PCS 4	 905196	PCS 4	 905991	PCS 2
 906499 M12x110	PCS 4	 909347 M12x35	PCS 12	 909506 Ø3.5x13	PCS 4	 909638 Ø20/10.5	PCS 8	 909639 M10x25	PCS 4	 909644 M12	PCS 4
 980114 Ø4x20	PCS 4	 980131 Ø6x60	PCS 16	 980154 Ø24x13	PCS 28	 999561 10g	PCS 1		PCS		PCS
	PCS		PCS		PCS		PCS		PCS		PCS
	PCS		PCS		PCS		PCS		PCS		PCS

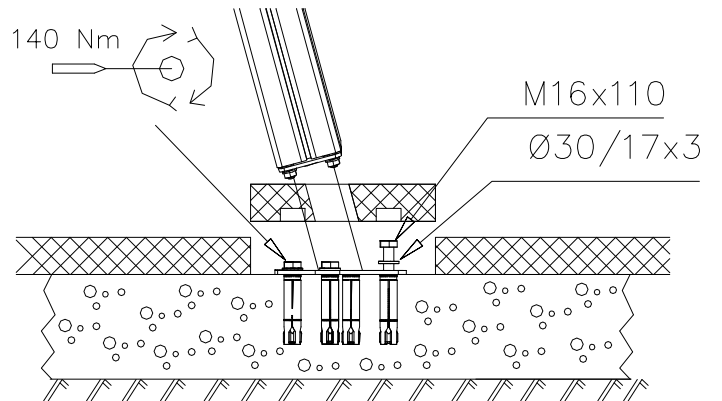
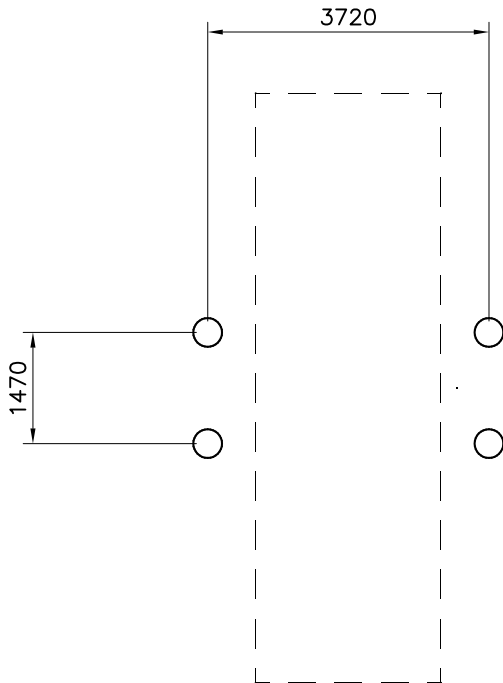

- EN/AS Impact Area 19.1 m²
- - - Falling Space 19.1 m²
Max Falling Height 1200 mm

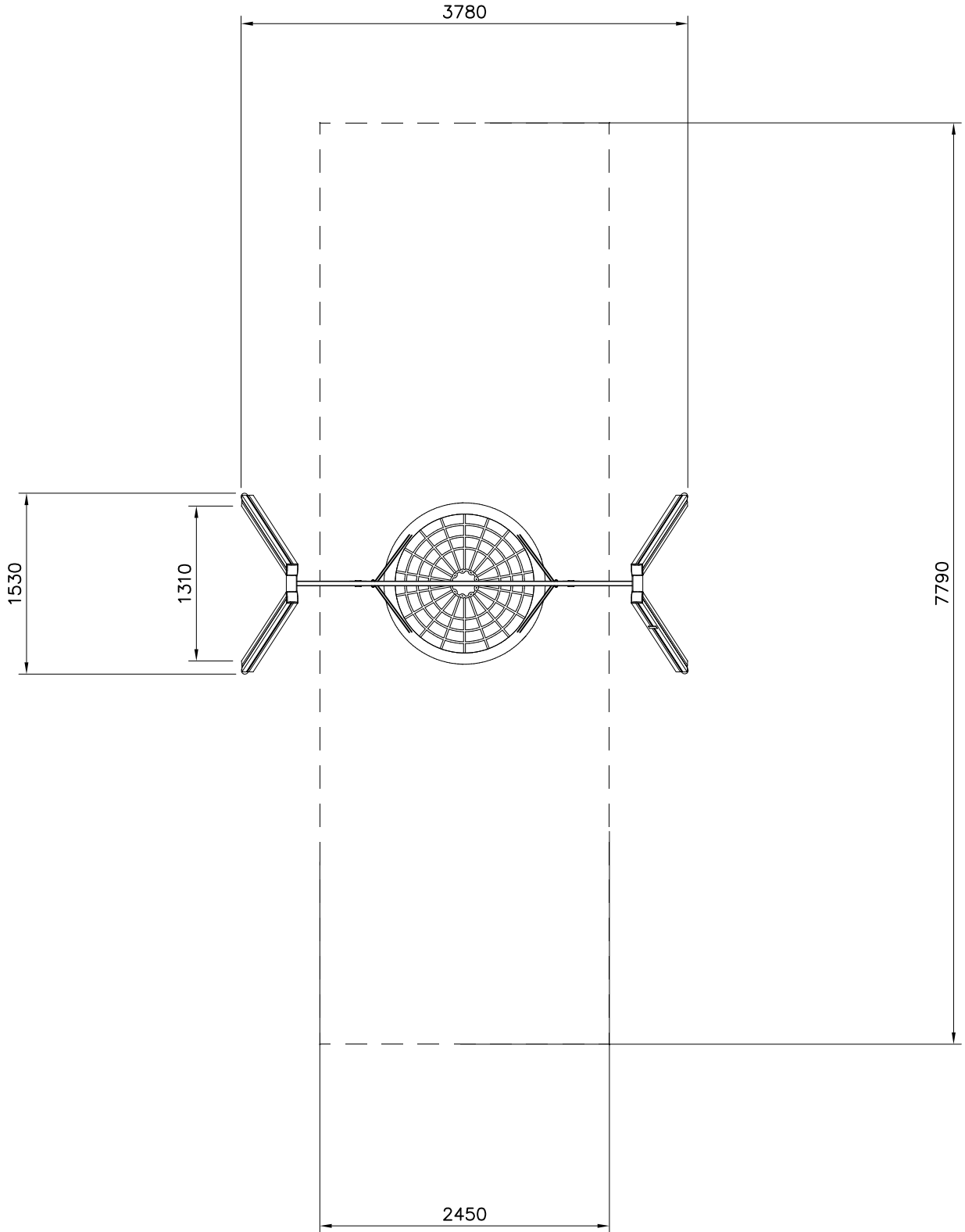

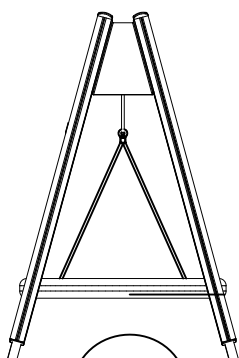
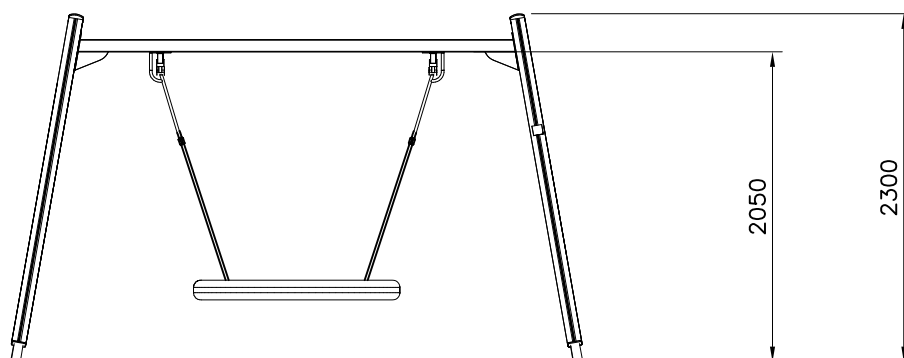

DET 5

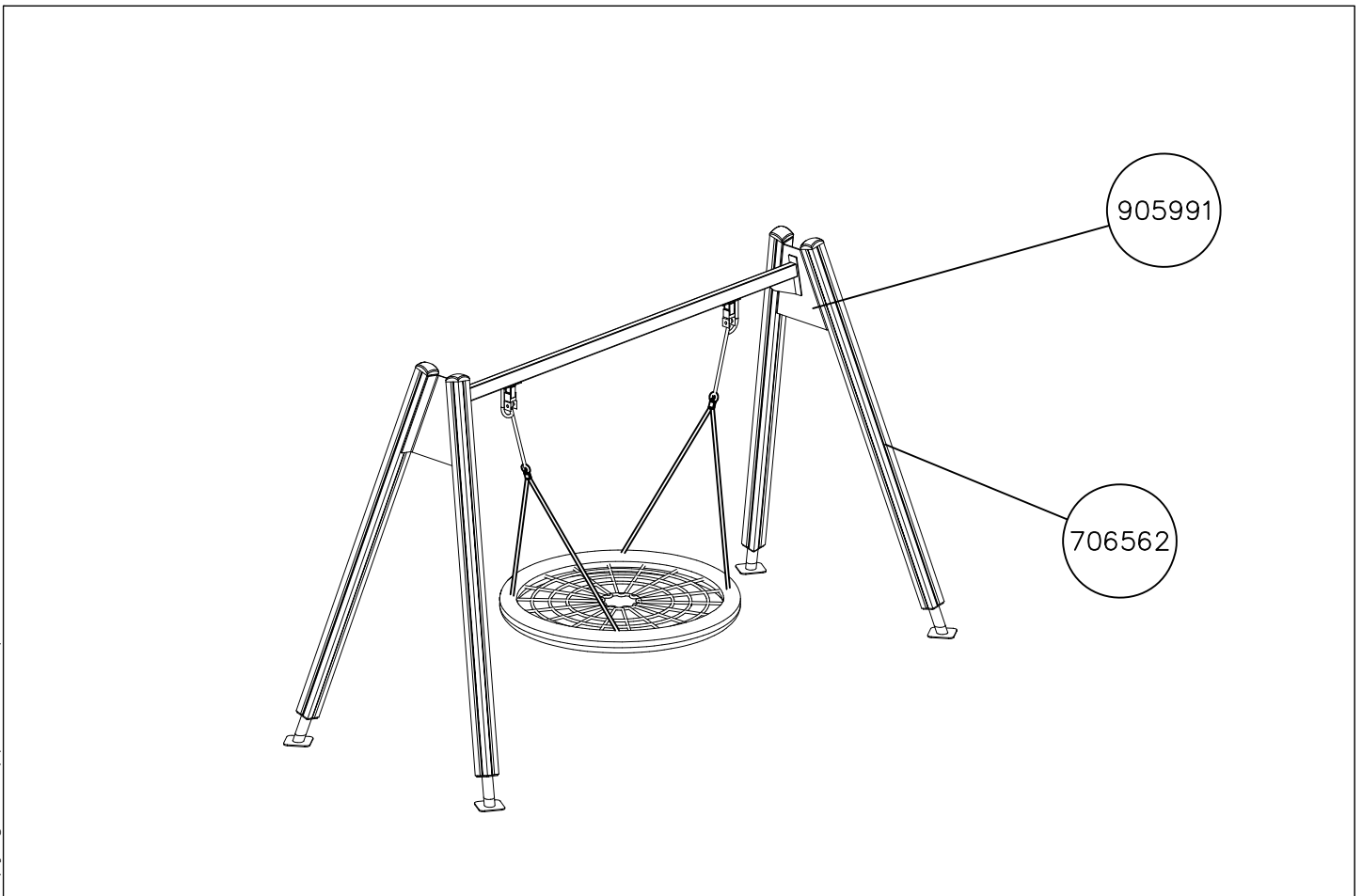
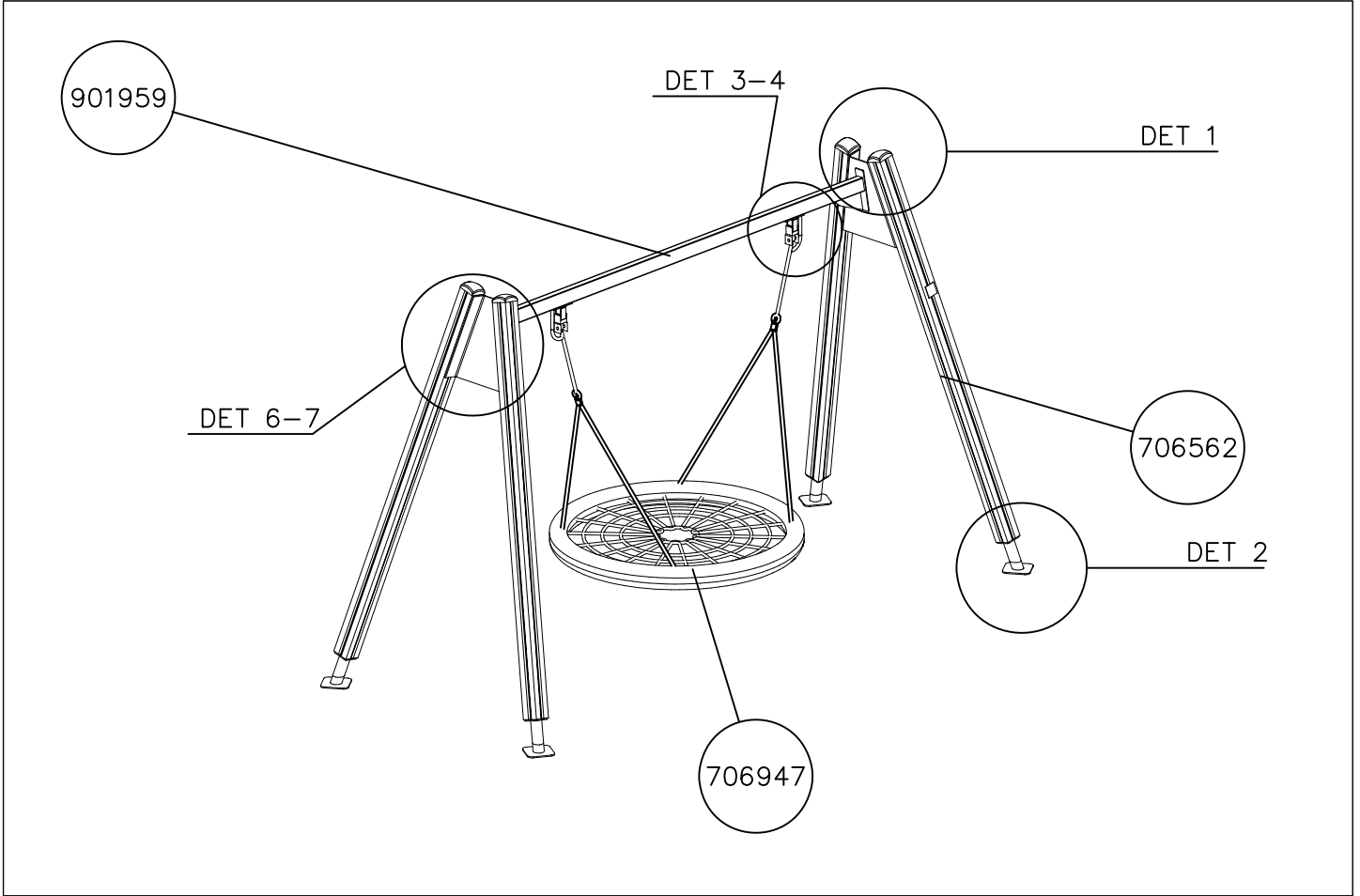

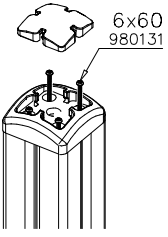
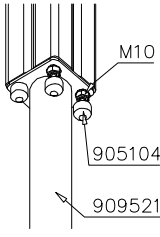
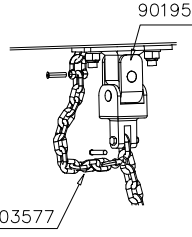
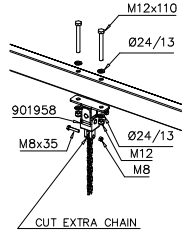
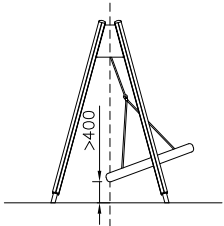
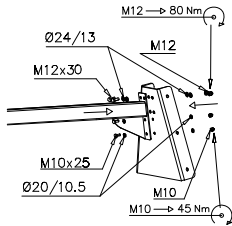
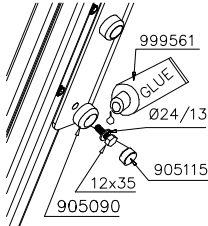
<p>DET 1</p>  <p>6x60 980131</p>	<p>DET 2</p>  <p>M10 905104 909521</p>	<p>DET 3</p>  <p>901958 903577</p>	<p>DET 4</p>  <p>M12x110 Ø24/13 901958 Ø24/13 M8x35 M12 M8 CUT EXTRA CHAIN</p>
<p>DET 5</p>  <p>>400</p>	<p>DET 6</p>  <p>M12 → 80 Nm Ø24/13 M12 M12x30 M10x25 Ø20/10.5 M10 M10 → 45 Nm</p>	<p>DET 7</p>  <p>999561 GLUE Ø24/13 12x35 905115 905090</p>	

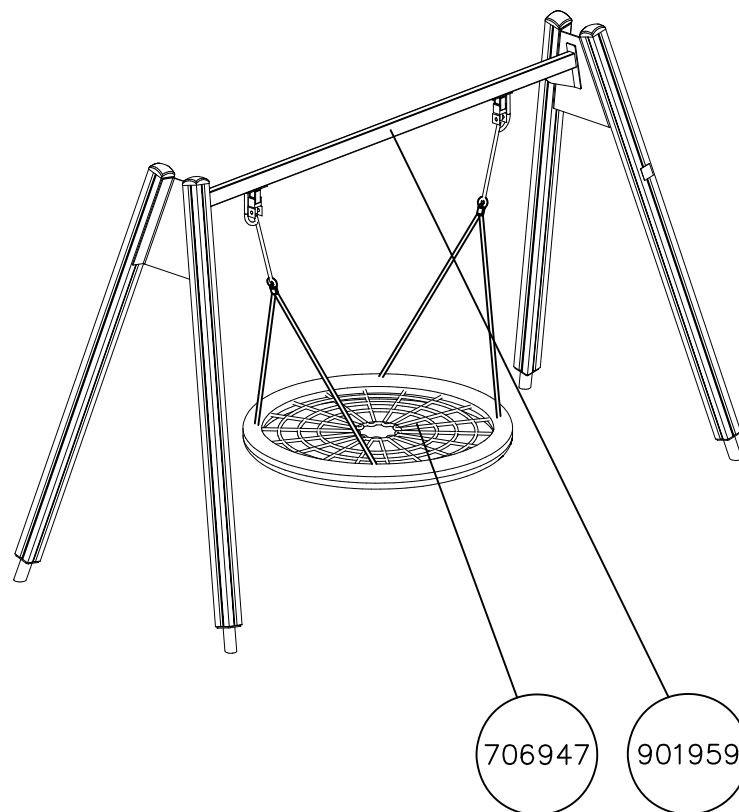

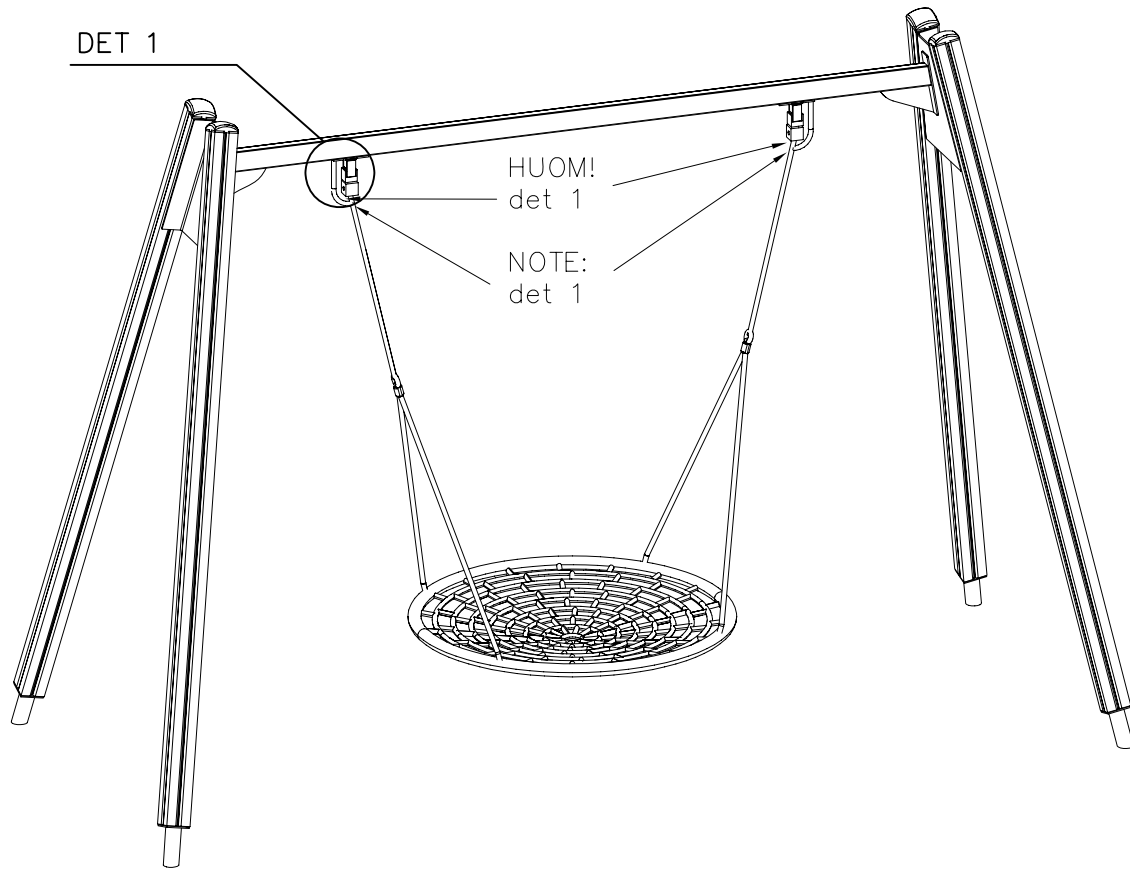

DET 1

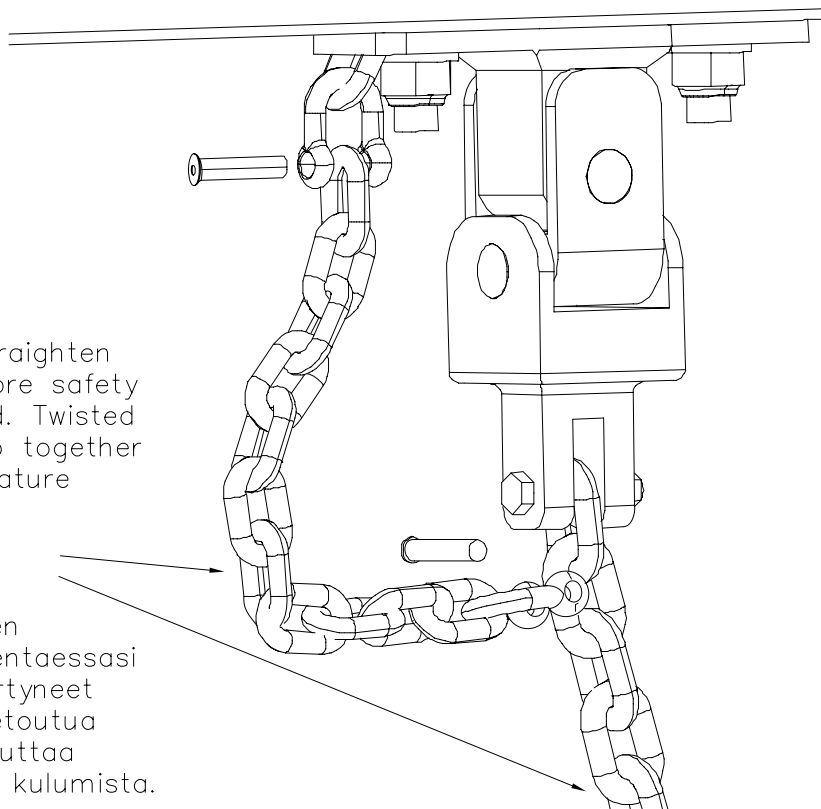

LAPPSET®
BETON FOUNDATION

FOOT

DATE: 27.10.2015

1(1)

② 905104	PCS		PCS
	4		
 M10	PCS		PCS



905104

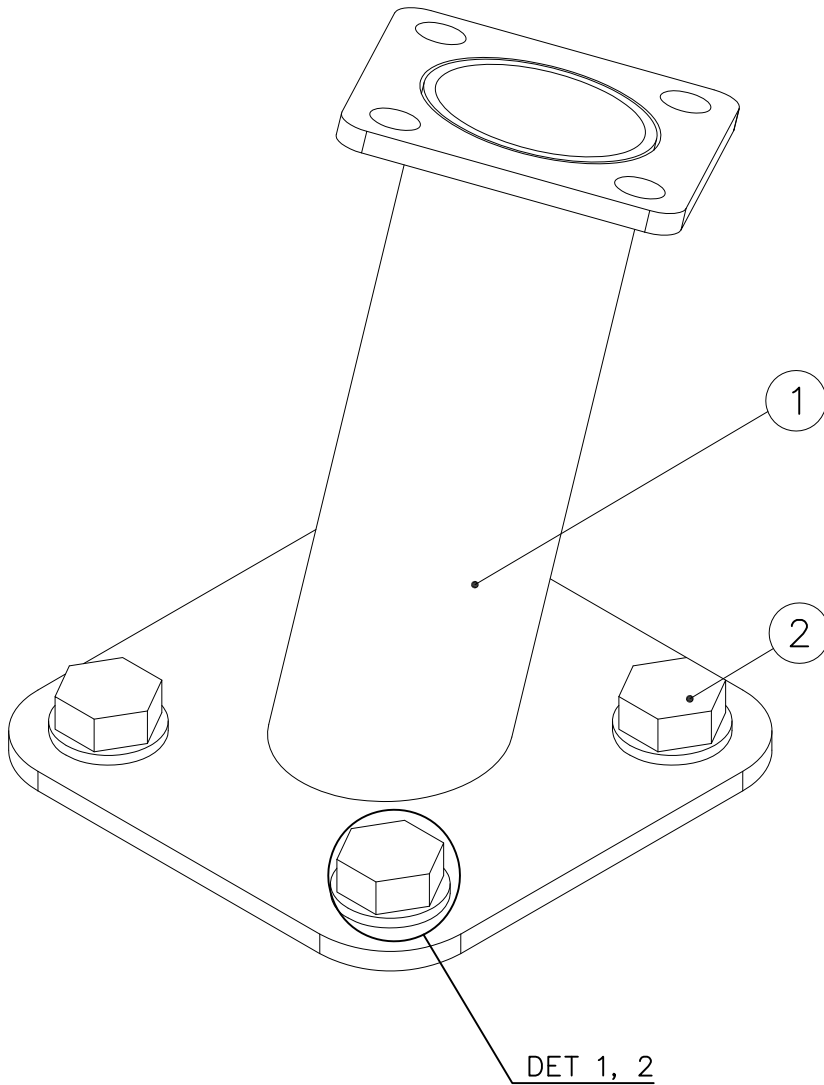

① 929550	PCS	① 929551	PCS
	1		1
RIGHT		LEFT	
	PCS		PCS
	PCS		PCS
	PCS		PCS
② 909520	PCS	③ 929426	PCS
	4		4
Ø30/17		M16x100	
④ 929914	PCS		PCS
	4		
M16x110			

DET 1

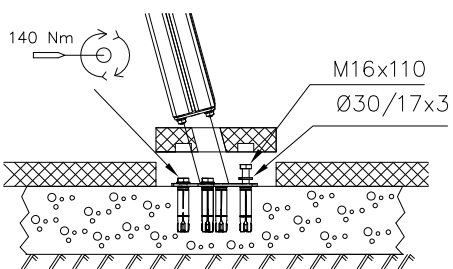

DET 2

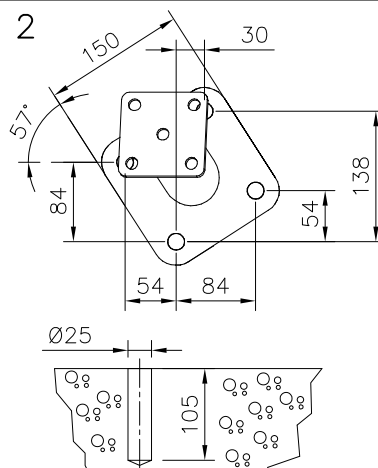

DET 3

**Tuotekyltti tulee tuotteen mukana yhdellä seuraavista tavoista:****1) Metallinen tuotekyltti ja kiinnitysruuvit**

- Kiinnitä tuotekyltti ruuveilla tolppaan noin 2 metrin korkeuteen kuvan 1 mukaisesti.

2) Tuotekyltitarra

- Puhdista maalattu metalli- tai vaneripinta pölystä ja kosteudesta. Liimaa tarra kuvan 2 mukaisesti.
- Huom. Älä kiinnitä tarraa karheapintaiseen laminaattiin tai maalattuun puuhun.

Vår produktmärkning levereras på ett av följande sätt:**1) Produktskylt i metall**

- Fäst skylten med de medföljande skruvarna

2) Självhäftande produktetikett

- Rengör den pulverlackerade metallytan eller laminatyten så att den blir fri från smuts och fukt. Fäst etiketten enligt fig. 2.
- Obs! Fäst ej etiketten på detaljer med skrovlig yta eller på målat trä.

Product label is delivered by one of following ways:**1) Metal product label and screws**

- Fasten the label with screws.

2) Label sticker

- Clean the painted metal or plywood surface from dirt and moisture. Fasten the sticker as shown in the figure 2.
- Note. Do not attach the sticker to rough surfaced laminate or painted wood.

La plaque d'informations produit est livrée sous l'une de ces 3 formes :**1) Plaque métallique et vis**

- Fixez la plaque à l'aide des vis.

2) Etiquette autocollante

- Avant de coller l'étiquette, nettoyez le composant métallique peint ou la plaque de contreplaqué, de toute saleté. La surface doit être sèche (voir image 2).
- Attention, ne pas coller l'étiquette sur une surface lamellé-collée irrégulière ou sur du bois peint.

Die Auslieferung des Produktaufklebers erfolgt auf eine dieser Arten:**1) Produkt-Schild aus Metall incl. Schrauben**

- Die Befestigung des Schildes erfolgt mittels der Schrauben.

2) Aufkleber

- Entfernen Sie zunächst Schmutz und Feuchtigkeit vom lackierten Metall bzw. von der Holzoberfläche und bringen Sie den Aufkleber wie im Bild oben rechts beschrieben auf den gesäuberten Untergrund auf.
- Beachten Sie: Bringen Sie den Aufkleber nicht auf raues laminiertes oder lackiertes Holz an.