

LAPPSET®

FLORA







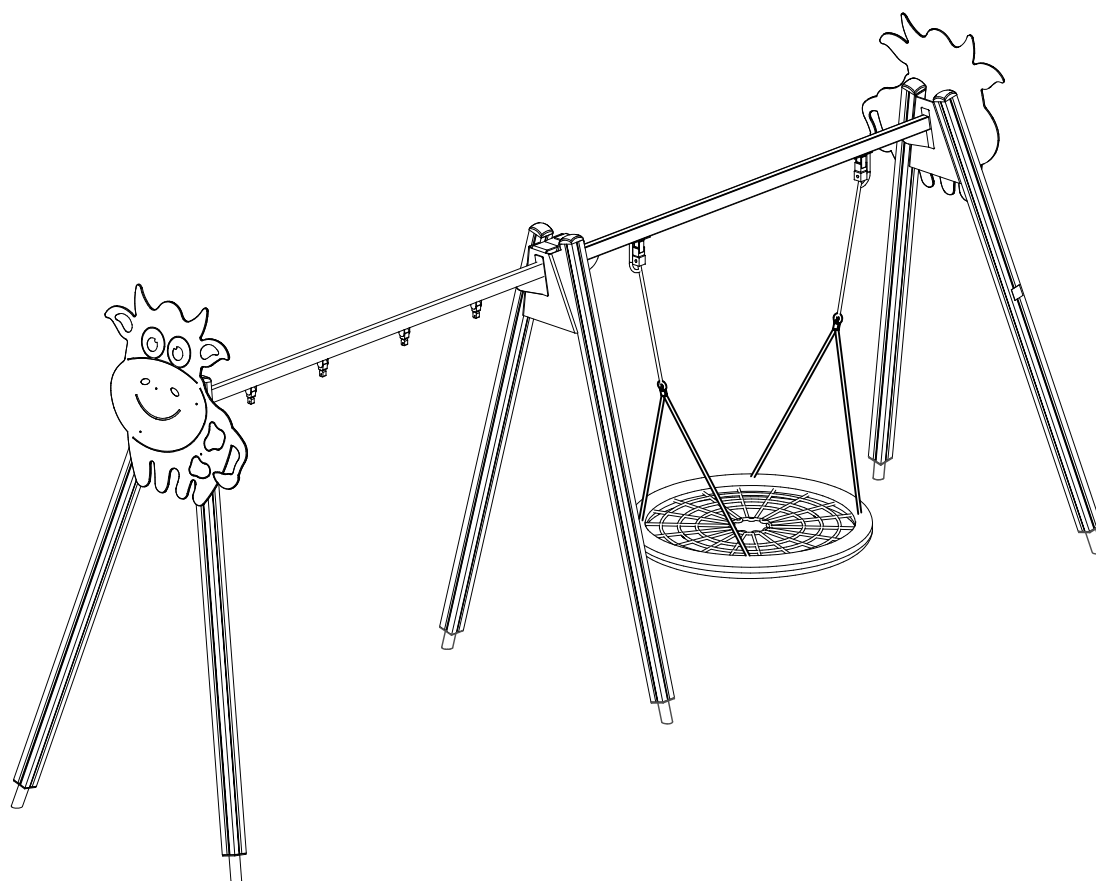



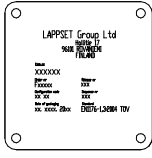

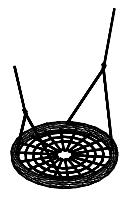
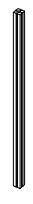

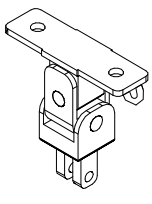
ASENNUSOHJE
MONTERINGSANSVISNING
INSTALLATION INSTRUCTION
AUFBAUANLEITUNG
NOTICE D'INSTALLATION

DATE: 21.11.2022

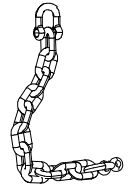
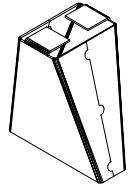
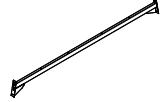
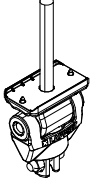
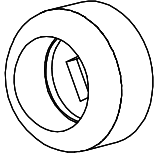
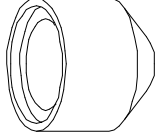
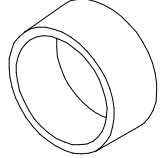
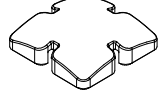
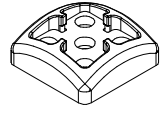
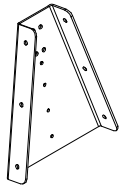
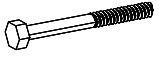
Q16831

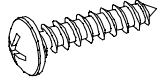
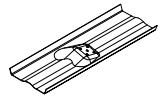
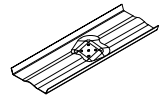
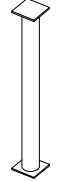
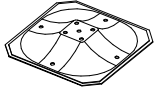
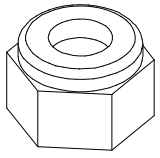
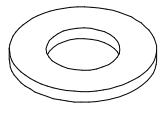
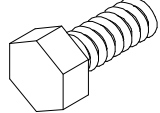
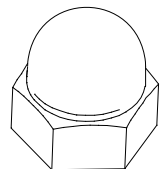
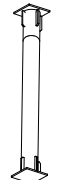
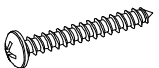
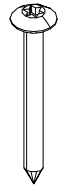
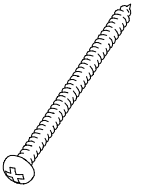

DATE: 21.11.2022

| | | | | | | | | | | | |
|---|----------|---|-----------|---|-----------|---|-----------|---|-----------|---|----------|
| 702286  65x65 | PCS 1 | 702533  118x78 | PCS 1 | 703248  | PCS 1 | 706564 FLORA  L2650 | PCS 6 | 900965  M10 | PCS 8 | 901958  | PCS 2 |
| 901959  L2940 | PCS 1 | 902234  M12 | PCS 4 | 903149  M12x30 | PCS 8 | 903577  | PCS 2 | 904317  | PCS 1 | 904333  L2940 | PCS 1 |
| 904904  | PCS 4 | 905090  Ø45 | PCS 18 | 905104  M10 | PCS 24 | 905115  Ø30 | PCS 18 | 905138  | PCS 6 | 905196  | PCS 6 |
| 905991  | PCS 2 | 906499  M12x110 | PCS 4 | 909347  M12x35 | PCS 18 | 909506  Ø3.5x13 | PCS 4 | 909507  | PCS 2 | 909508  | PCS 2 |
| 909511  L650 | PCS 2 | 909519  50x380x380 | PCS 2 | 909637  M10 | PCS 24 | 909638  Ø20/10.5 | PCS 64 | 909639  M10x25 | PCS 32 | 909644  M12 | PCS 8 |
| 911155  L650 | PCS 4 | 980114  Ø4x20 | PCS 4 | 980128  Ø7x40 | PCS 8 | 980131  Ø6x60 | PCS 24 | 980154  Ø24x13 | PCS 42 | 999561  GLUE 4101 ergo 10 g 10g | PCS 1 |
| P11964  | PCS 2 | | PCS | | PCS | | PCS | | PCS | | PCS |

EN/AS Impact Area 43.1 m²

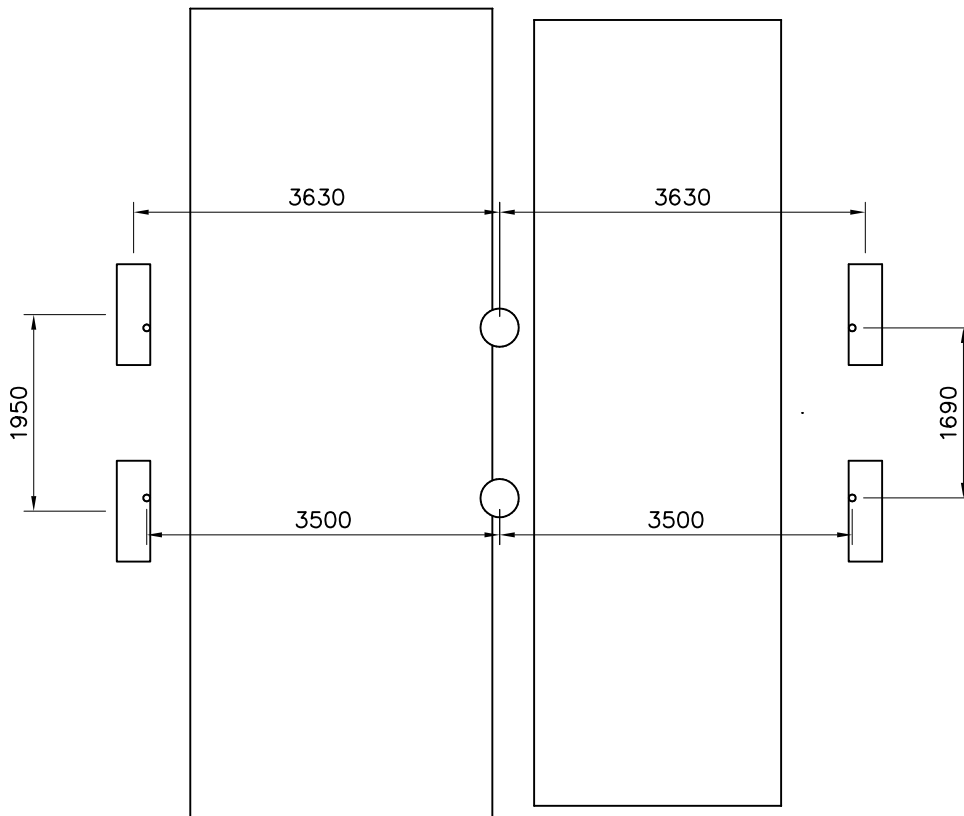
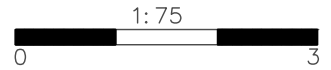

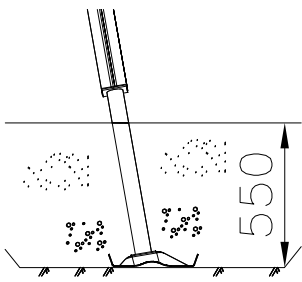
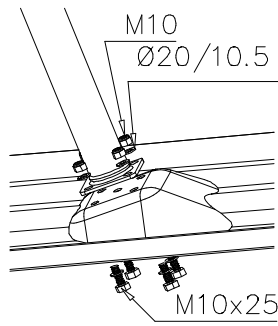
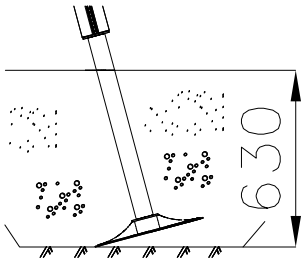
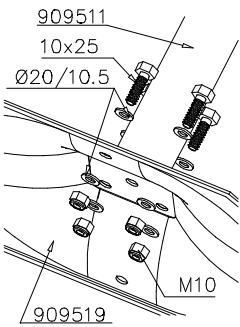
| | | |
|--|---|---|
|  |  |  |
|  | | |
| | | |
| | | |

- EN/AS Impact Area 43.1 m²
- - - - Falling Space 43.1 m²
- Max Falling Height 1400 mm

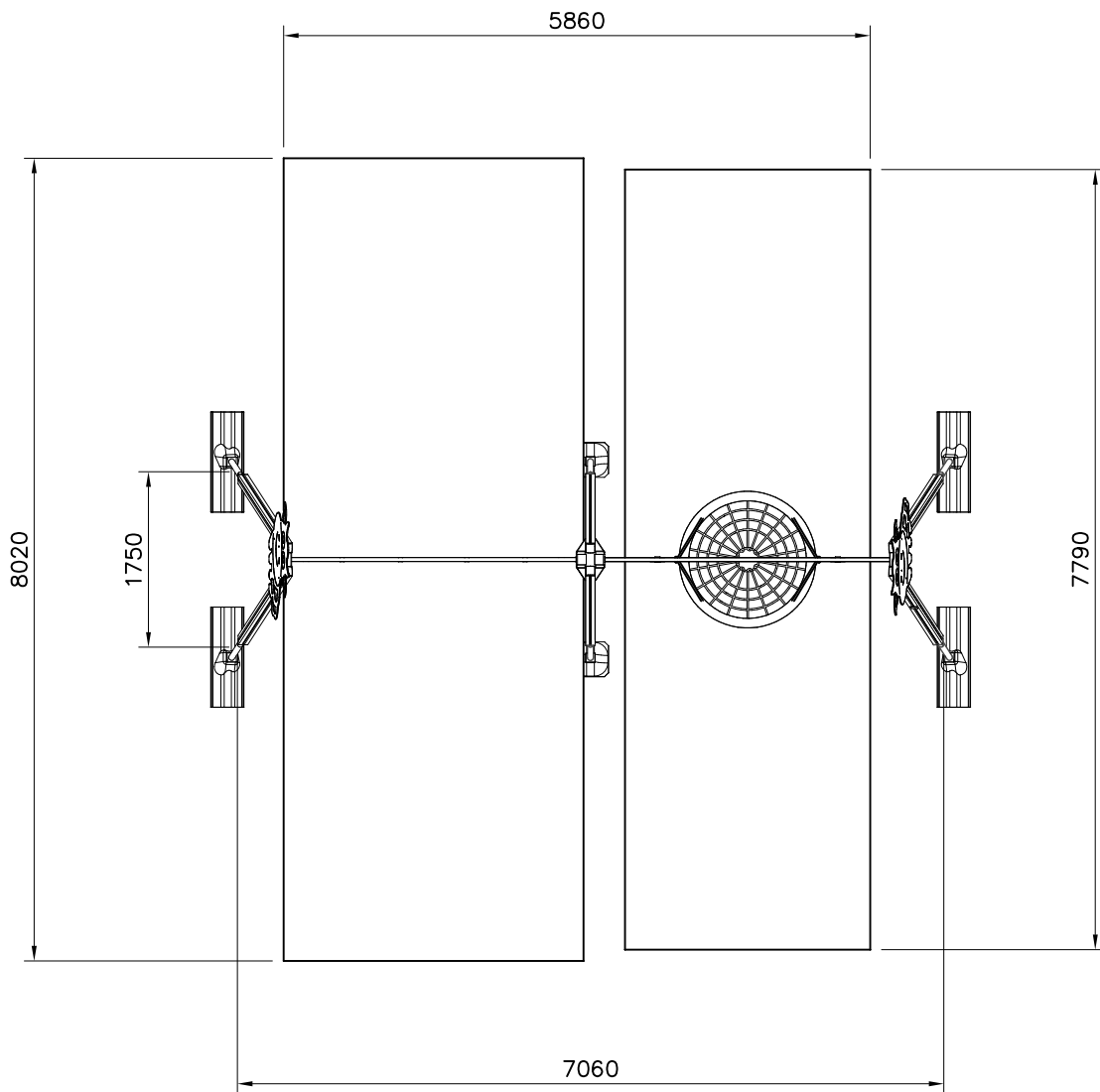
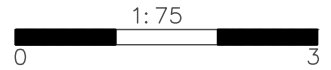

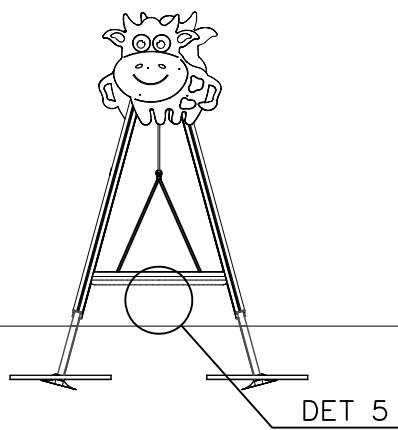
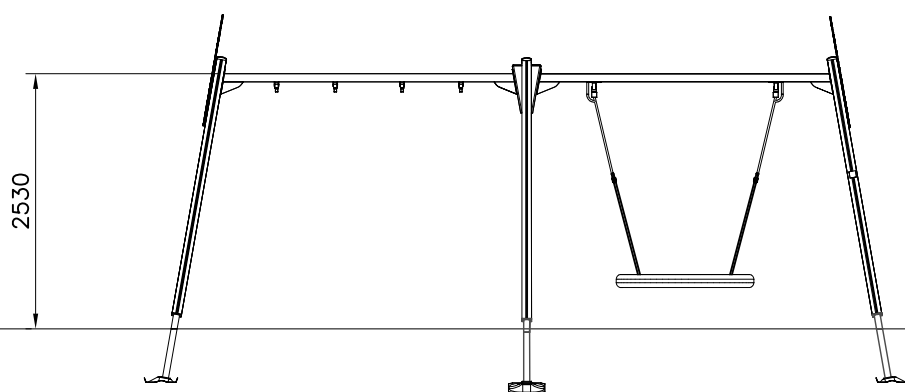

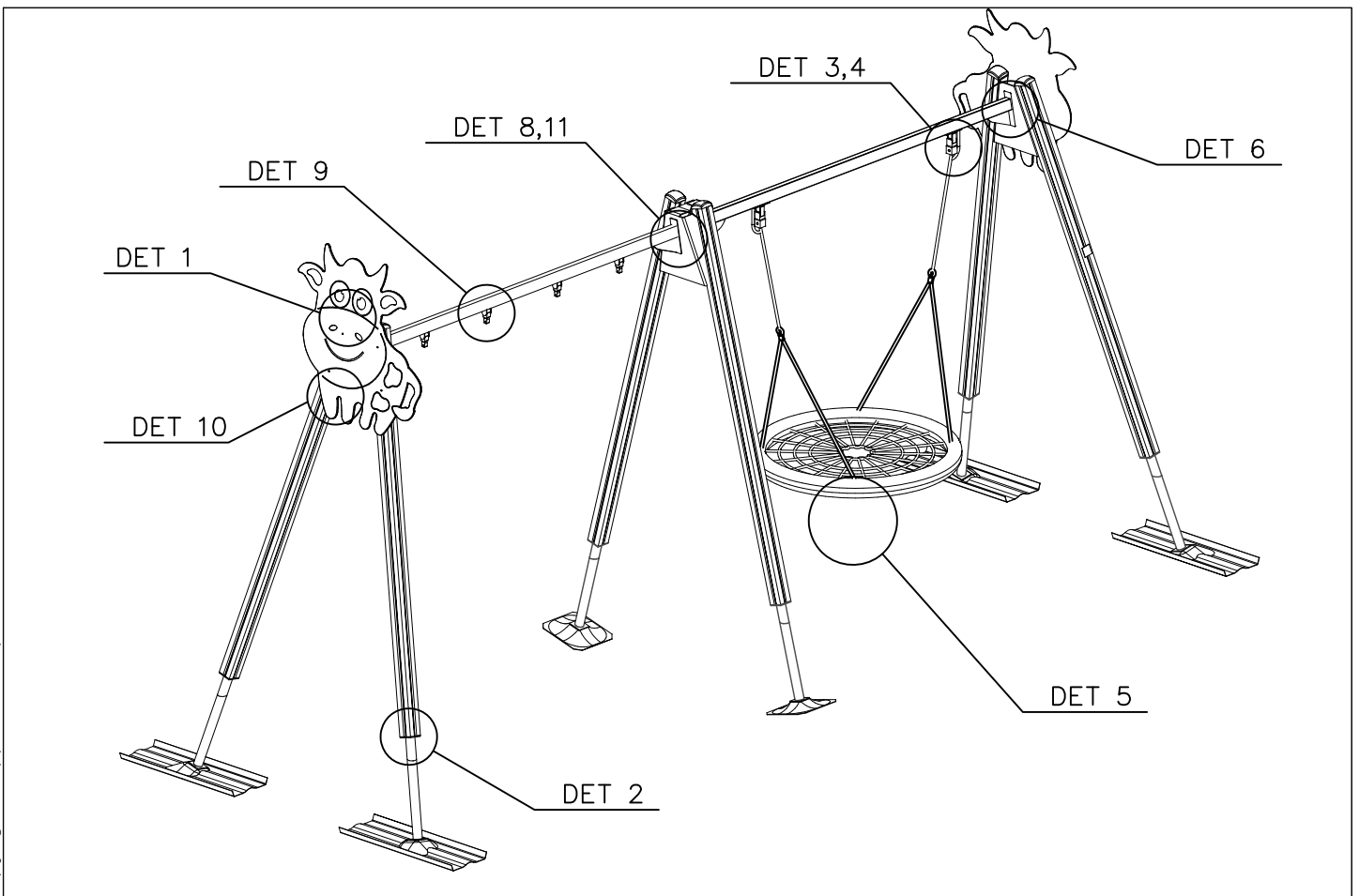
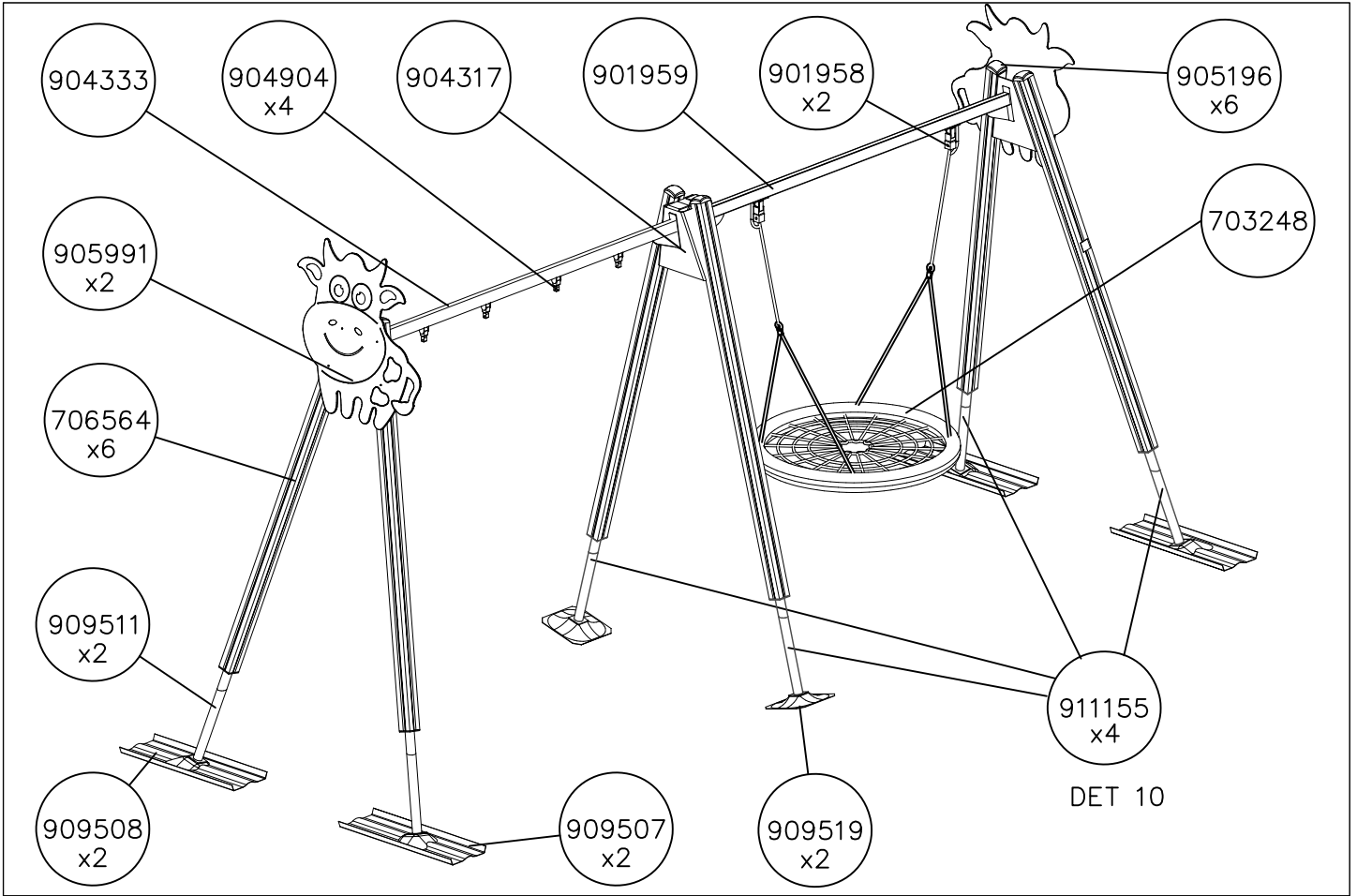

| | | | |
|---|---|---|--|
| <p>DET 1</p> <p>6x60 980131</p> | <p>DET 2</p> <p>M10 905104 909521</p> | <p>DET 3</p> <p>901958 903577</p> | <p>DET 4</p> <p>M12x110 Ø24/13 901958 M8x35 M12 M8 CUT EXTRA CHAIN</p> |
| <p>DET 5</p> <p>>400</p> | <p>DET 6</p> <p>911155</p> | <p>DET 7</p> <p>M12 → 80 Nm Ø24/13 M12x30 M12 M10x25 Ø20/10.5 M10 M10 → 45 Nm</p> | <p>DET 8</p> <p>904317</p> |
| <p>DET 9</p> <p>M12 90Nm 980154 Ø24/13 904904</p> | <p>DET 10</p> <p>Ø7x40</p> | <p>DET 11</p> <p>999561 GLUE Ø24/13 12x35 905115 905090</p> | |
| | | | |
| | | | |

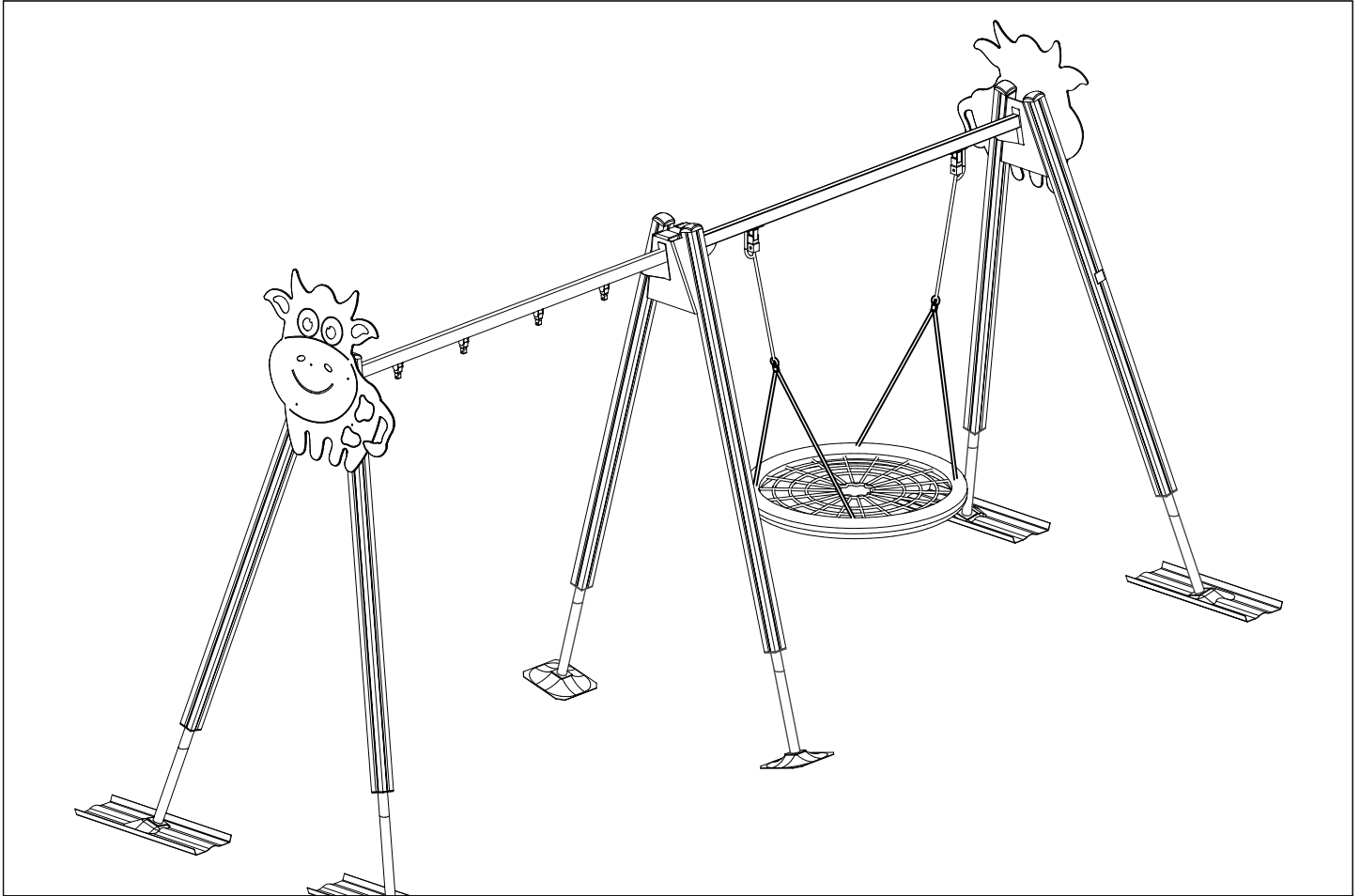

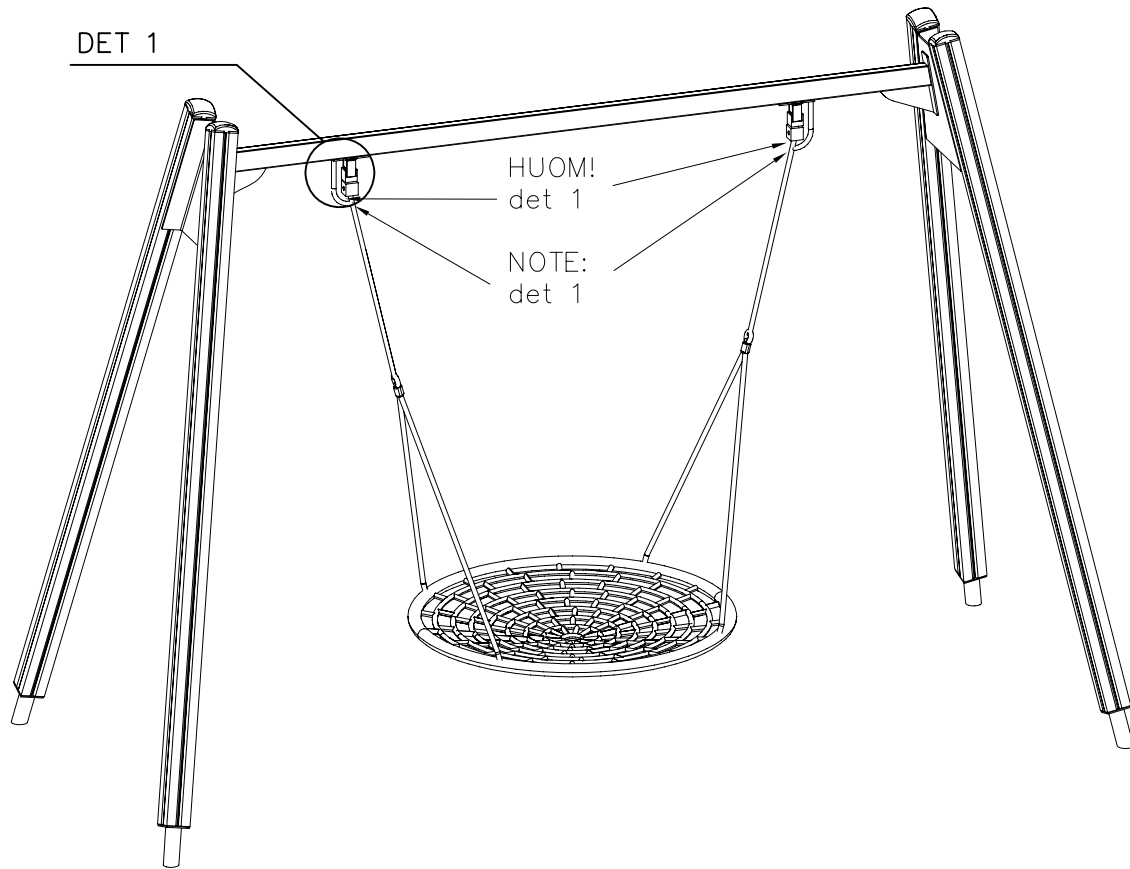

DET 1

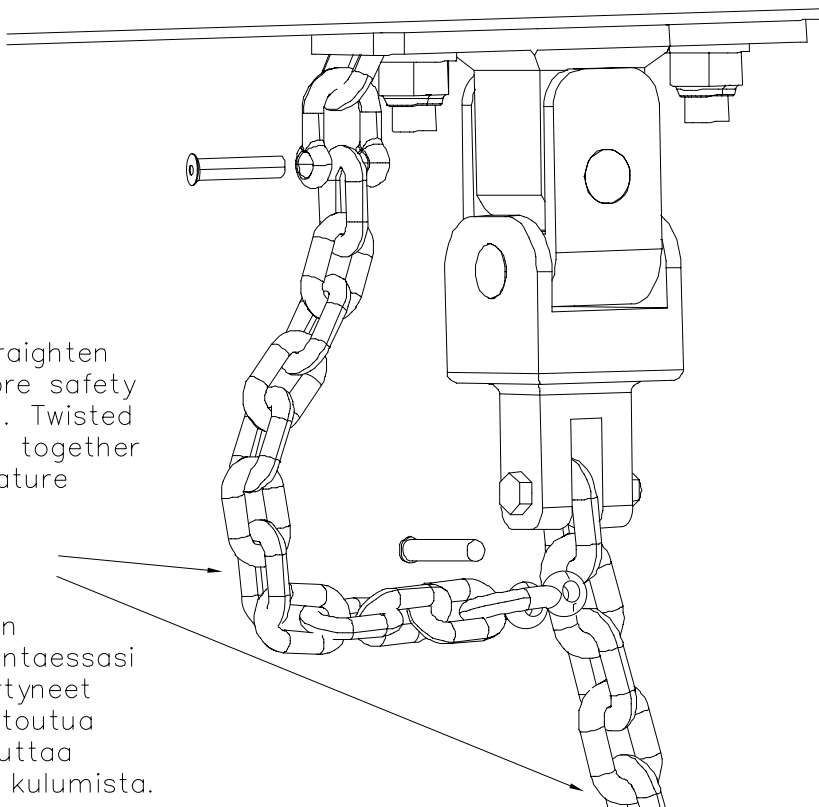

Note:
Make sure to straighten
both chains before safety
chain is installed. Twisted
chains may wrap together
and cause premature
wear.

Huom!
Varmistu ketjujen
suoruudesta asentaessasi
turvaketjua. Kiertyneet
ketjut voivat kietoutua
toisiinsa ja aiheuttaa
ketjujen nopeaa kulumista.

LAPPSET®
BETON FOUNDATION

FOOT

DATE: 27.10.2015

1(1)

| | | | |
|--|-----|--|-----|
| ② 905104 | PCS | | PCS |
| | 4 | | |
|  M10 | PCS | | PCS |
| | | | |



905104



Tuotekyltti tulee tuotteen mukana yhdellä seuraavista tavoista:

1) Metallinen tuotekyltti ja kiinnitysruuvit

- Kiinnitä tuotekyltti ruuveilla tolppaan noin 2 metrin korkeuteen kuvan 1 mukaisesti.

2) Tuotekylttitarra

- Puhdista maalattu metalli- tai vaneripinta pölystä ja kosteudesta. Liimaa tarra kuvan 2 mukaisesti.
- Huom. Älä kiinnitä tarraa karheapintaiseen laminaattiin tai maalattuun puuhun.

Vår produktmärkning levereras på ett av följande sätt:

1) Produktskylt i metall

- Fäst skylten med de medföljande skruvarna

2) Självhäftande produktetikett

- Rengör den pulverlackerade metallytan eller laminatyten så att den blir fri från smuts och fukt. Fäst etiketten enligt fig. 2.
- Obs! Fäst ej etiketten på detaljer med skrovlig yta eller på målat trä.

Product label is delivered by one of following ways:

1) Metal product label and screws

- Fasten the label with screws.

2) Label sticker

- Clean the painted metal or plywood surface from dirt and moisture. Fasten the sticker as shown in the figure 2.
- Note. Do not attach the sticker to rough surfaced laminate or painted wood.

La plaque d'informations produit est livrée sous l'une de ces 3 formes :

1) Plaque métallique et vis

- Fixez la plaque à l'aide des vis.

2) Etiquette autocollante

- Avant de coller l'étiquette, nettoyez le composant métallique peint ou la plaque de contreplaqué, de toute saleté. La surface doit être sèche (voir image 2).
- Attention, ne pas coller l'étiquette sur une surface lamellé-collée irrégulière ou sur du bois peint.

Die Auslieferung des Produktaufklebers erfolgt auf eine dieser Arten:

1) Produkt-Schild aus Metall incl. Schrauben

- Die Befestigung des Schildes erfolgt mittels der Schrauben.

2) Aufkleber

- Entfernen Sie zunächst Schmutz und Feuchtigkeit vom lackierten Metall bzw. von der Holzoberfläche und bringen Sie den Aufkleber wie im Bild oben rechts beschrieben auf den gesäuberten Untergrund auf.
- Beachten Sie: Bringen Sie den Aufkleber nicht auf raues laminiertes oder lackiertes Holz an.