

LAPPSET®

FLORA







ASENNUSOHJE
MONTERINGSANSVISNING
INSTALLATION INSTRUCTION
AUFBAUANLEITUNG
NOTICE D'INSTALLATION

DATE: 1.12.2022

Q15668-7

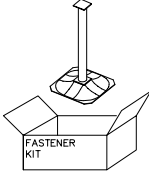
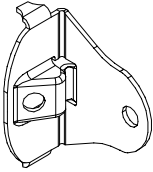
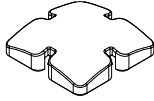
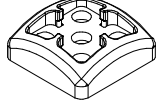
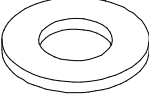
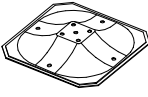
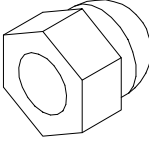

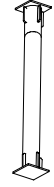
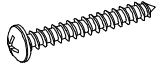
DATE: 16.11.2022

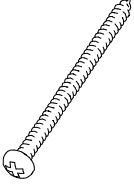
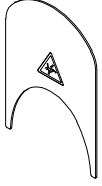
702286	PCS	706484-603	PCS	706531	PCS	903176	PCS	905138	PCS	905196	PCS
	1		2		2		4		2		2
65x65		93x93x2150						GRAY		GRAY	
909256	PCS	909519	PCS	909633	PCS	909852	PCS	911155	PCS	980114	PCS
	4		2		4		4		2		4
Ø16/8.4x1.6		50x380x380		M8		M8x30		90x90x650		Ø4x20	
980123	PCS	980131	PCS	P03287	PCS		PCS		PCS		PCS
	4		8		1						
Ø7x60		Ø6x60		15x900x1100							
	PCS		PCS		PCS		PCS		PCS		PCS
	PCS		PCS		PCS		PCS		PCS		PCS
	PCS		PCS		PCS		PCS		PCS		PCS
	PCS		PCS		PCS		PCS		PCS		PCS

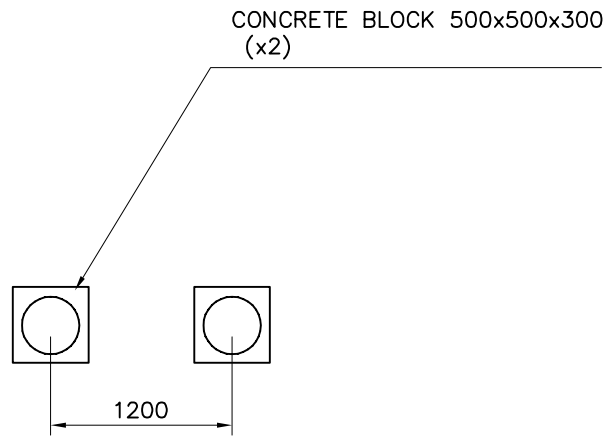

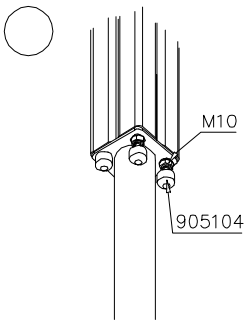
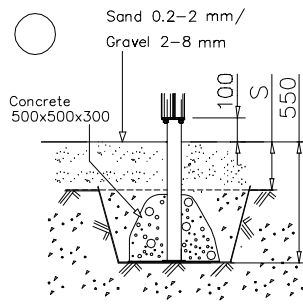

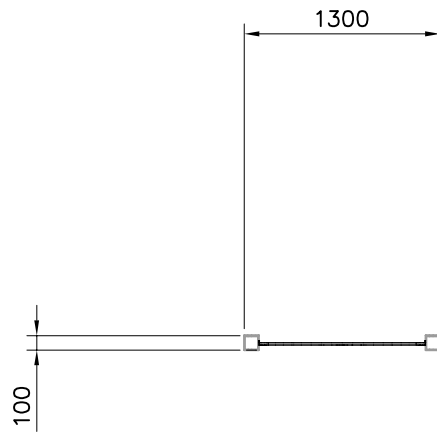
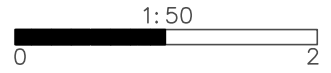

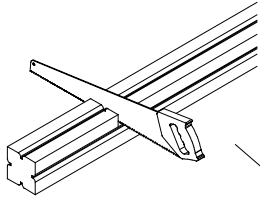

Height/posititon
of the plate
P03287
depends on
the tube slide.
Cut off the
extra length
of the posts
when plate is
fixed.

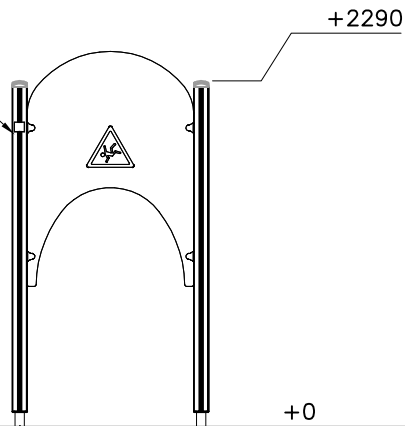

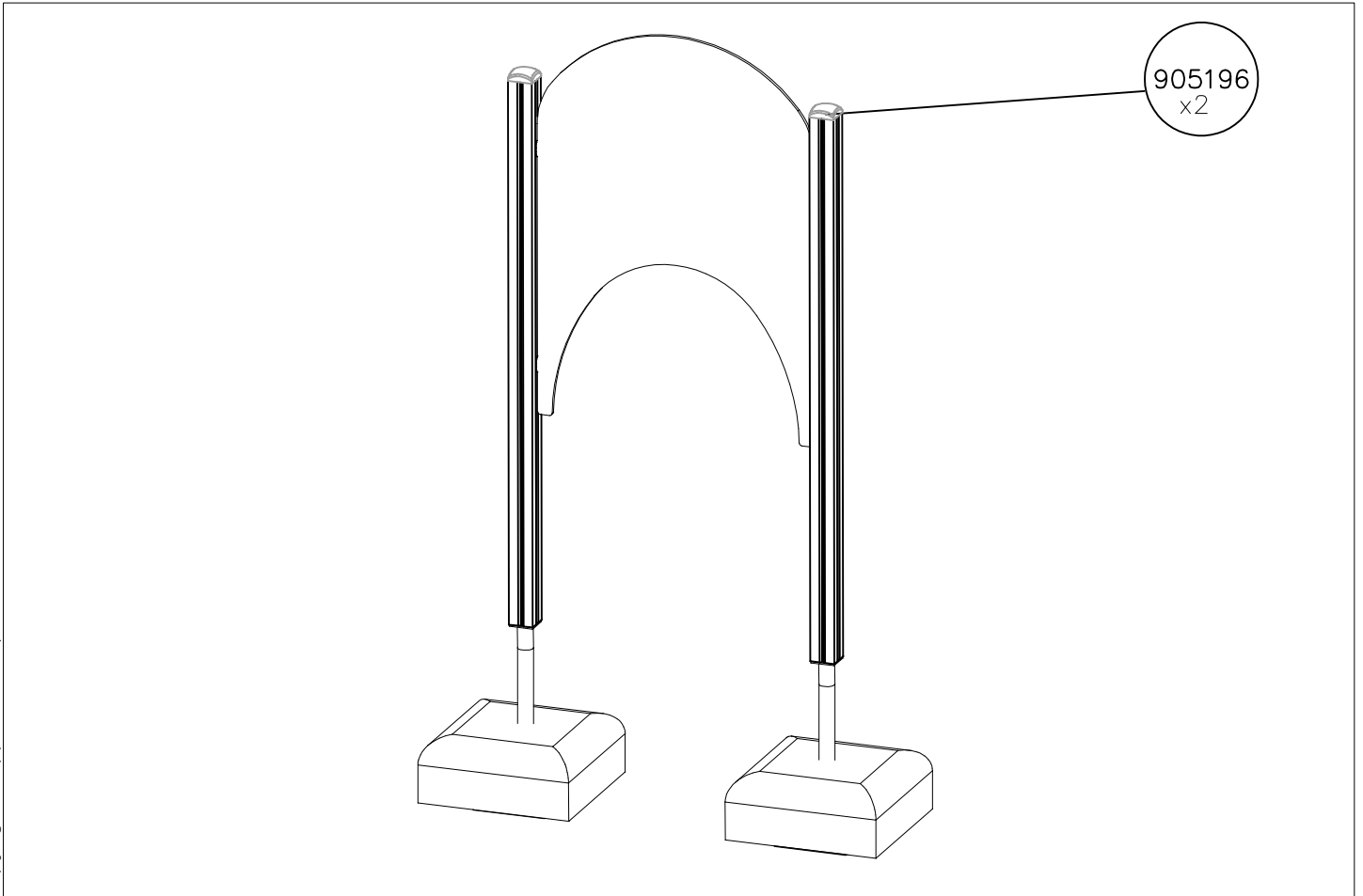
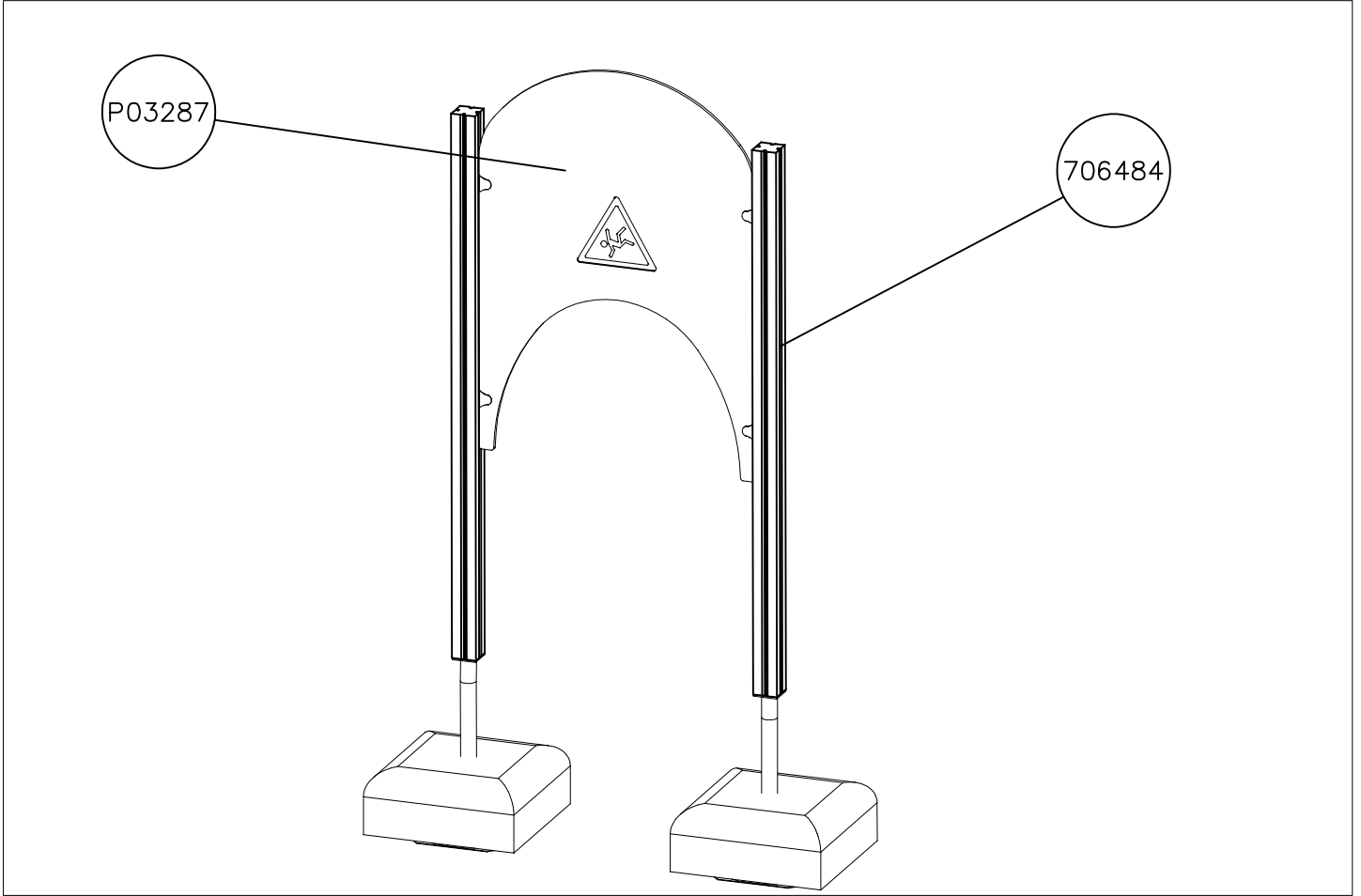

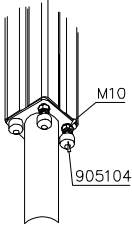
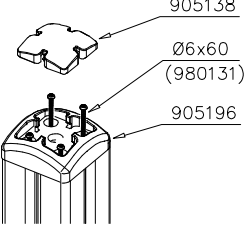
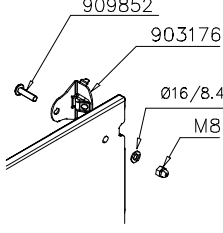
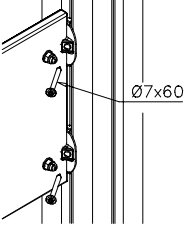
<p>DET 1</p> 	<p>DET 2</p> 	<p>DET 3</p> 	<p>DET 4</p> 

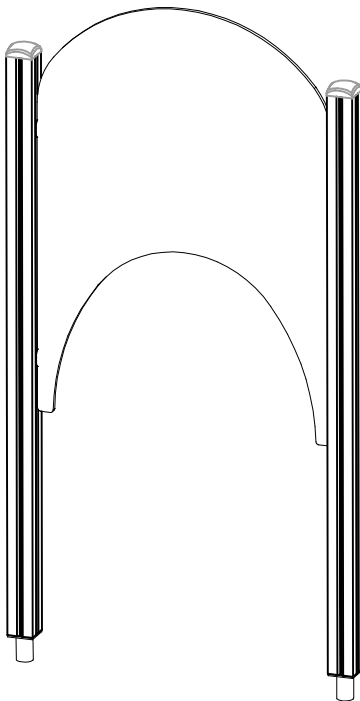
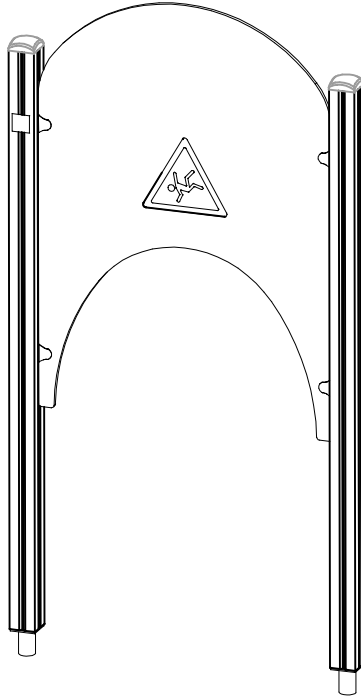



Tuotekyltti tulee tuotteen mukana yhdellä seuraavista tavoista:

1) Metallinen tuotekyltti ja kiinnitysruuvit

- Kiinnitä tuotekyltti ruuveilla tolppaan noin 2 metrin korkeuteen kuvan 1 mukaisesti.

2) Tuotekylttitarra

- Puhdista maalattu metalli- tai vaneripinta pölystä ja kosteudesta. Liimaa tarra kuvan 2 mukaisesti.
- Huom. Älä kiinnitä tarraa karheapintaiseen laminaattiin tai maalattuun puuhun.

Vår produktmärkning levereras på ett av följande sätt:

1) Produktskylt i metall

- Fäst skylten med de medföljande skruvarna

2) Självhäftande produktetikett

- Rengör den pulverlackerade metallytan eller laminatyten så att den blir fri från smuts och fukt. Fäst etiketten enligt fig. 2.
- Obs! Fäst ej etiketten på detaljer med skrovlig yta eller på målat trä.

Product label is delivered by one of following ways:

1) Metal product label and screws

- Fasten the label with screws.

2) Label sticker

- Clean the painted metal or plywood surface from dirt and moisture. Fasten the sticker as shown in the figure 2.
- Note. Do not attach the sticker to rough surfaced laminate or painted wood.

La plaque d'informations produit est livrée sous l'une de ces 3 formes :

1) Plaque métallique et vis

- Fixez la plaque à l'aide des vis.

2) Etiquette autocollante

- Avant de coller l'étiquette, nettoyez le composant métallique peint ou la plaque de contreplaqué, de toute saleté. La surface doit être sèche (voir image 2).
- Attention, ne pas coller l'étiquette sur une surface lamellé-collée irrégulière ou sur du bois peint.

Die Auslieferung des Produktaufklebers erfolgt auf eine dieser Arten:

1) Produkt-Schild aus Metall incl. Schrauben

- Die Befestigung des Schildes erfolgt mittels der Schrauben.

2) Aufkleber

- Entfernen Sie zunächst Schmutz und Feuchtigkeit vom lackierten Metall bzw. von der Holzoberfläche und bringen Sie den Aufkleber wie im Bild oben rechts beschrieben auf den gesäuberten Untergrund auf.
- Beachten Sie: Bringen Sie den Aufkleber nicht auf raues laminiertes oder lackiertes Holz an.

LAPPSET®
DEEP FOUNDATION

FOOT

DATE: 13.3.2014

4A



LAPPSET®
BETON FOUNDATION

FOOT

DATE: 27.10.2015

1(1)

② 905104	PCS		PCS
	4		
 M10	PCS		PCS



905104

LAPPSET® DEEP FOUNDATION

FOOT

DATE: 15.5.2018

1(1)



①	909511	PCS	②	909519	PCS
		1			1
	90x90x650			50x380x380	
③	909637	PCS	④	909638	PCS
		4			8
	M10			Ø20/10.5	
⑤	909639	PCS	⑥	905104	PCS
		4			4
	M10x25			M10	
OPTION FOOT					
①	911155	PCS			PCS
		1			
	90x90x650				