

# LAPPSET®

## ARENA





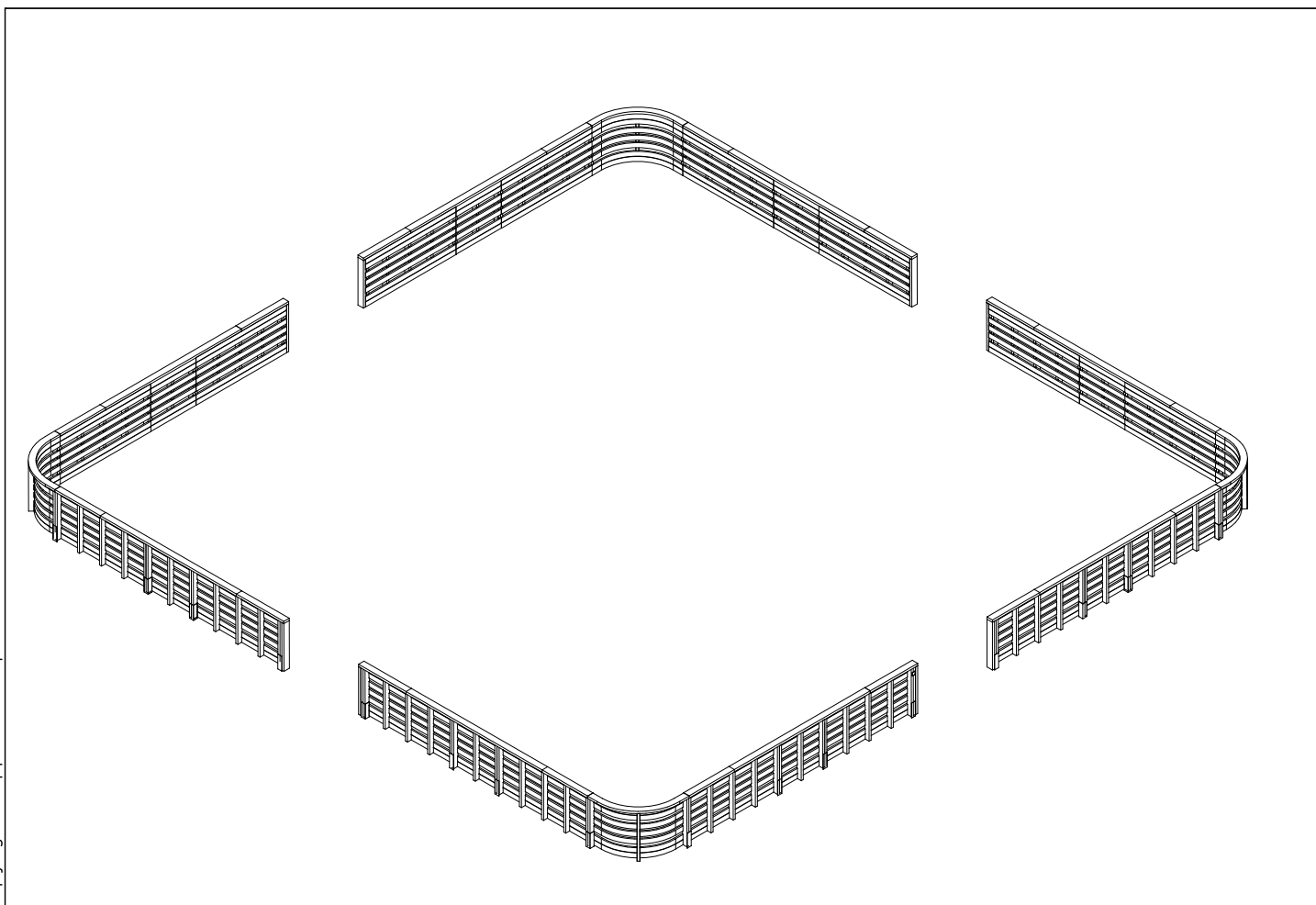

ASENNUSOHJE  
MONTERINGSANSVISNING  
INSTALLATION INSTRUCTION  
AUFBAUANLEITUNG  
NOTICE D'INSTALLATION

DATE: 8.3.2017

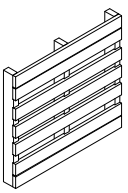
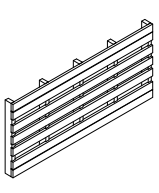
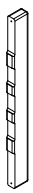
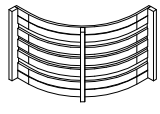
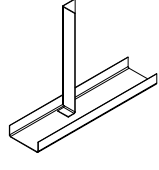
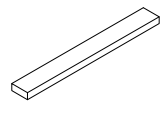
### Q10703

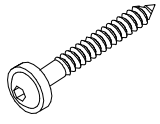
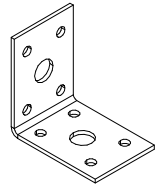
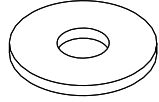
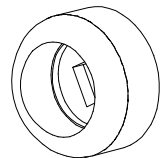
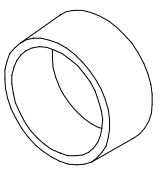

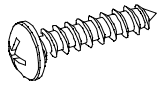
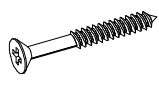
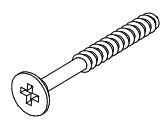
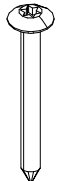
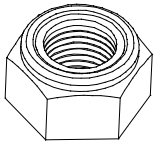
DATE: 3.3.2017

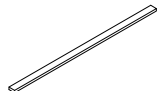
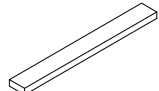
702019  L 1000	PCS 8	702021  L 2000	PCS 16	702022  L 910	PCS 8	702038  L 1000	PCS 4	702220  L 1000	PCS 32	702228  L 1000	PCS 8
702248 	PCS 4	702286  LAPPSET Group Ltd www.lappset.com Tel: +44 (0)1223 800000 Fax: +44 (0)1223 800001 E-mail: sales@lappset.com UK Office: Unit 10, Lymington Way, Lymington, Hampshire, SO41 1JG, UK	PCS 1	900240  Ø8x70	PCS 24	902434  Ø24/8,4	PCS 76	905051  Ø24/8,4	PCS 208	905090  Ø45	PCS 8
905115  Ø30	PCS 8	909148  M8x150	PCS 8	909203  M8x75	PCS 96	909506  Ø3.5x13	PCS 4	980103  Ø4x50	PCS 152	980107  Ø6x60	PCS 112
980128  Ø7x40	PCS 76	980150  M8	PCS 104	P00426  45x120x910	PCS 8	P01444  L 3000	PCS 8	P10826  L 1045	PCS 8		PCS
	PCS		PCS		PCS		PCS		PCS		PCS
	PCS		PCS		PCS		PCS		PCS		PCS
	PCS		PCS		PCS		PCS		PCS		PCS

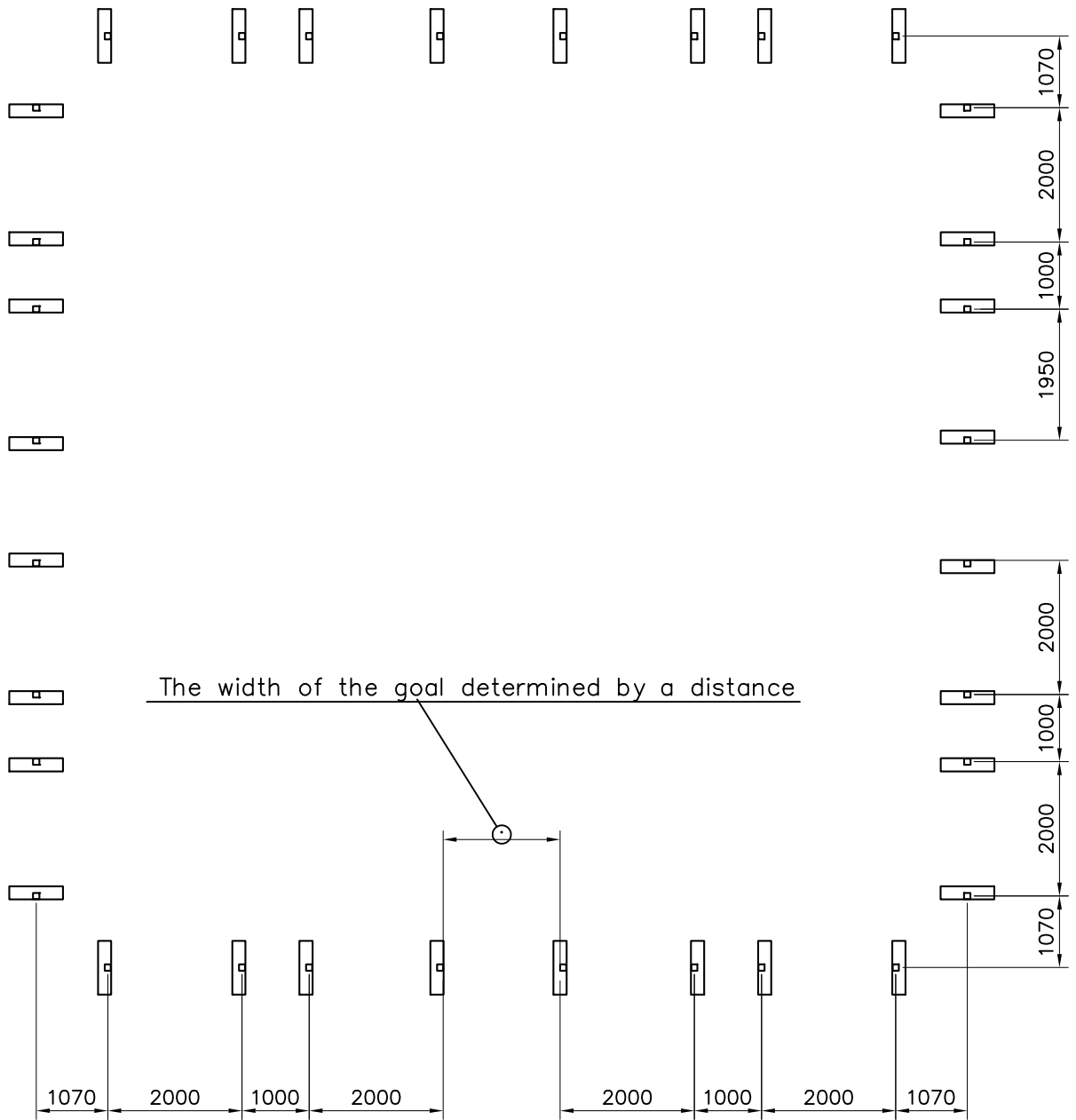
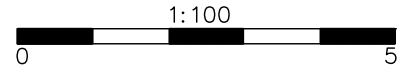

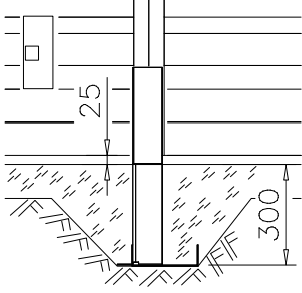
 <p>Technical drawing of a Lappset Arena Q10703 component. The drawing shows a cross-section of a vertical post or bracket. A dimension line indicates a height of 25 units from the top edge to the top of the main vertical section. Another dimension line indicates a width of 300 units for the base of the component. The base is shown with diagonal hatching, suggesting a specific material or finish. The component is shown in a perspective view, with a top-down view of the base.</p>		

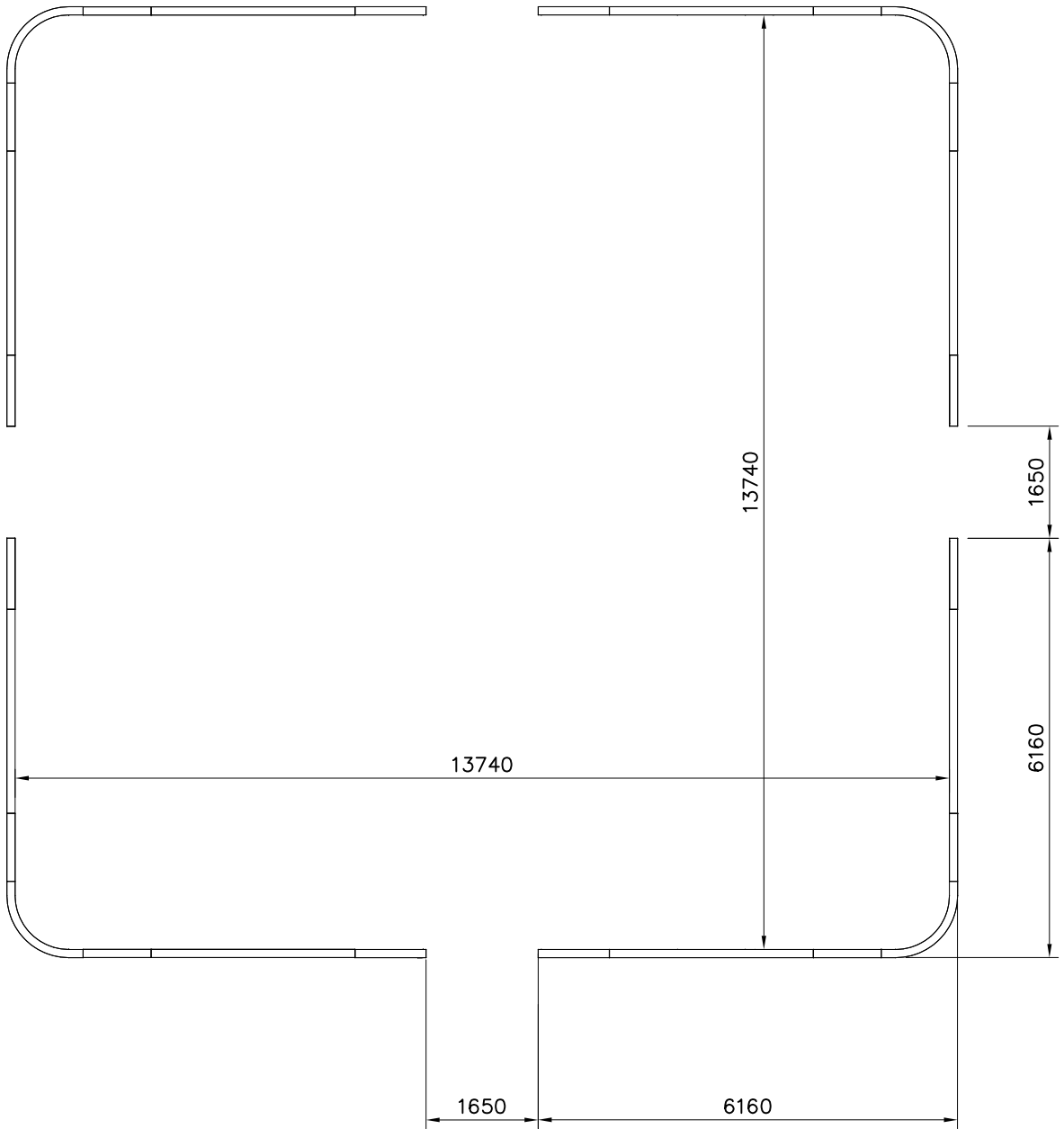
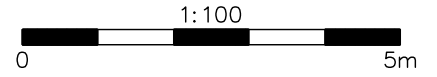

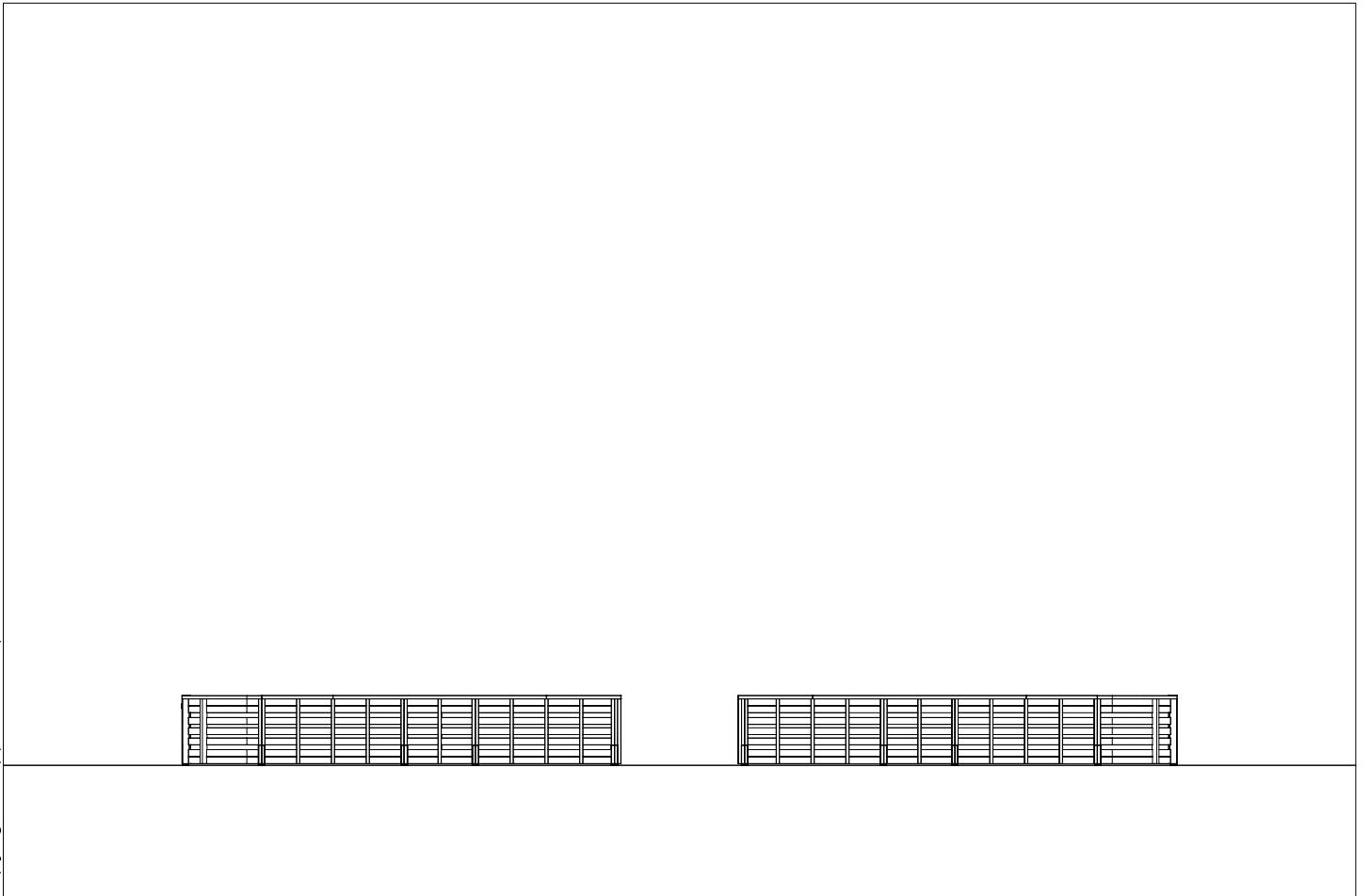
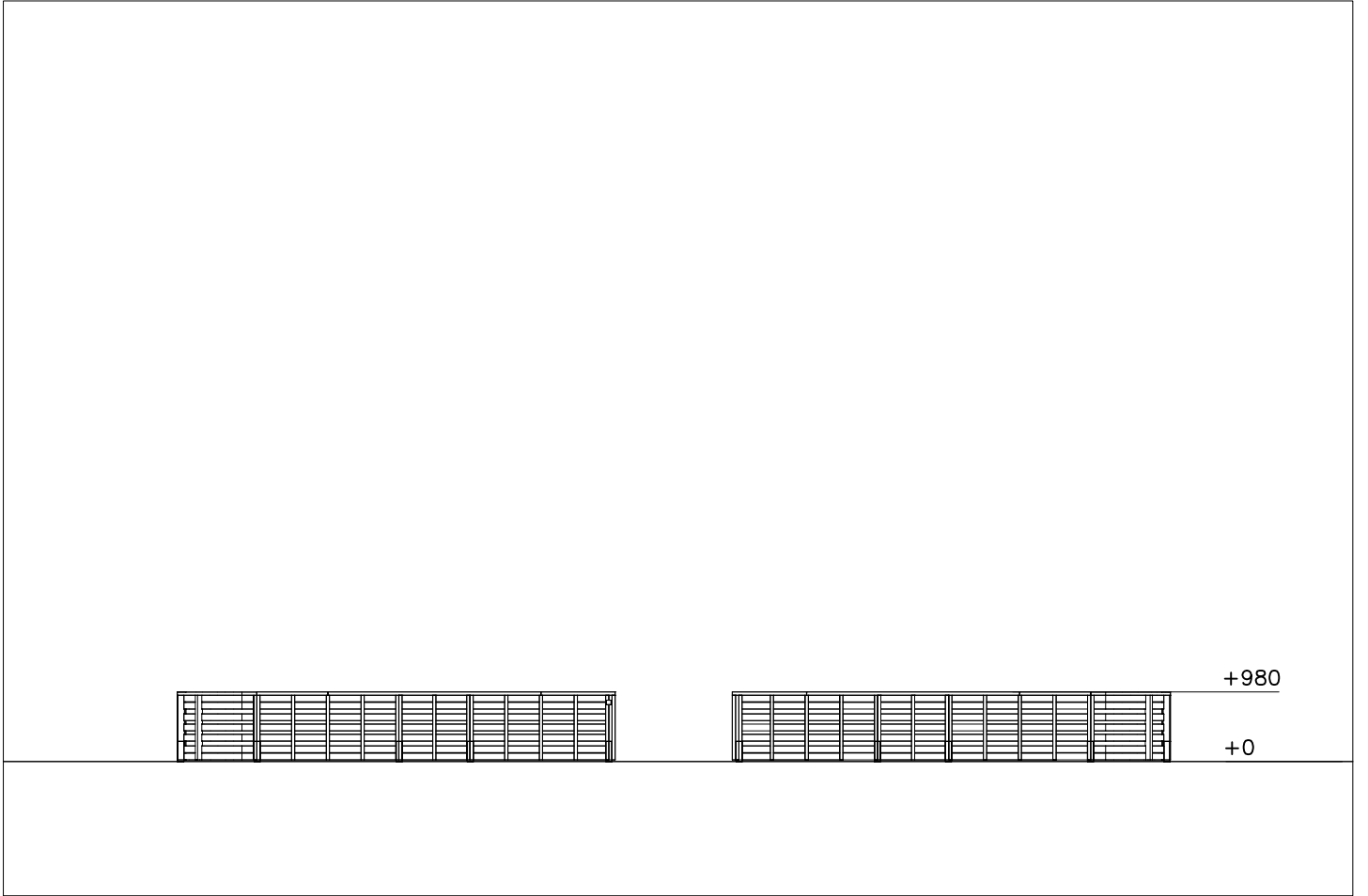

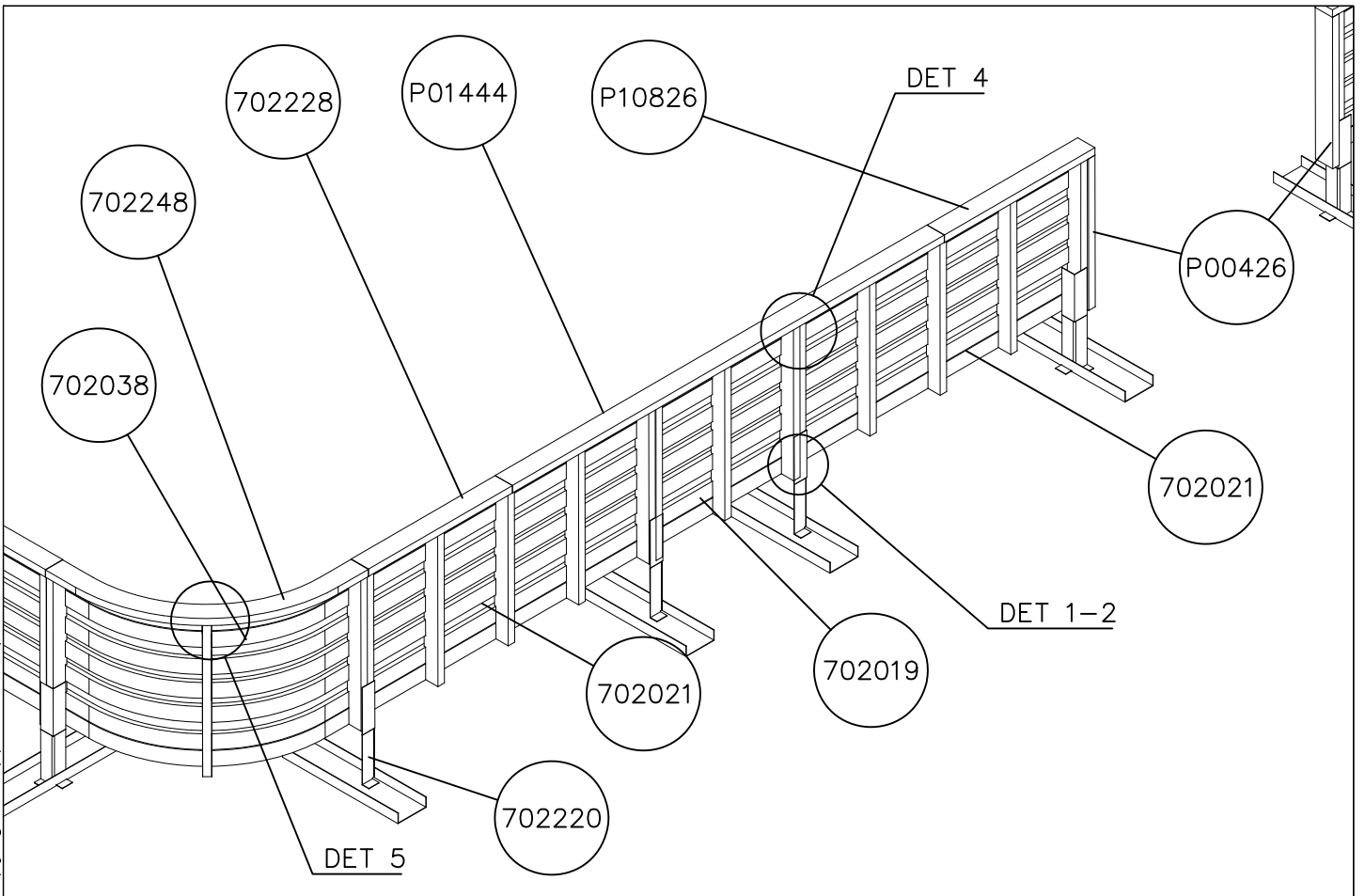
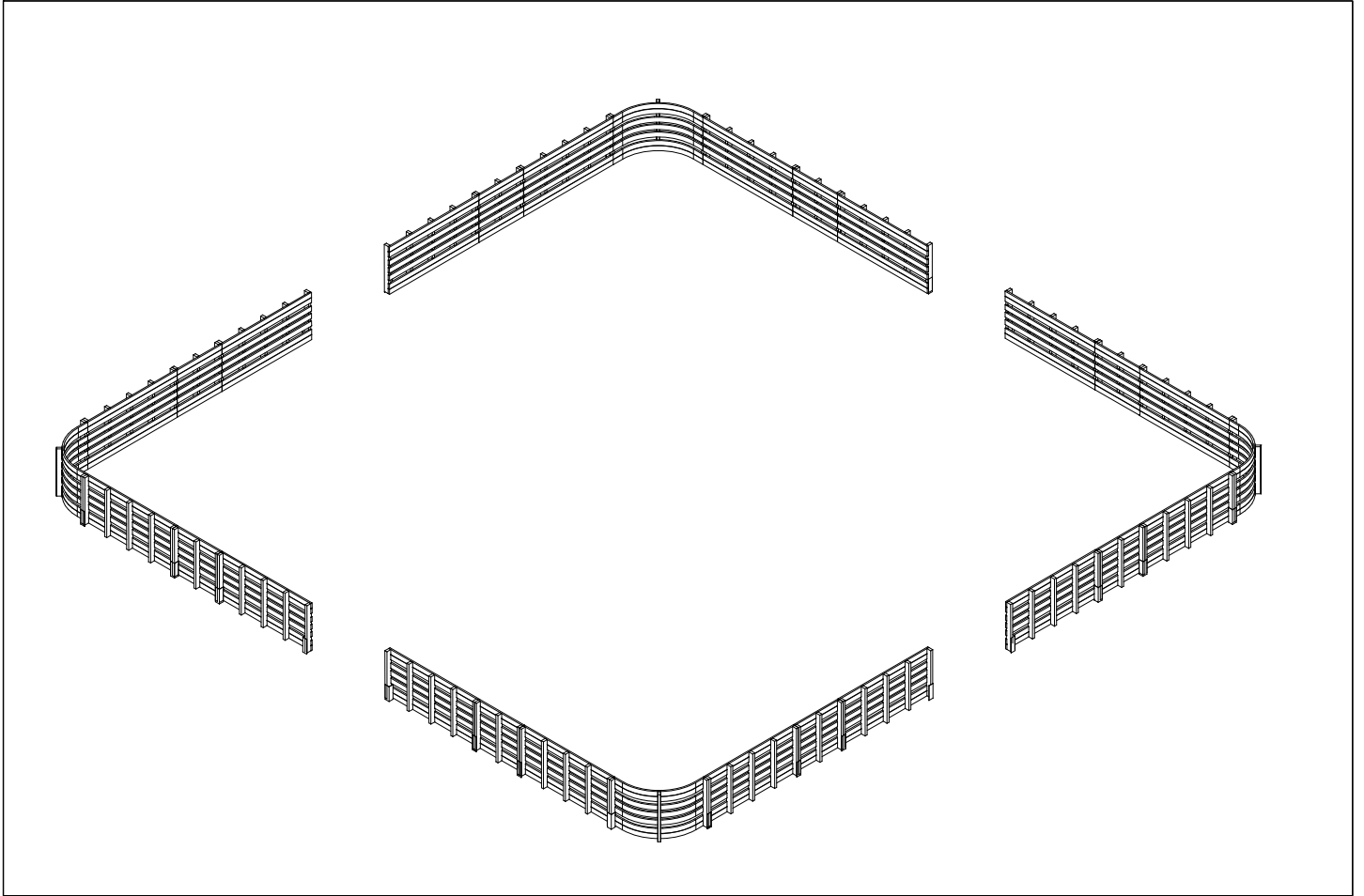

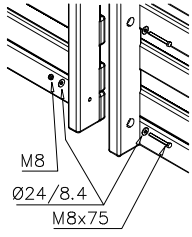
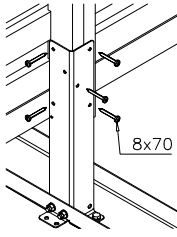
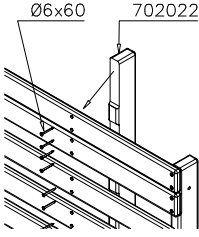
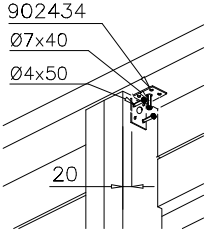
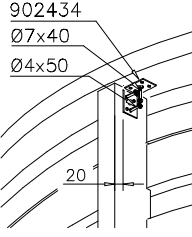
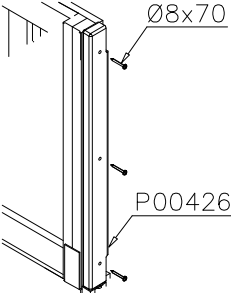

<p>DET 1</p>  <p>M8          Ø24/8.4          M8x75</p>	<p>DET 2</p>  <p>8x70</p>	<p>DET 3</p>  <p>Ø6x60          702022</p>	<p>DET 4</p>  <p>902434          Ø7x40          Ø4x50          20</p>
<p>DET 5</p>  <p>902434          Ø7x40          Ø4x50          20</p>	<p>DET 6</p>  <p>Ø8x70          P00426</p>		

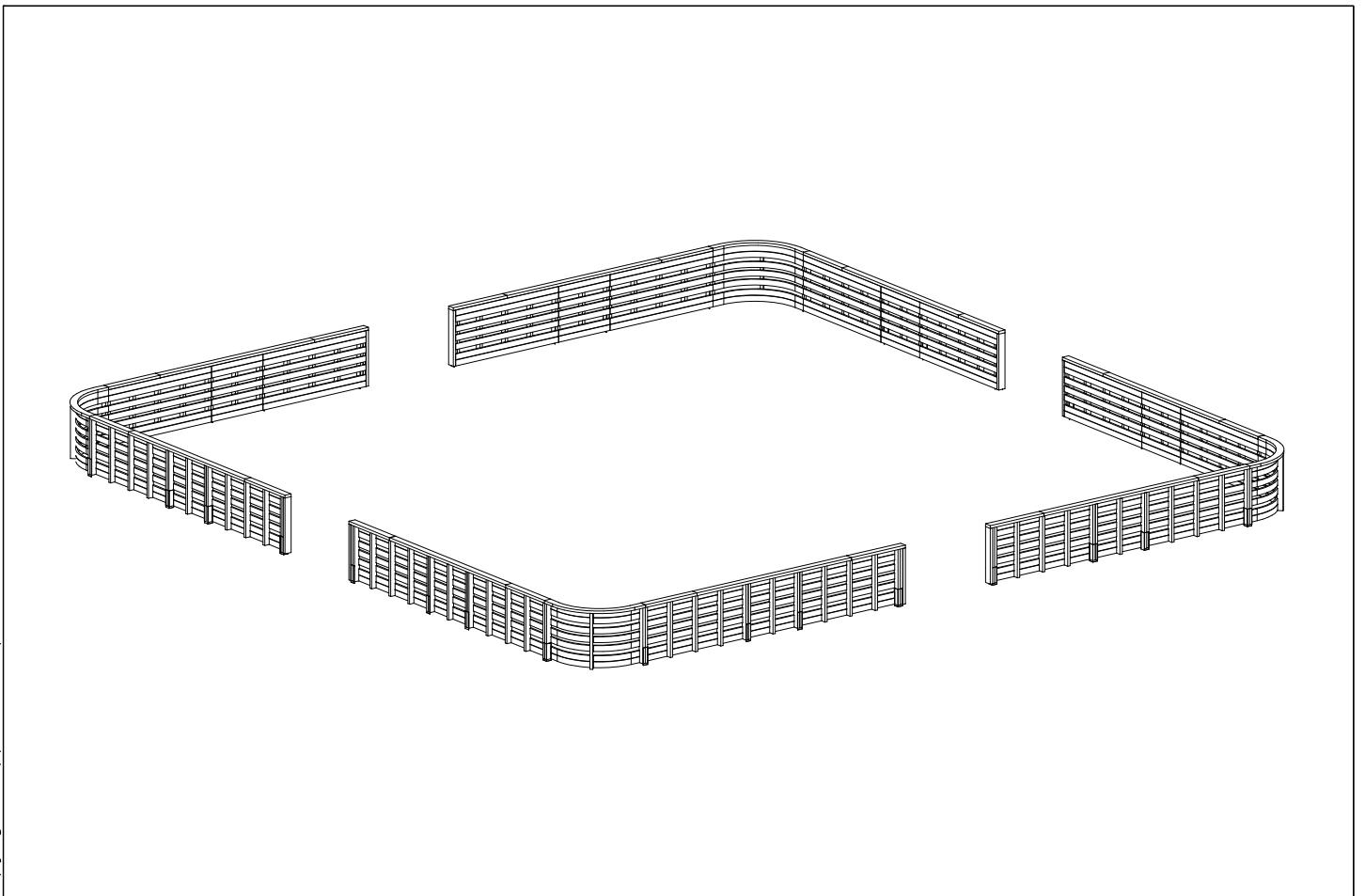
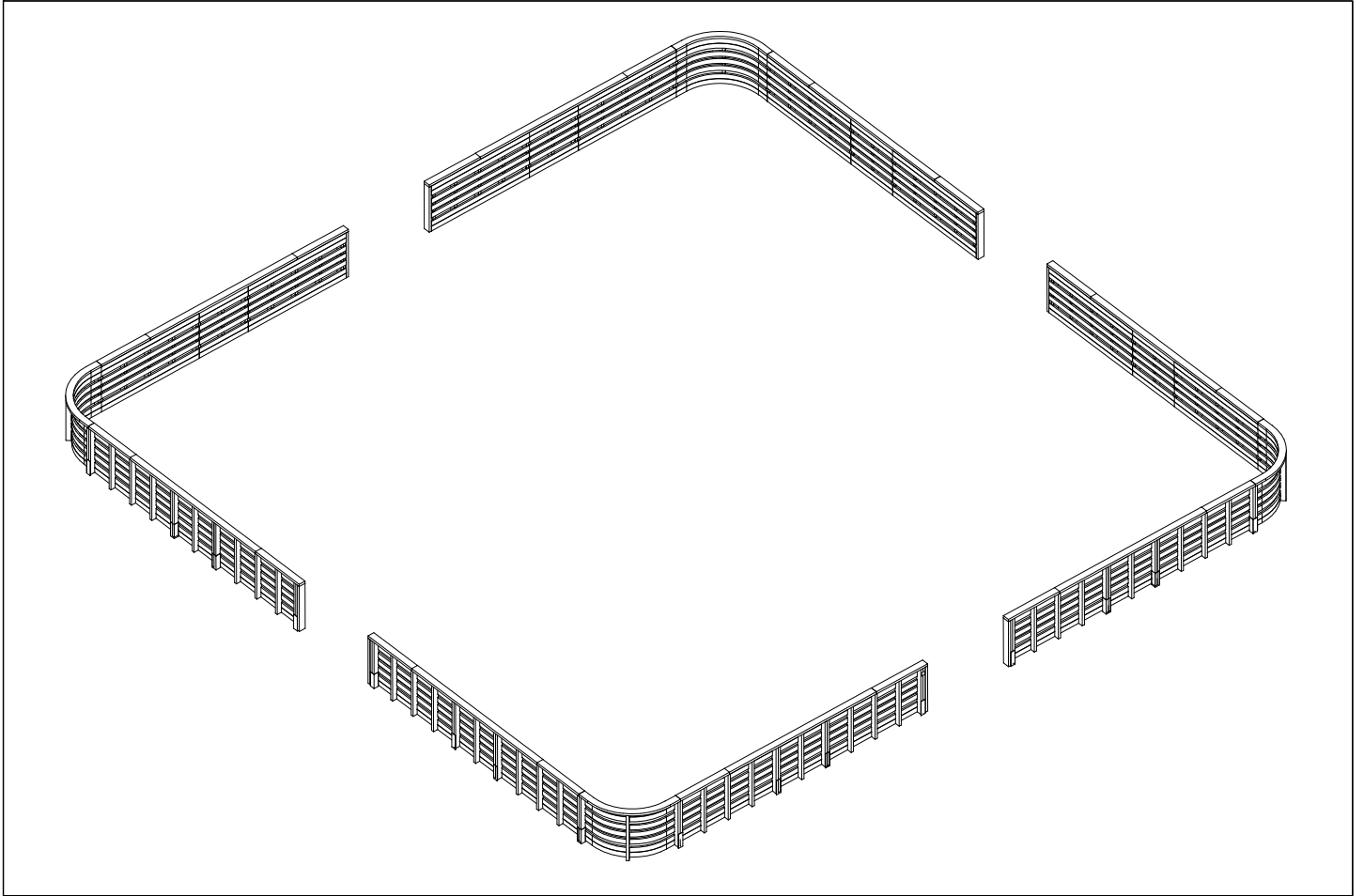

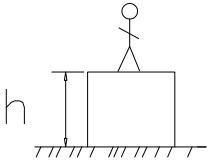

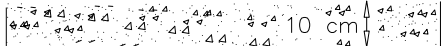
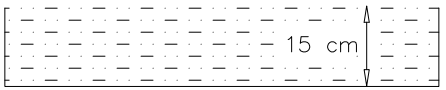
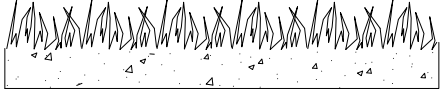
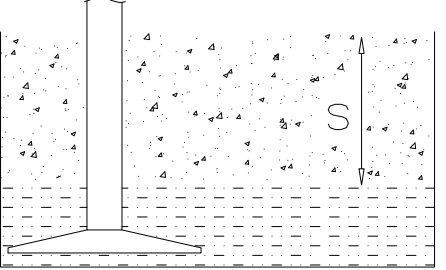
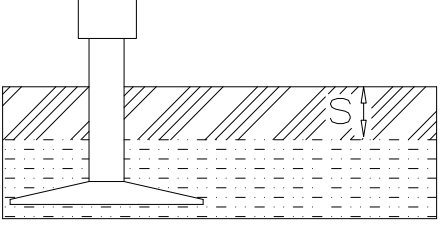
		
<p><b>h &lt; 1000</b></p>	<p>Totally hard surfaces or materials with very limited impact attenuating properties.</p> <p>Case by case risk assessment is needed including e.g. evaluation whether there is forced movement, what is the intended exercise and where will the product be installed.</p>	<p>Totally hard surfaces. E.g. concrete or asphalt</p>  <p>Materials with very limited impact attenuating properties. E.g. wood</p> 
<p><b>h &lt; 1200</b></p>	<p>Materials with significant impact attenuating properties.</p>	<p>fine gravel 0–8 mm</p>  <p>Unsorted sand/ topsoil</p> 
<p><b>h &lt; 1500</b></p>	<p>Lawn</p> 	
<p><b>h &lt; 3000</b></p>	<p>Loose fill material</p> <p>E.g. sand/gravel 0,25...8 mm D60/D10&lt;3,0 Woodchips 5...30 mm bark 20...80 mm</p>	 <p><u>S</u>                      <u>h</u> 30 cm                      &lt; 2,0 m 40 cm                      &lt; 3,0 m</p>
<p>Syntetic granulates</p> <p><u>S</u>                      <u>h</u> 40 mm                      ~ &gt; 1,2...1,3 m 50 mm                      ~ &gt; 1,5...1,7 m 60 mm                      ~ &gt; 1,8...2,0 m 70 mm                      ~ &gt; 2,1...2,5 m</p> <p>Note. For accurate values, see manufacturer's instructions.</p>		

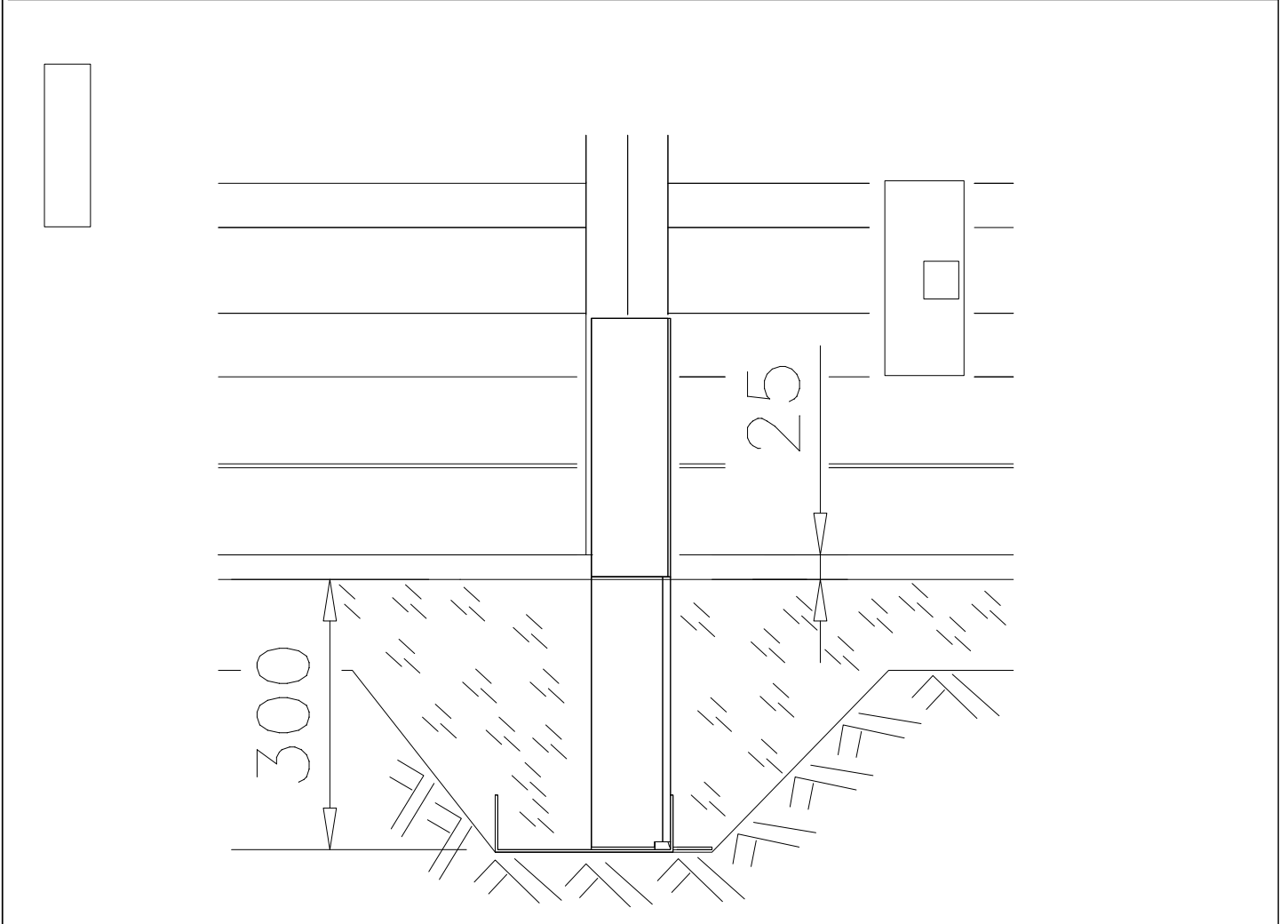
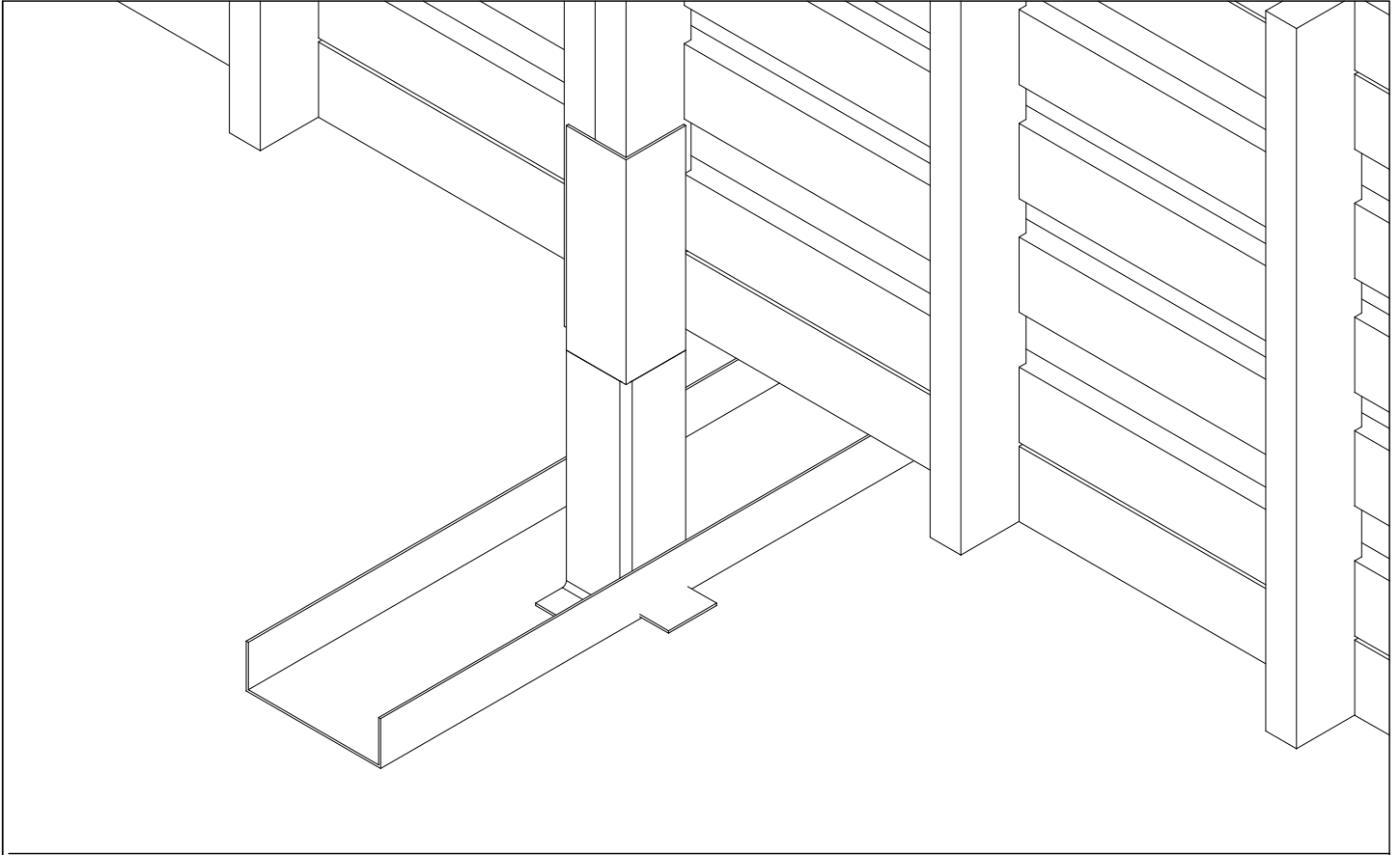

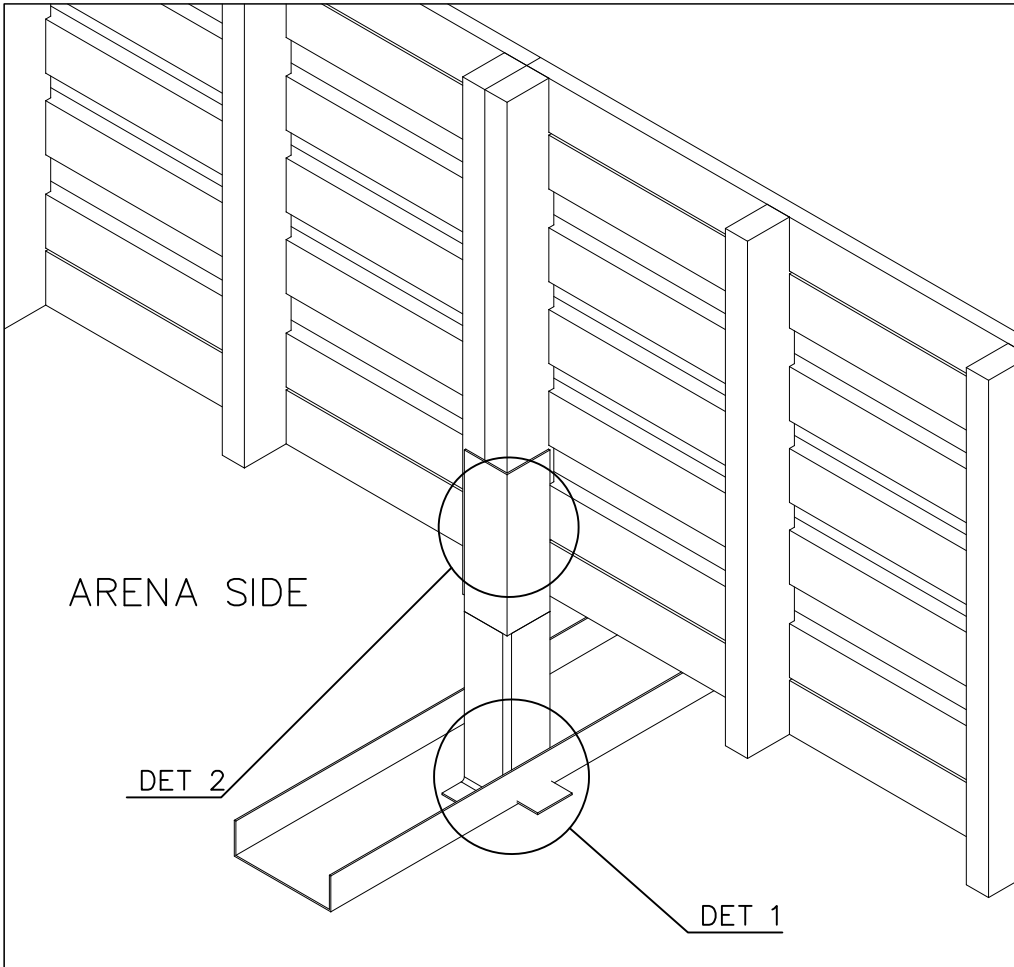

① 902433	PCS	② 902299	PCS
	1		1
③ 903149	PCS	④ 909248	PCS
	4		4
M12x30		M12	
⑤ 980154	PCS	⑥ 900240	PCS
	8		6
Ø24/13		Ø8x70	
	PCS		PCS

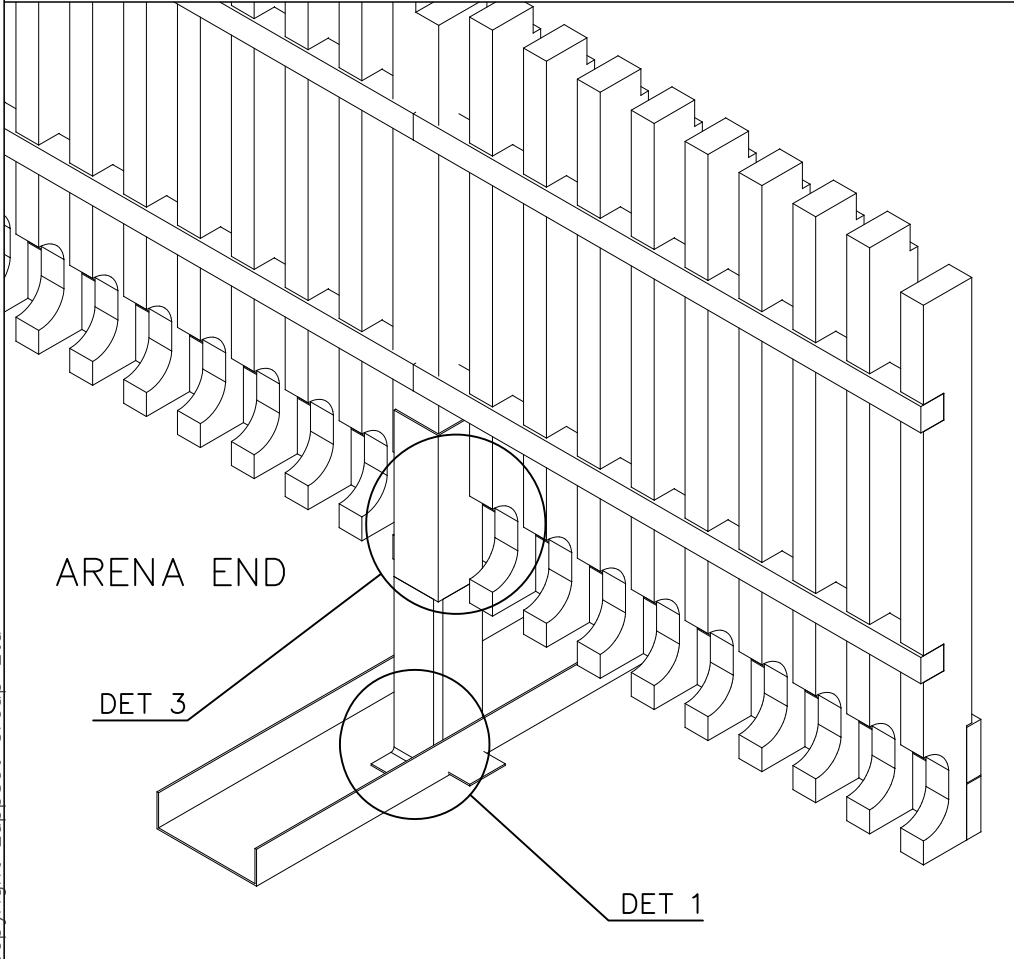

DET 1

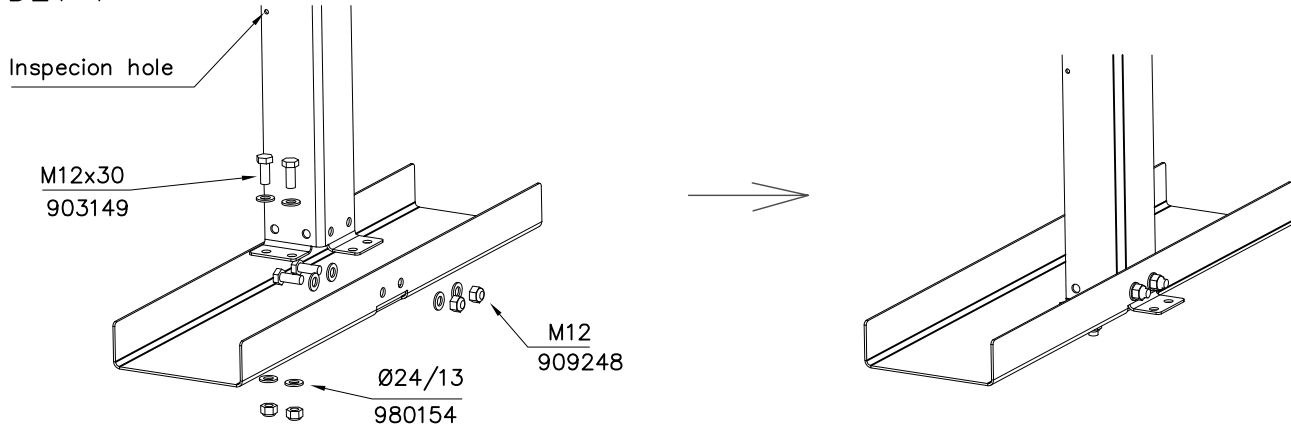

DET 2 ARENA SIDE

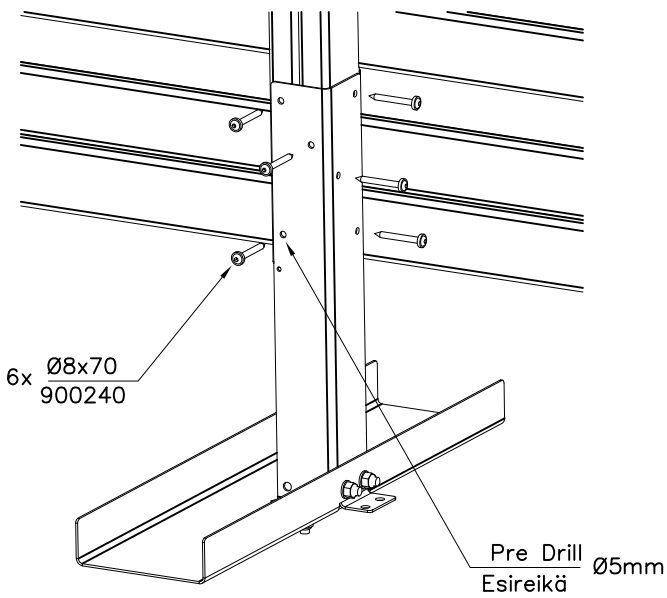

DET 3 ARENA END

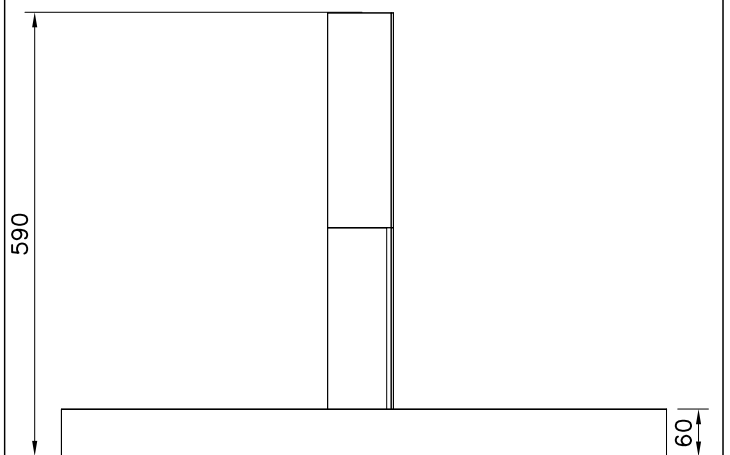
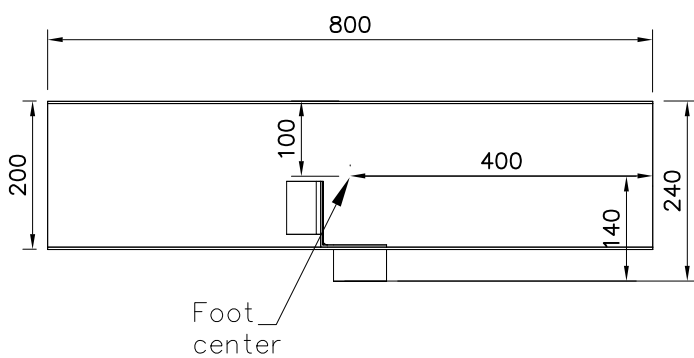
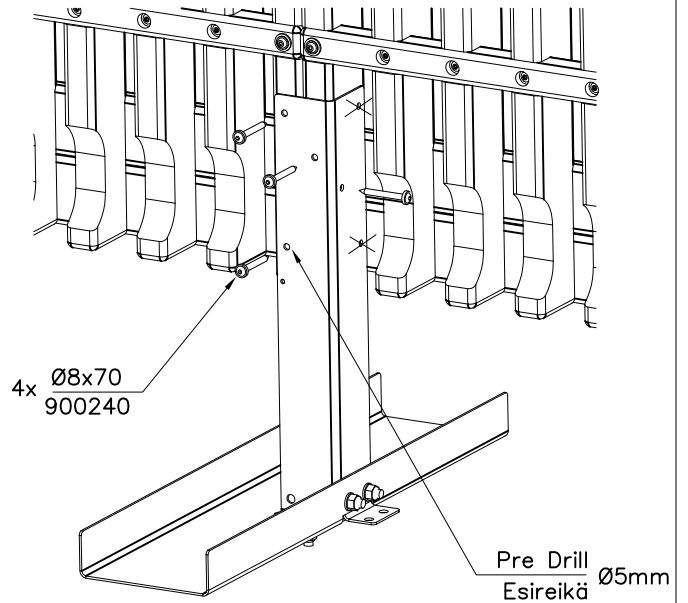

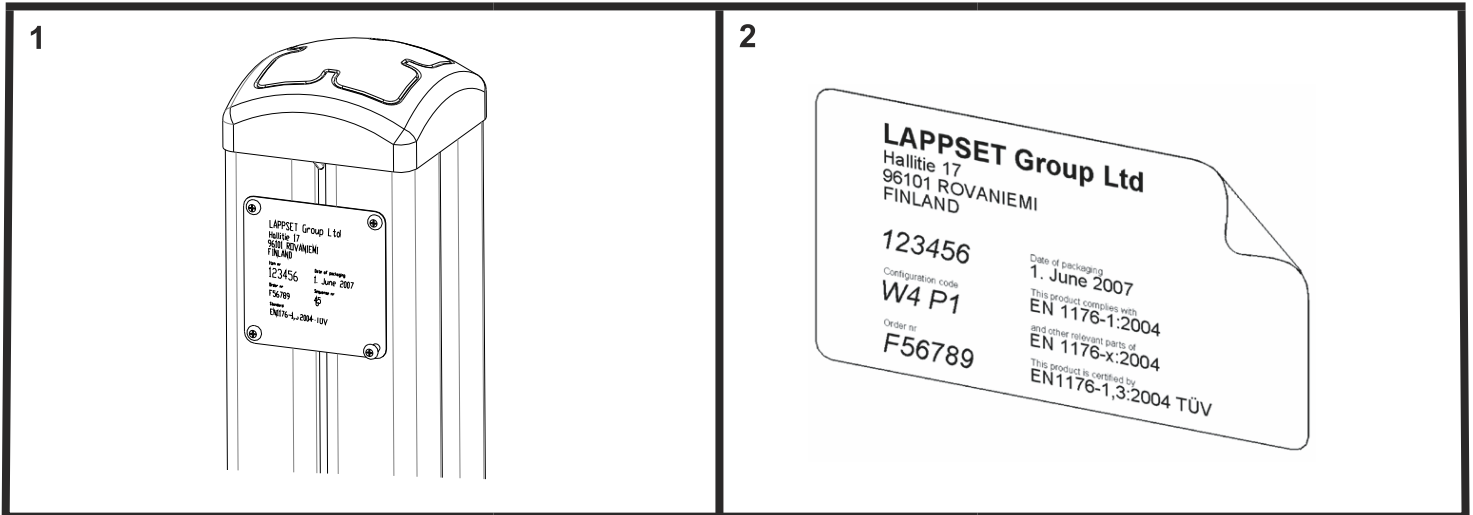

**Tuotekyltti tulee tuotteen mukana yhdellä seuraavista tavoista:**

**1) Metallinen tuotekyltti ja kiinnitysruuvit**

- Kiinnitä tuotekyltti ruuveilla tolppaan noin 2 metrin korkeuteen kuvan 1 mukaisesti.

**2) Tuotekylttitarra**

- Puhdista maalattu metalli- tai vaneripinta pölystä ja kosteudesta. Liimaa tarra kuvan 2 mukaisesti.
- Huom. Älä kiinnitä tarraa karheapintaiseen laminaattiin tai maalattuun puuhun.

**Vår produktmärkning levereras på ett av följande sätt:**

**1) Produktskylt i metall**

- Fäst skylten med de medföljande skruvarna

**2) Självhäftande produktetikett**

- Rengör den pulverlackerade metallytan eller laminatyten så att den blir fri från smuts och fukt. Fäst etiketten enligt fig. 2.
- Obs! Fäst ej etiketten på detaljer med skrovlig yta eller på målat trä.

**Product label is delivered by one of following ways:**

**1) Metal product label and screws**

- Fasten the label with screws.

**2) Label sticker**

- Clean the painted metal or plywood surface from dirt and moisture. Fasten the sticker as shown in the figure 2.
- Note. Do not attach the sticker to rough surfaced laminate or painted wood.

**La plaque d'informations produit est livrée sous l'une de ces 3 formes :**

**1) Plaque métallique et vis**

- Fixez la plaque à l'aide des vis.

**2) Etiquette autocollante**

- Avant de coller l'étiquette, nettoyez le composant métallique peint ou la plaque de contreplaqué, de toute saleté. La surface doit être sèche (voir image 2).
- Attention, ne pas coller l'étiquette sur une surface lamellé-collée irrégulière ou sur du bois peint.

**Die Auslieferung des Produktaufklebers erfolgt auf eine dieser Arten:**

**1) Produkt-Schild aus Metall incl. Schrauben**

- Die Befestigung des Schildes erfolgt mittels der Schrauben.

**2) Aufkleber**

- Entfernen Sie zunächst Schmutz und Feuchtigkeit vom lackierten Metall bzw. von der Holzoberfläche und bringen Sie den Aufkleber wie im Bild oben rechts beschrieben auf den gesäuberten Untergrund auf.
- Beachten Sie: Bringen Sie den Aufkleber nicht auf raues laminiertes oder lackiertes Holz an.