

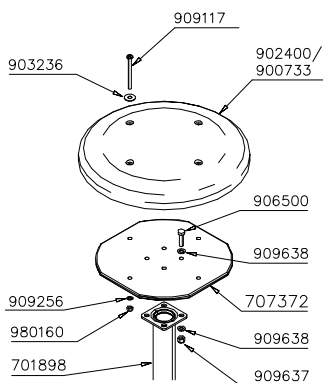

DET 1

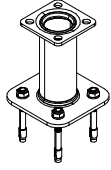
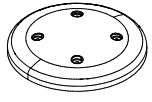
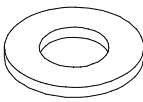
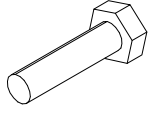
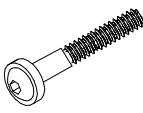
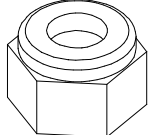
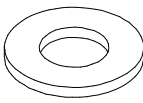
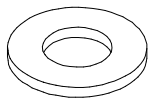

① 701898	PCS	② 900733	PCS
	1		1
STANDARD		Ø450x85	
③ 903236	PCS	④ 906500	PCS
	4		4
Ø30/10.5x2.5		M10x40	
⑤ 909117	PCS	⑥ 909637	PCS
	4		4
M8x100		M10	
⑦ 909638	PCS	⑧ 980151	PCS
	8		4
Ø20/10.5		Ø16/8.4	
⑨ 980160	PCS	⑩ 707372	PCS
	4		1
M8		340x340x20	
	PCS		PCS
	PCS		PCS
	PCS		PCS

LAPPSET®

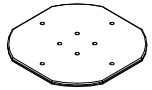
CLOXX







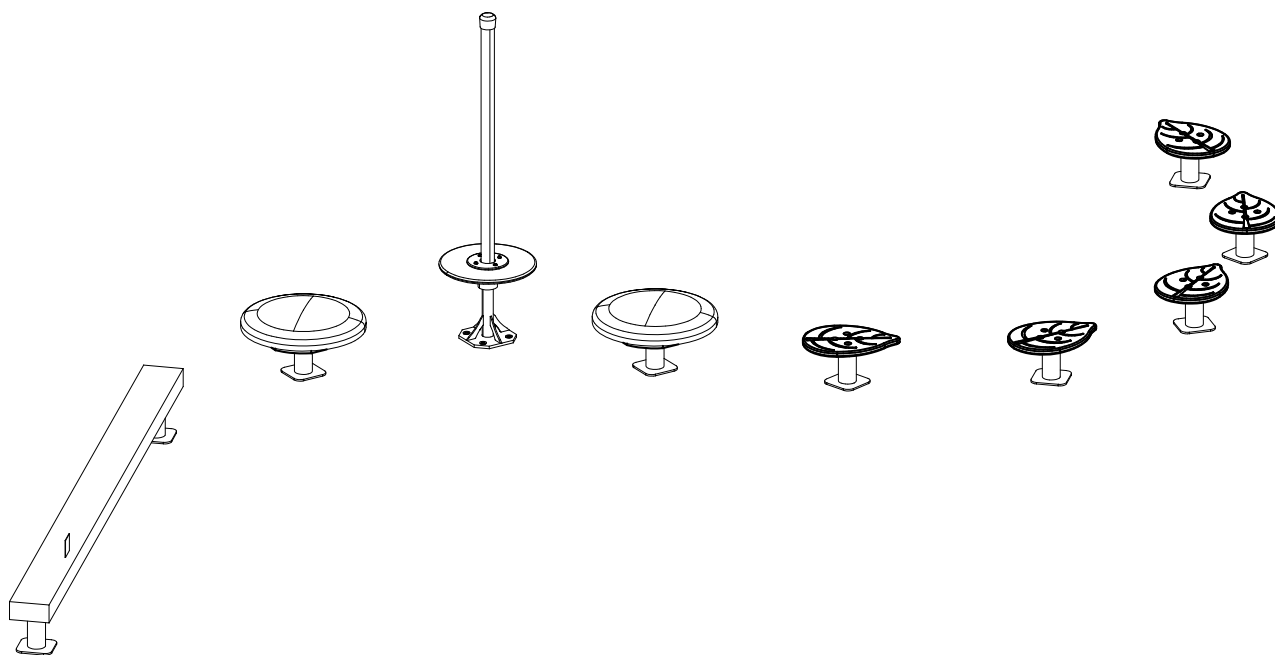

ASENNUSOHJE
MONTERINGSANSVISNING
INSTALLATION INSTRUCTION
AUFBAUANLEITUNG
NOTICE D'INSTALLATION

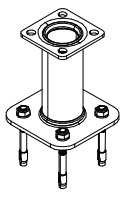
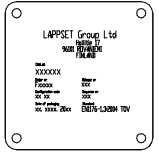
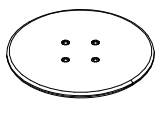
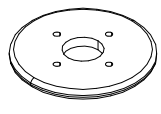
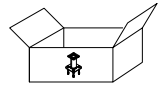
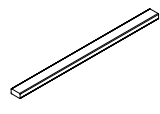
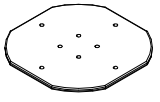
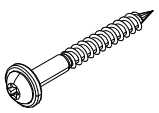
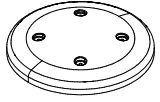
DATE: 10.10.2022

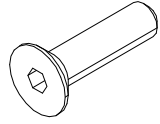
Q11361-1

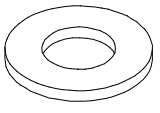
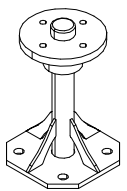

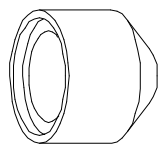
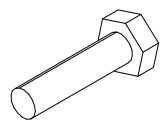
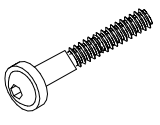
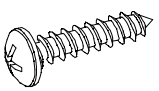
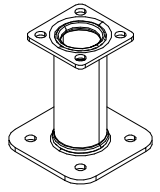
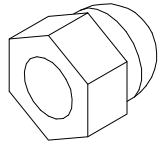
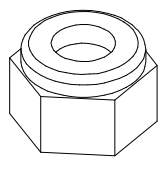
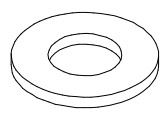
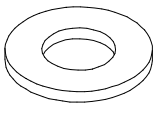
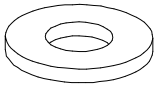
DATE: 10.10.2022

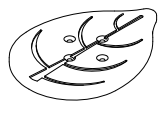
701898  STANDARD	PCS 7	702286  65x65	PCS 1	702844  Ø350x15	PCS 1	702845  Ø200x15	PCS 1	706551  L 2235	PCS 2	707263  L 2235	PCS 1
707372  340x340x20	PCS 2	900240  8x70	PCS 8	900733  Ø450x85	PCS 2	900735  M8x60	PCS 4	901487  M10x40	PCS 20	902625  Ø150x961	PCS 1
903236  Ø30/10.5x2.5	PCS 8	903379  Ø10x100	PCS 1	903403  Ø10x100	PCS 4	905051  Ø24/8.4	PCS 4	905104  M10	PCS 40	906500  M10x40	PCS 8
909117  M8x100	PCS 8	909506  Ø3.5x13	PCS 4	909531  M8	PCS 2	909633  M8	PCS 4	909637  M10	PCS 28	909638  Ø20/10.5	PCS 16
980151  Ø16/8.4	PCS 8	980154  Ø24/13	PCS 4	980160  M8	PCS 8	P03805  20x250x350	PCS 5		PCS		PCS
	PCS		PCS		PCS		PCS		PCS		PCS
	PCS		PCS		PCS		PCS		PCS		PCS

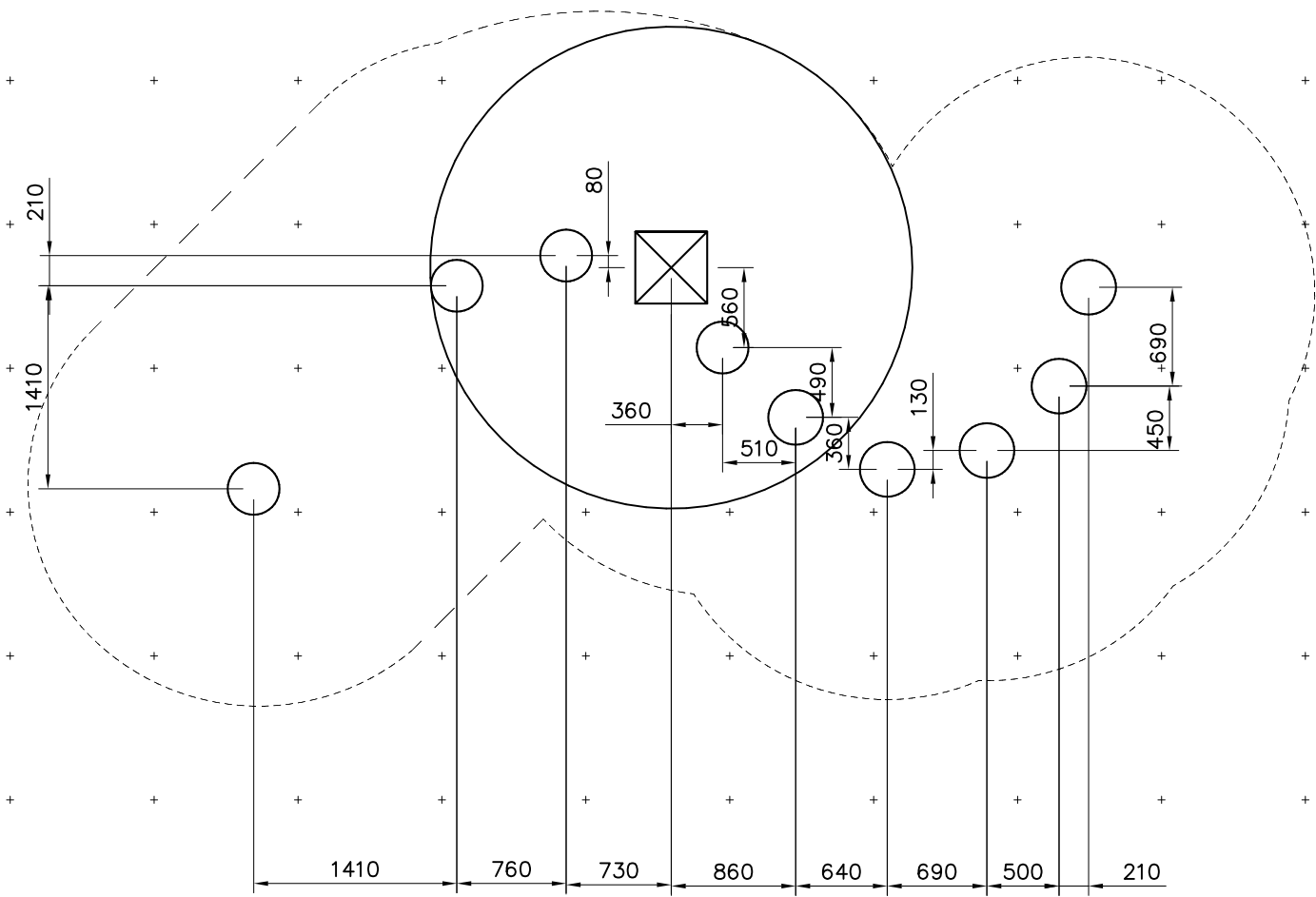
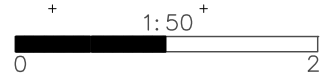

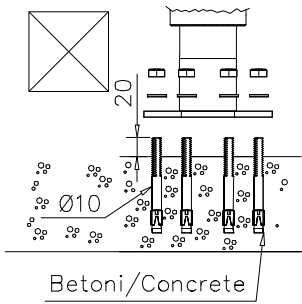
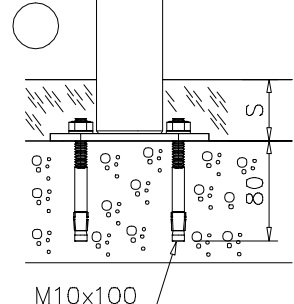
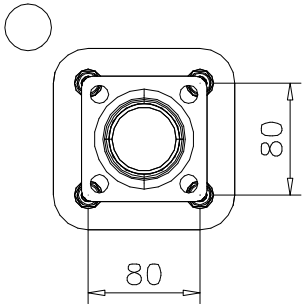
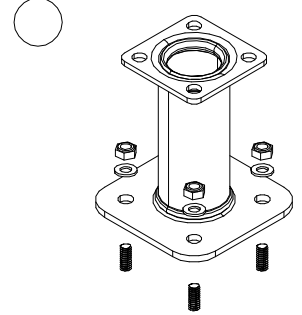
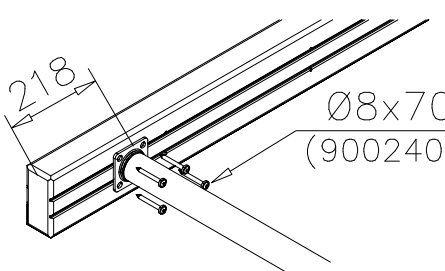
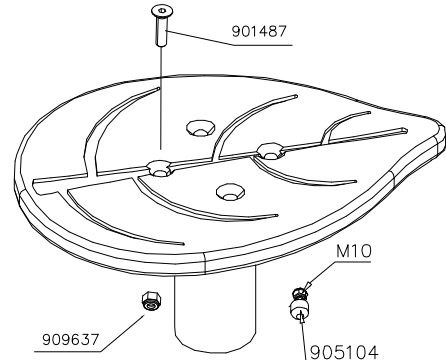
 <p>Betoni/Concrete</p>	 <p>M10x100</p>	
	<p>DET 1</p>  <p>Ø8x70 (900240)</p>	<p>DET 2</p>  <p>901487 909637 M10 905104</p>



Thickness of the concrete 150 mm

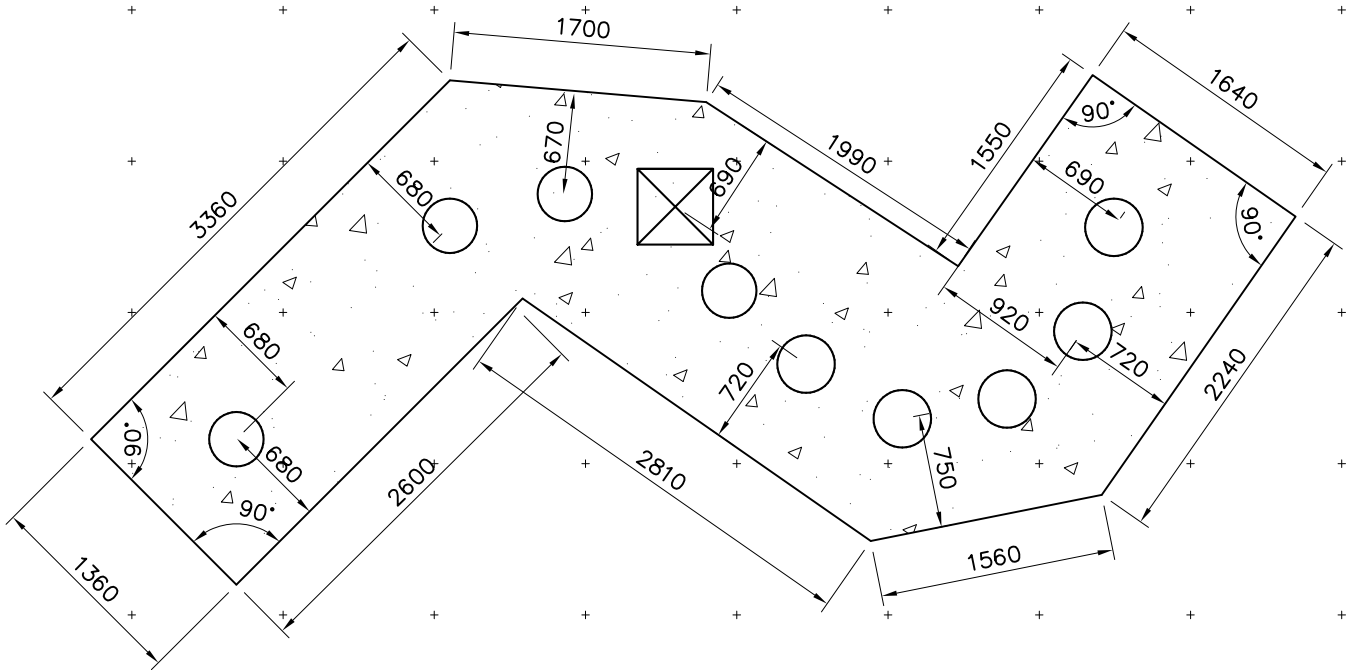



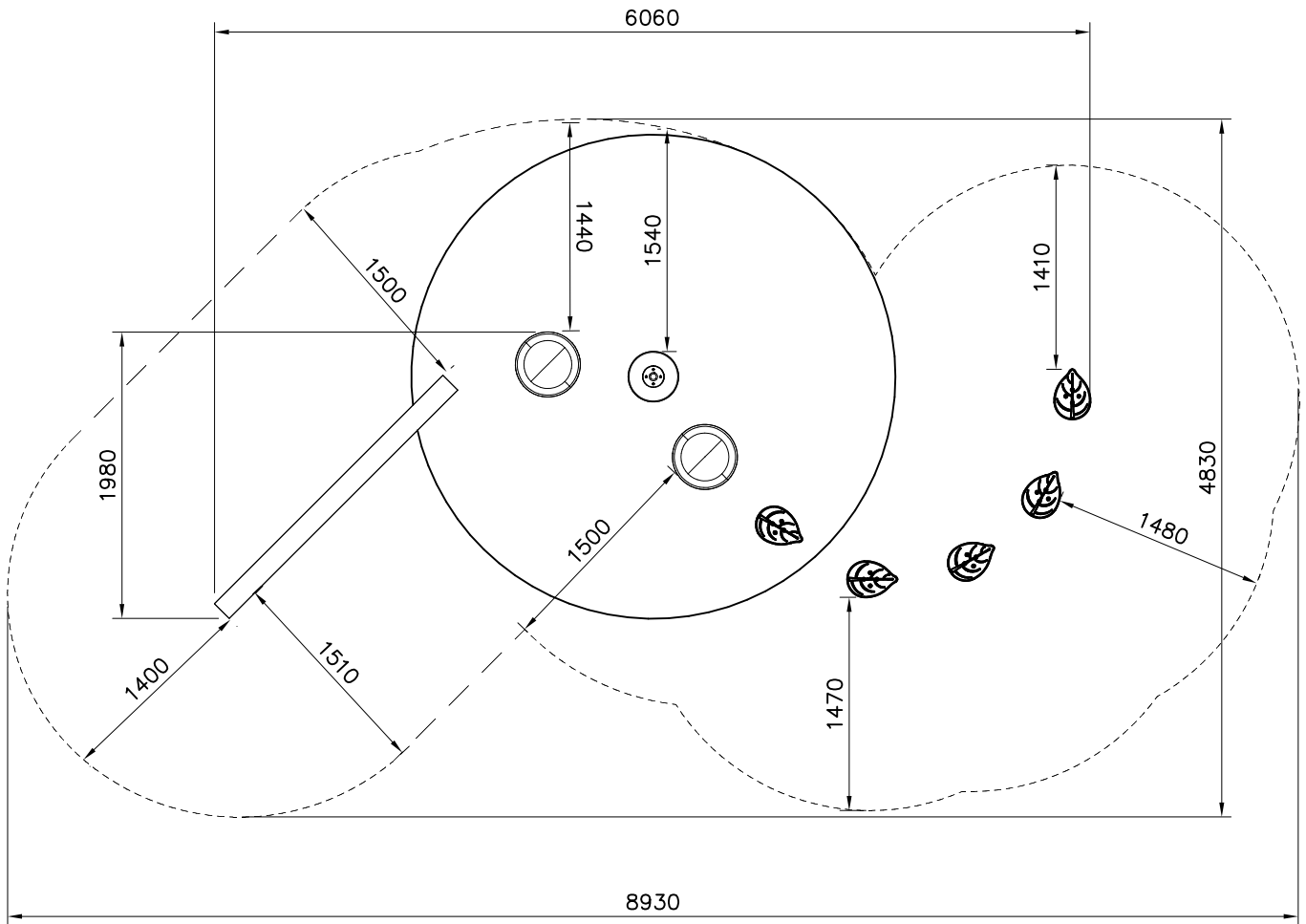

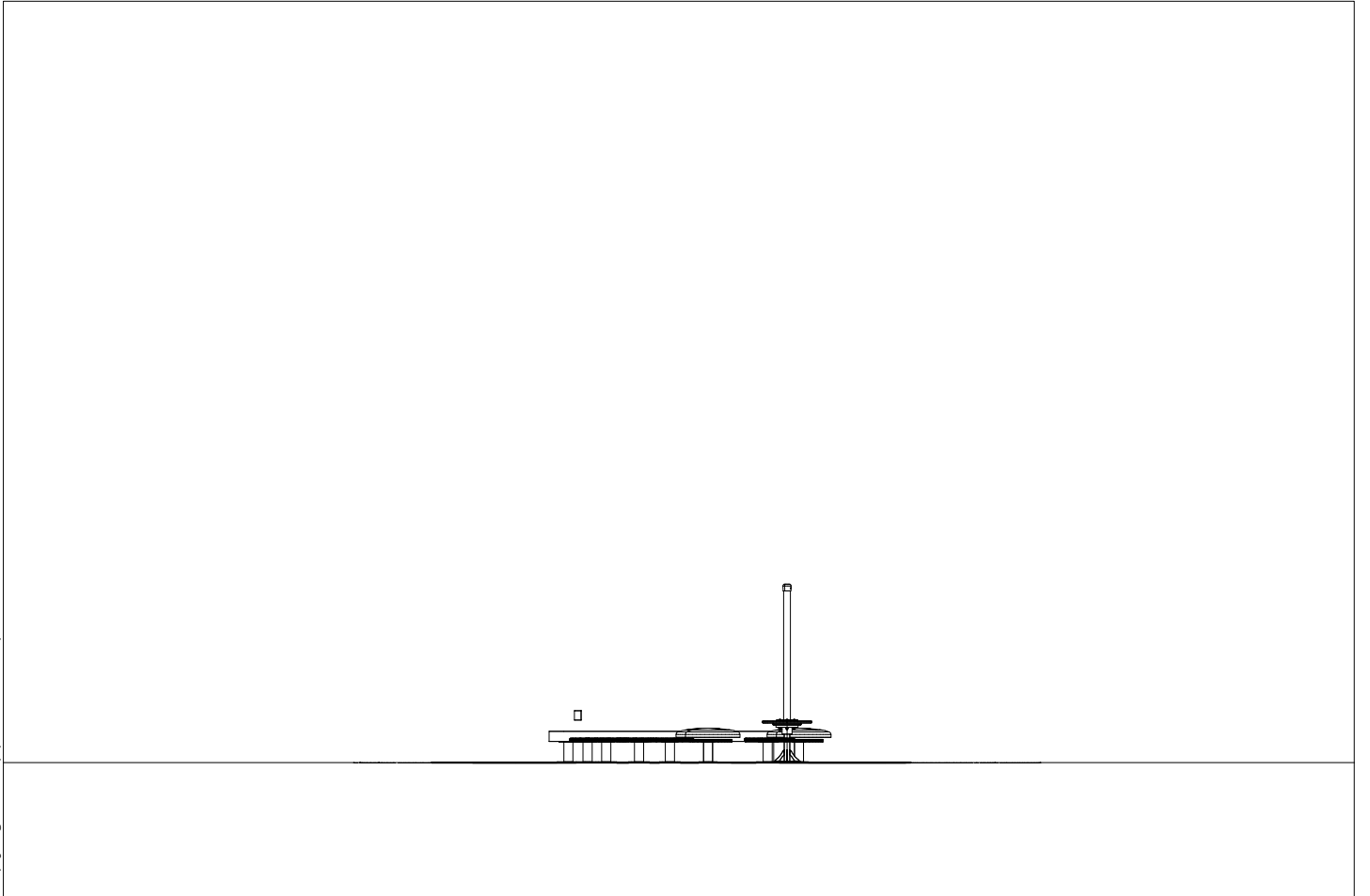
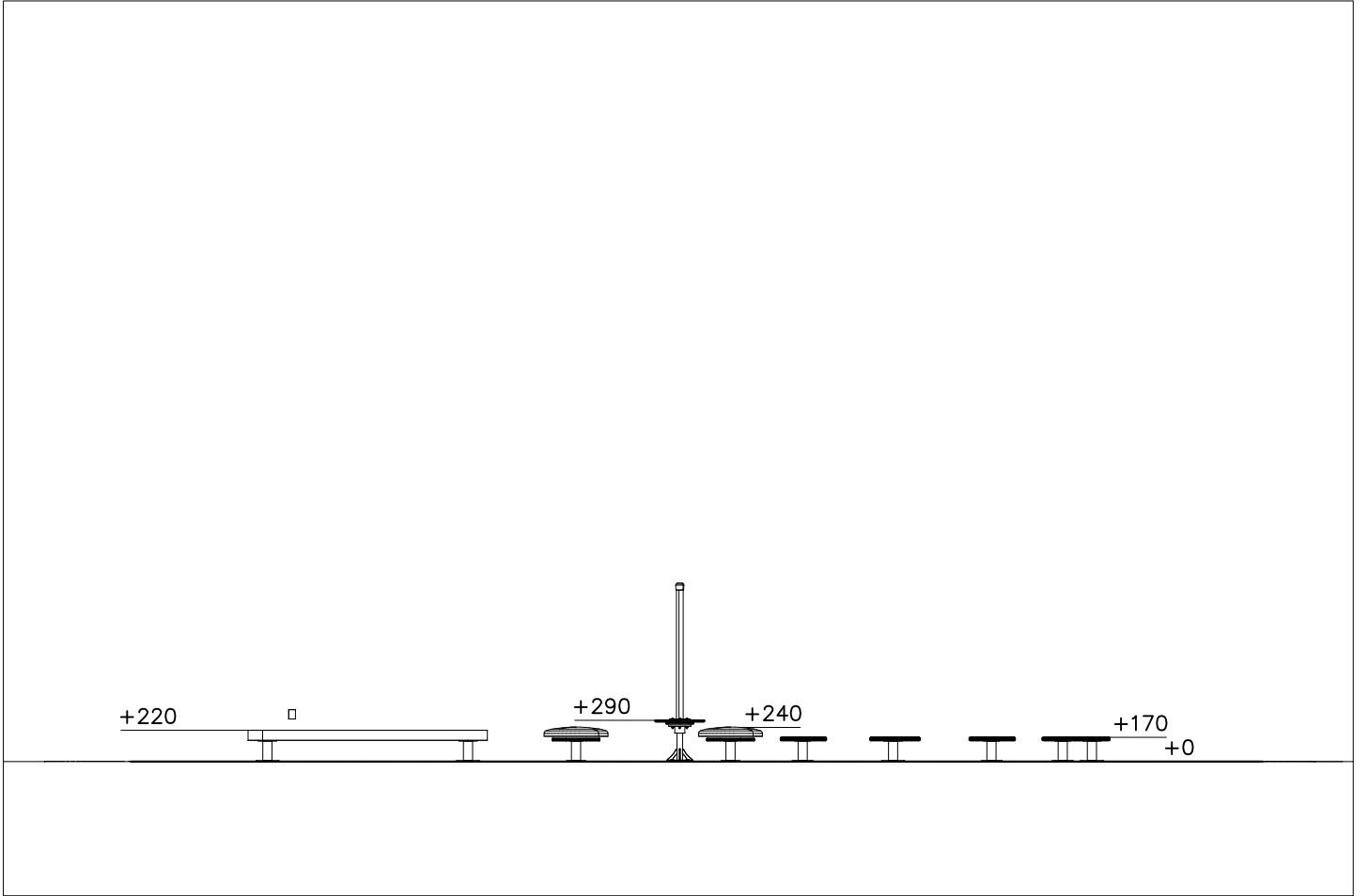
- EN/AS Impact Area 8.8 m²
- - - Falling Space 32.2 m²
Max Falling Height 600 mm

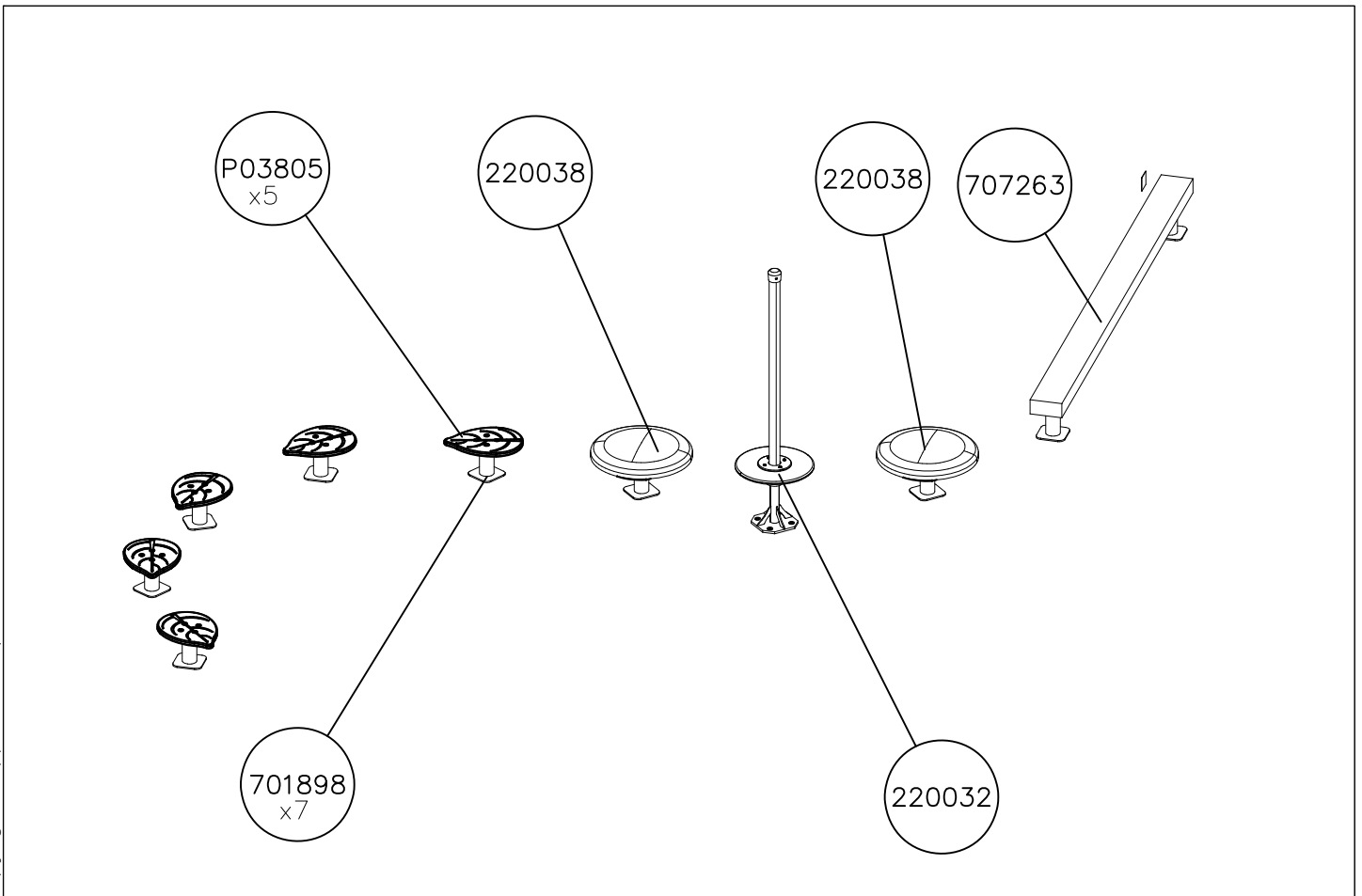
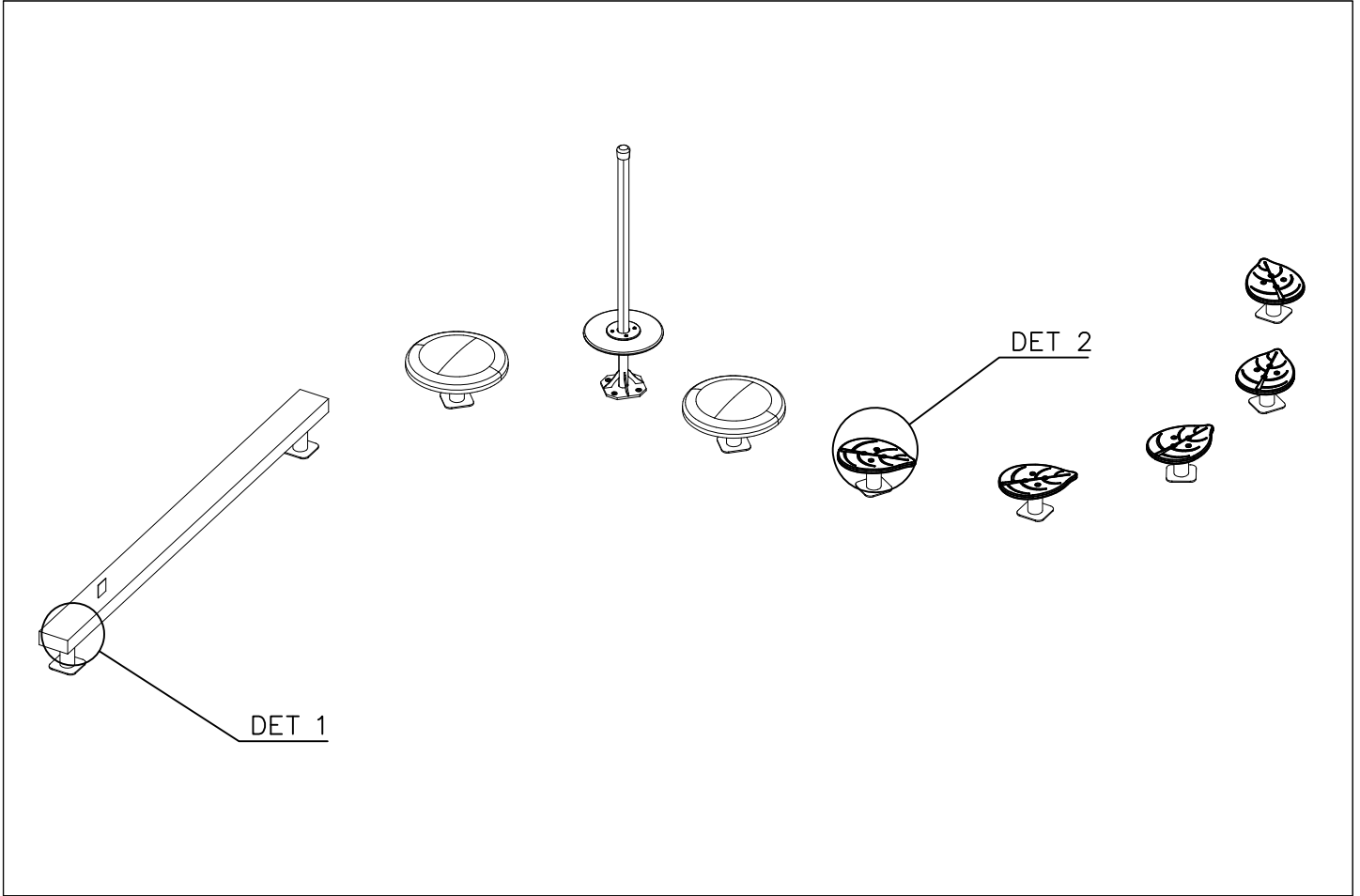

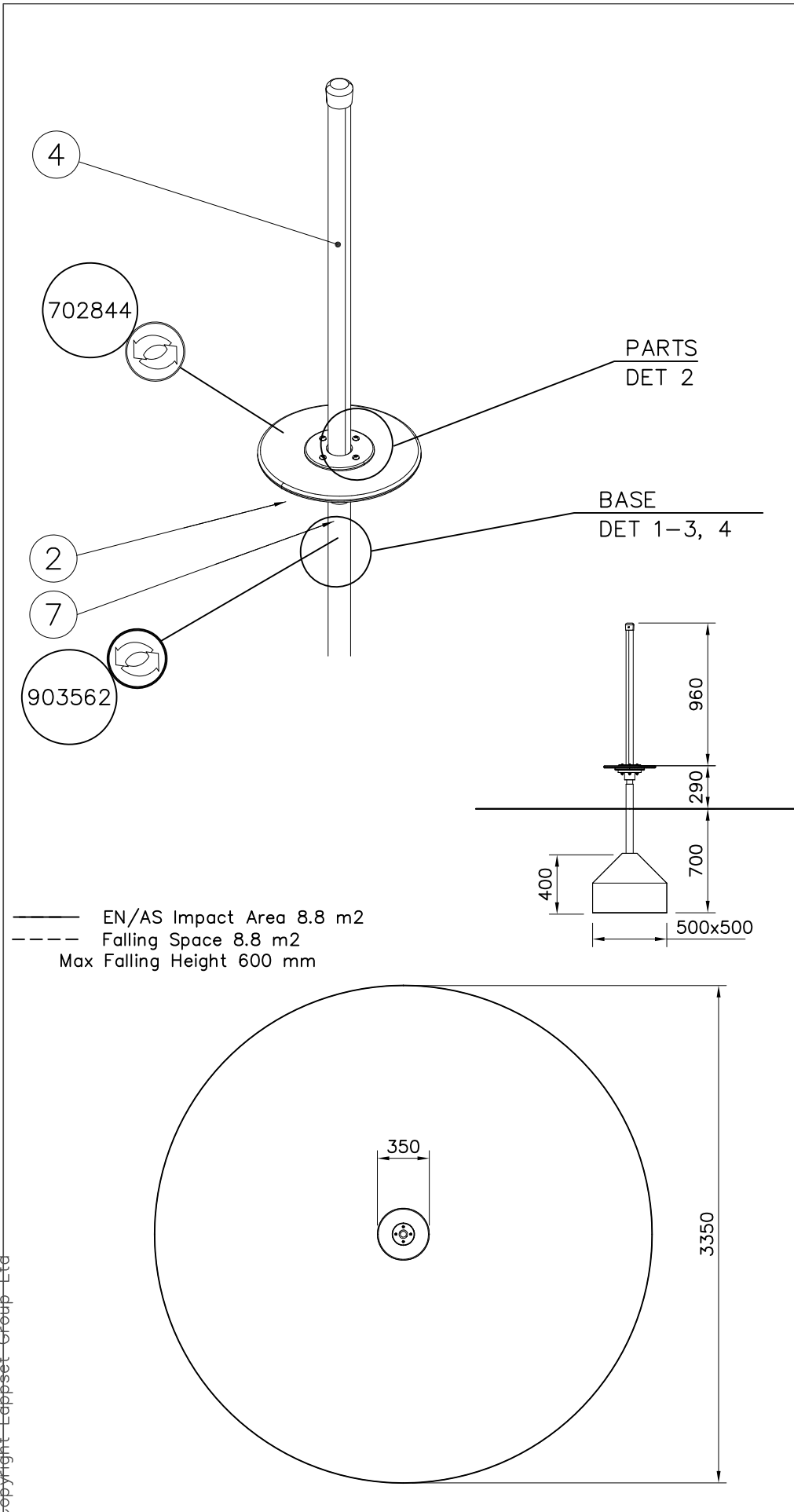

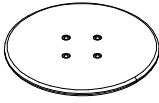
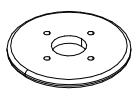

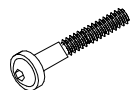
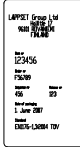

① 702844	PCS	② 702845	PCS
	1		1
Ø350x15		Ø200x15	
③ 903562	PCS	④ 902625	PCS
	1		1
		Ø150x954	
⑤ 909633	PCS	⑥ 909866	PCS
	4		4
M8		M8x60	
⑦ 702341	PCS		PCS
	1		
90x50			
	PCS		PCS
	PCS		PCS
	PCS		PCS
	PCS		PCS

		
<p>$h < 600$</p> <p>Without movement and therefore without Impact Area</p>	<p>Totally hard surfaces.</p> <p>Note. Lappset does <u>not recommend</u> totally hard surfaces at all.</p>	<p>E.g. concrete or asphalt</p> 
<p>$h < 600$</p> <p>With movement e.g. rocking</p>	<p>Materials with very limited impact attenuating properties.</p>	<p>E.g. wood</p> 
<p>$h < 1000$</p>	<p>Materials with significant impact attenuating properties.</p>	<p>fine gravel 0–8 mm</p>  <p>grass</p>  <p>unsorted sand</p> 
<p>$h < 3000$</p>	<p>Loose fill material</p> <p>E.g. sand/gravel 0,25...8 mm D60/D10<3,0 Woodchips 5...30 mm bark 20...80 mm</p>	 <p>\underline{S} \underline{h}</p> <p>30 cm < 2,0 m</p> <p>40 cm < 3,0 m</p>
	<p>Syntethic granulates</p> <p>\underline{S} \underline{h}</p> <p>40 mm ~> 1,2...1,3 m</p> <p>50 mm ~> 1,5...1,7 m</p> <p>60 mm ~> 1,8...2,0 m</p> <p>70 mm ~> 2,1...2,5 m</p> <p>Note. For accurate values, see manufacturer's instructions.</p>	

REMOVE SAFETY SURFACE/SAND/GRAVEL
TO CHECK FOUNDATION

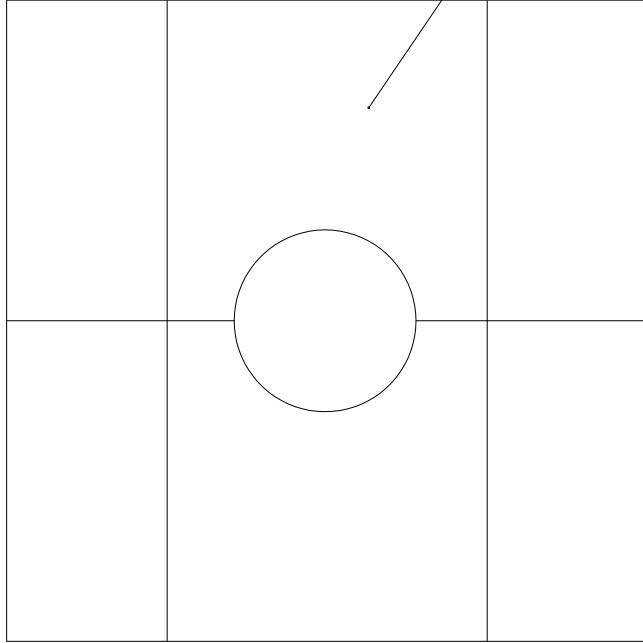

REMOVE SAFETY SURFACE/SAND/GRAVEL
TO CHECK FOUNDATION



**Tuotekyltti tulee tuotteen mukana yhdellä seuraavista tavoista:****1) Metallinen tuotekyltti ja kiinnitysruuvit**

- Kiinnitä tuotekyltti ruuveilla tolppaan noin 2 metrin korkeuteen kuvan 1 mukaisesti.

2) Tuotekyltitarra

- Puhdista maalattu metalli- tai vaneripinta pölystä ja kosteudesta. Liimaa tarra kuvan 2 mukaisesti.
- Huom. Älä kiinnitä tarraa karheapintaiseen laminaattiin tai maalattuun puuhun.

Vår produktmärkning levereras på ett av följande sätt:**1) Produktskylt i metall**

- Fäst skylten med de medföljande skruvarna

2) Självhäftande produktetikett

- Rengör den pulverlackerade metallytan eller laminatyten så att den blir fri från smuts och fukt. Fäst etiketten enligt fig. 2.
- Obs! Fäst ej etiketten på detaljer med skrovlig yta eller på målat trä.

Product label is delivered by one of following ways:**1) Metal product label and screws**

- Fasten the label with screws.

2) Label sticker

- Clean the painted metal or plywood surface from dirt and moisture. Fasten the sticker as shown in the figure 2.
- Note. Do not attach the sticker to rough surfaced laminate or painted wood.

La plaque d'informations produit est livrée sous l'une de ces 3 formes :**1) Plaque métallique et vis**

- Fixez la plaque à l'aide des vis.

2) Etiquette autocollante

- Avant de coller l'étiquette, nettoyez le composant métallique peint ou la plaque de contreplaqué, de toute saleté. La surface doit être sèche (voir image 2).
- Attention, ne pas coller l'étiquette sur une surface lamellé-collée irrégulière ou sur du bois peint.

Die Auslieferung des Produktaufklebers erfolgt auf eine dieser Arten:**1) Produkt-Schild aus Metall incl. Schrauben**

- Die Befestigung des Schildes erfolgt mittels der Schrauben.

2) Aufkleber

- Entfernen Sie zunächst Schmutz und Feuchtigkeit vom lackierten Metall bzw. von der Holzoberfläche und bringen Sie den Aufkleber wie im Bild oben rechts beschrieben auf den gesäuberten Untergrund auf.
- Beachten Sie: Bringen Sie den Aufkleber nicht auf raues laminiertes oder lackiertes Holz an.



DET 1, 2, 3

① 909531	PCS	① 909513	PCS
	1		1
		60°	
① 909514	PCS	① 902056	PCS
	1		1
		75°	57°
① 902062	PCS		PCS
	1		
		70°	
	PCS		PCS
	PCS		PCS
② 909628	PCS		PCS
	4		
M10x100			

DET 1



DET 2

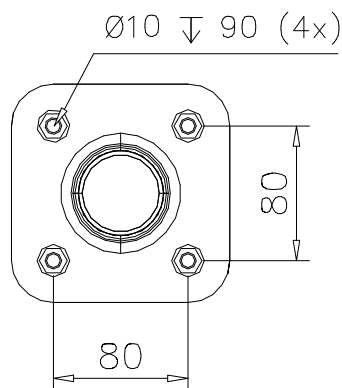

DET 3

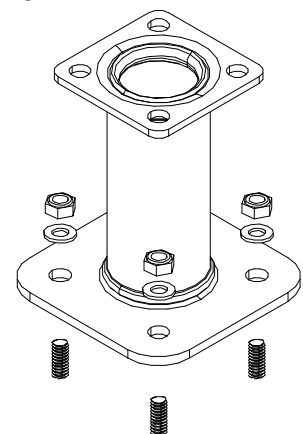

LAPPSET®
BETON FOUNDATION

FOOT

DATE: 27.10.2015

1(1)

② 905104	PCS		PCS
	4		
 M10	PCS		PCS

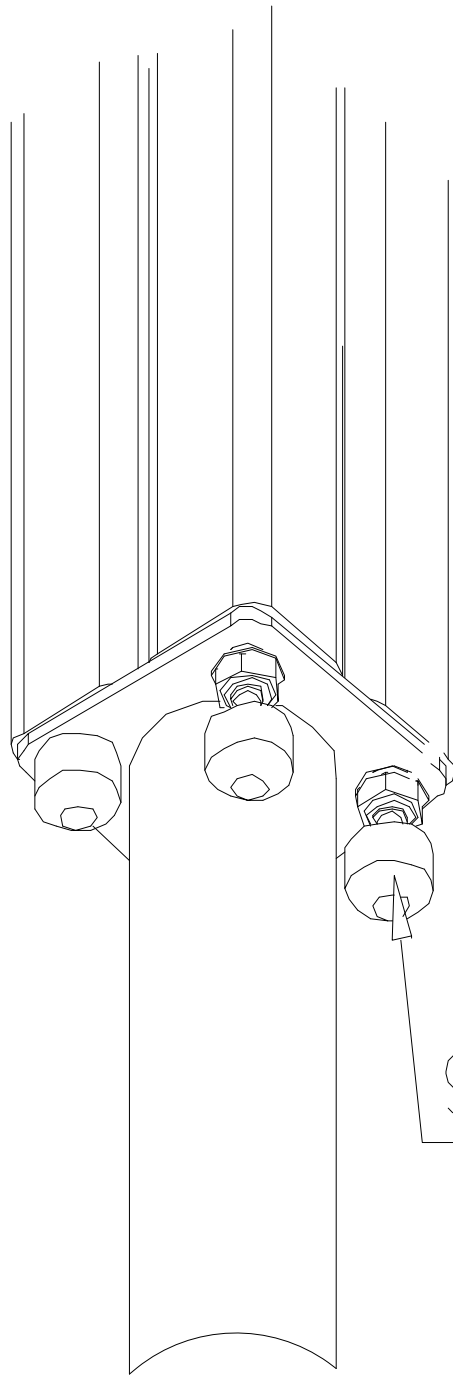

905104