

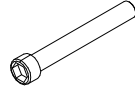

DO NOT TIGHTEN THE JOINTS UNTIL THE STRUCTURE IS COMPLETE.

① 901803	PCS	② 901994	PCS
	2		2
M12x90		Ø190	
③ 902096	PCS	④ 902234	PCS
	4		6
M12x120		M12	
	PCS		PCS
	PCS		PCS
	PCS		PCS
	PCS		PCS
	PCS		PCS
	PCS		PCS

DET 1

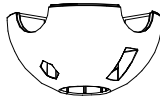
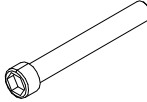

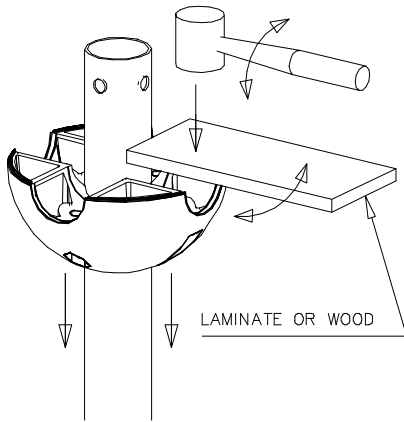
DET 2

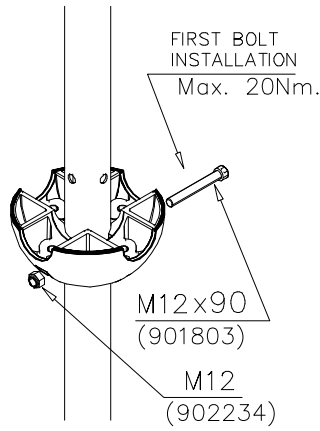

DET 3

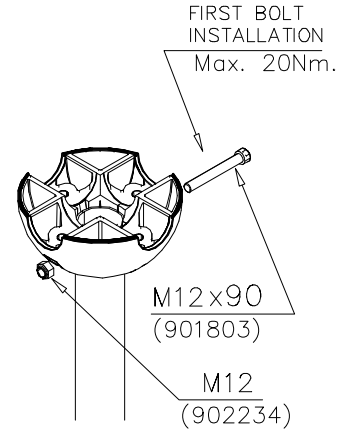

DET 4

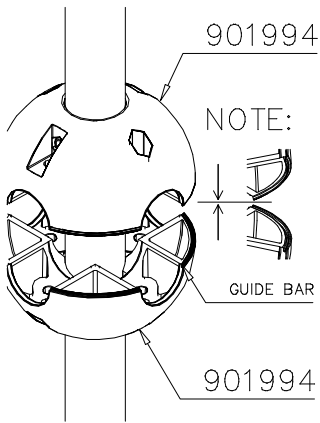

DET 5

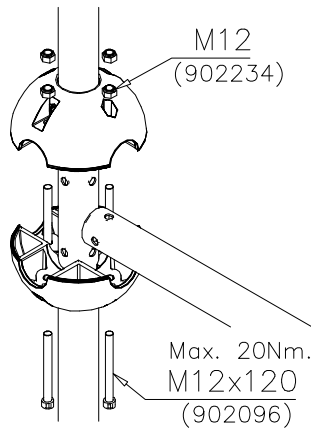

DET 6

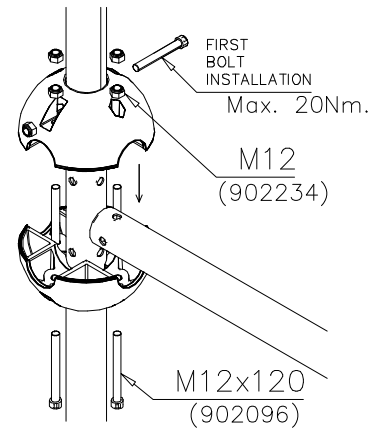

REMEMBER  
FINAL  
TIGHTENING



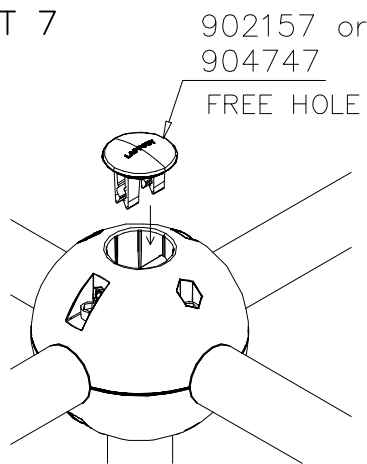

DET 7

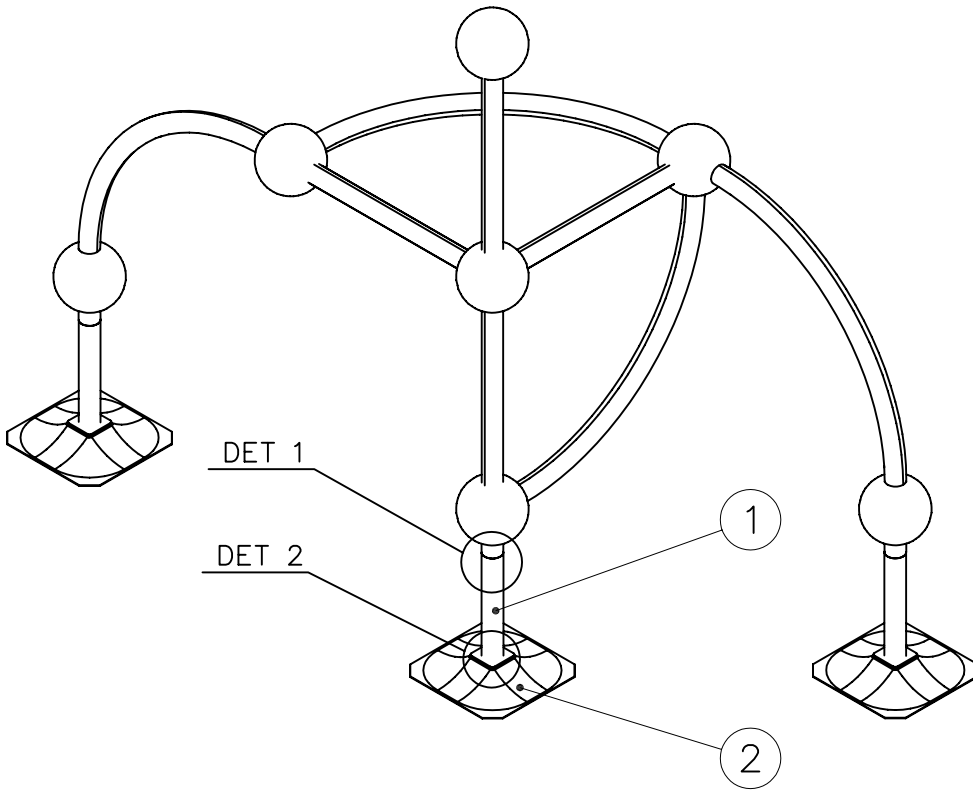

DET 8

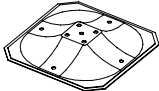



① 902094	PCS	② 909519	PCS
	1		1
Ø60x450		50x380x380	
③ 909637	PCS	④ 909638	PCS
	4		4
M10		Ø20/10,5	
⑤ 909639	PCS		PCS
	4		
M10x25			
	PCS		PCS
	PCS		PCS
	PCS		PCS

DET 1

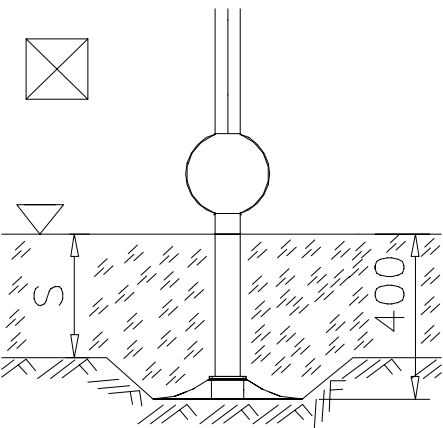

DET 2

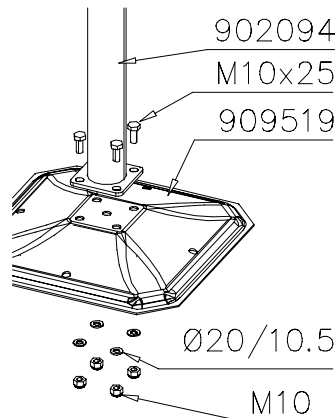









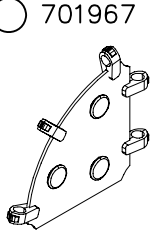
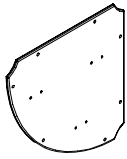
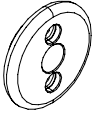
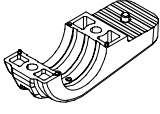

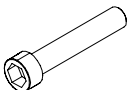
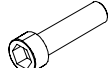
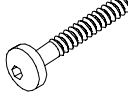
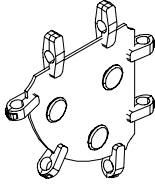
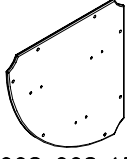
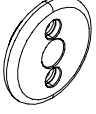
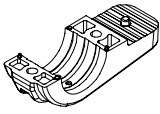
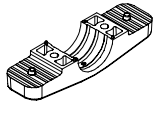

# LAPPSET® WALL AND FLOOR

# CLOXX

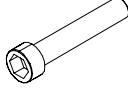
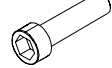
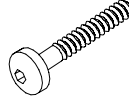
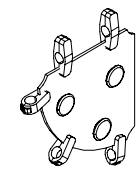
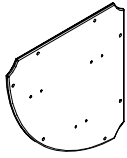
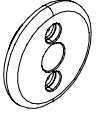
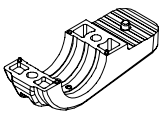
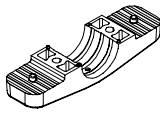
DATE: 3.8.2010

1(3)

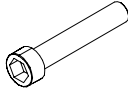
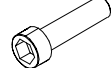
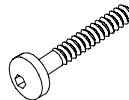
 <p>701967</p>	 <p>701936</p> <p>668x668x15</p>	<p>PCS</p> <p>1</p>	 <p>929322</p> <p>Ø120x30</p>	<p>PCS</p> <p>3</p>	 <p>902124</p> <p>150x50x50</p>	<p>PCS</p> <p>10</p>	 <p>980161</p> <p>M10</p>	<p>PCS</p> <p>10</p>	 <p>905112</p> <p>Ø22</p>	<p>PCS</p> <p>6</p>	 <p>980150</p> <p>M8</p>	<p>PCS</p> <p>6</p>
	 <p>909256</p> <p>Ø16/8.4x1.6</p>	<p>PCS</p> <p>6</p>	 <p>902232</p> <p>M10x55</p>	<p>PCS</p> <p>5</p>	 <p>902233</p> <p>M10x30</p>	<p>PCS</p> <p>5</p>	 <p>901899</p> <p>M8x45</p>	<p>PCS</p> <p>6</p>		<p>PCS</p>		<p>PCS</p>
		<p>PCS</p>		<p>PCS</p>		<p>PCS</p>		<p>PCS</p>		<p>PCS</p>		<p>PCS</p>
 <p>701987</p>	 <p>701936</p> <p>668x668x15</p>	<p>PCS</p> <p>1</p>	 <p>929322</p> <p>Ø120x30</p>	<p>PCS</p> <p>3</p>	 <p>902124</p> <p>150x50x50</p>	<p>PCS</p> <p>10</p>	 <p>902197</p> <p>200x50x50</p>	<p>PCS</p> <p>4</p>	 <p>980161</p> <p>M10</p>	<p>PCS</p> <p>14</p>	 <p>905112</p> <p>Ø22</p>	<p>PCS</p> <p>6</p>
	 <p>980160</p> <p>M8</p>	<p>PCS</p> <p>6</p>	 <p>909256</p> <p>Ø16/8.4x1.6</p>	<p>PCS</p> <p>6</p>	 <p>902232</p> <p>M10x55</p>	<p>PCS</p> <p>9</p>	 <p>902233</p> <p>M10x30</p>	<p>PCS</p> <p>5</p>	 <p>901899</p> <p>M8x45</p>	<p>PCS</p> <p>6</p>		<p>PCS</p>
		<p>PCS</p>		<p>PCS</p>		<p>PCS</p>		<p>PCS</p>		<p>PCS</p>		<p>PCS</p>
 <p>702046</p>	 <p>701936</p> <p>668x668x15</p>	<p>PCS</p> <p>1</p>	 <p>929322</p> <p>Ø120x30</p>	<p>PCS</p> <p>3</p>	 <p>902124</p> <p>150x50x50</p>	<p>PCS</p> <p>10</p>	 <p>902197</p> <p>200x50x50</p>	<p>PCS</p> <p>4</p>	 <p>980161</p> <p>M10</p>	<p>PCS</p> <p>10</p>	 <p>905112</p> <p>Ø22</p>	<p>PCS</p> <p>6</p>
	 <p>980150</p> <p>M8</p>	<p>PCS</p> <p>6</p>	 <p>909256</p> <p>Ø16/8.4x1.6</p>	<p>PCS</p> <p>6</p>	 <p>902232</p> <p>M10x55</p>	<p>PCS</p> <p>7</p>	 <p>902233</p> <p>M10x30</p>	<p>PCS</p> <p>3</p>	 <p>901899</p> <p>M8x45</p>	<p>PCS</p> <p>6</p>		<p>PCS</p>
		<p>PCS</p>		<p>PCS</p>		<p>PCS</p>		<p>PCS</p>		<p>PCS</p>		<p>PCS</p>

# LAPPSET®

## WALL AND FLOOR

# CLOXX

DATE: 3.8.2010

2(3)

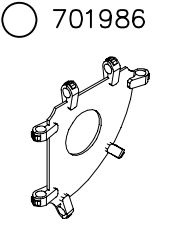
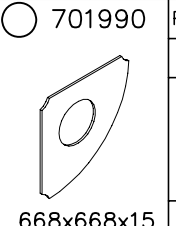
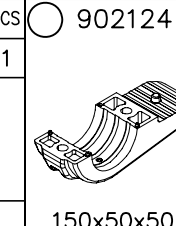
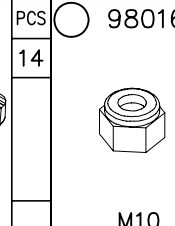
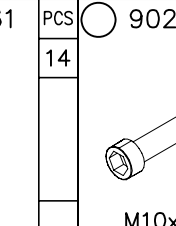
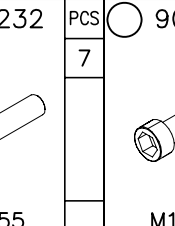
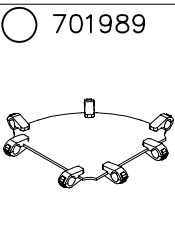
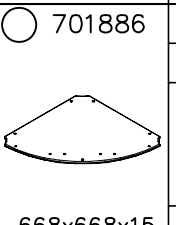
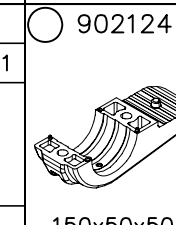
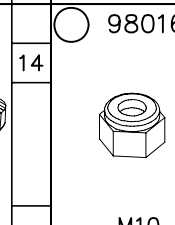
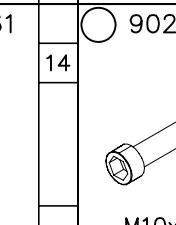
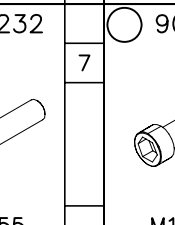
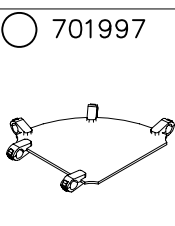
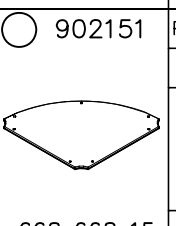
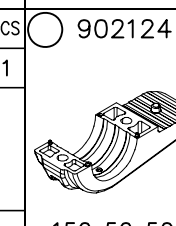
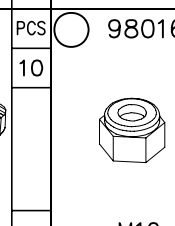
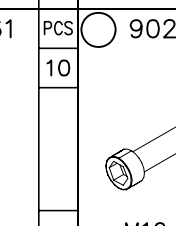
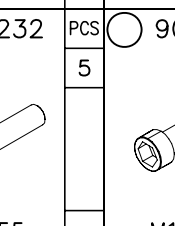
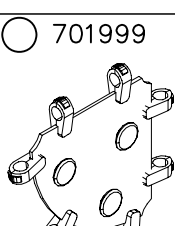
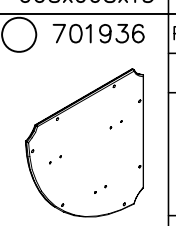
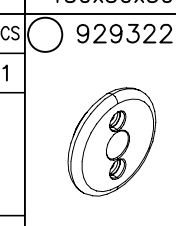
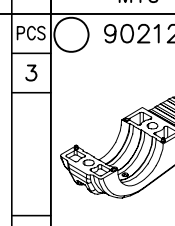
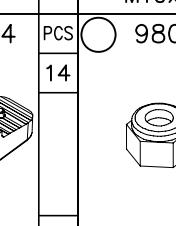
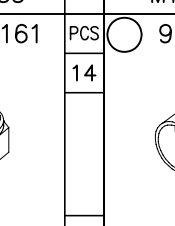
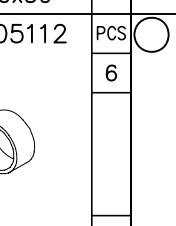
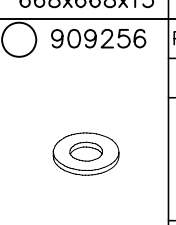
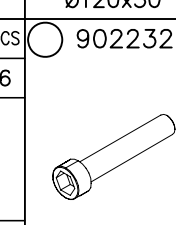
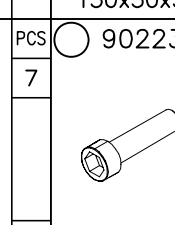
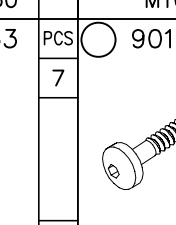
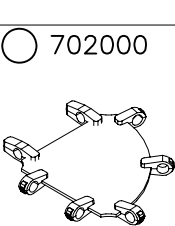
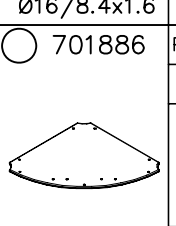
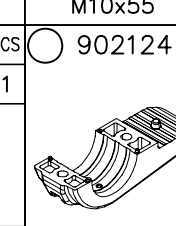
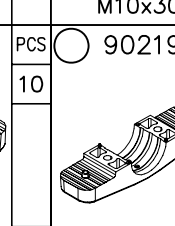
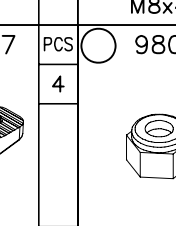
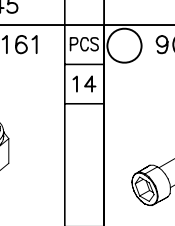
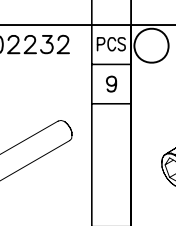
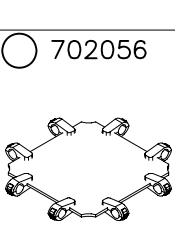
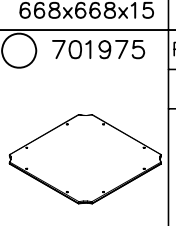
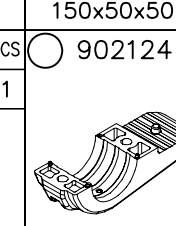
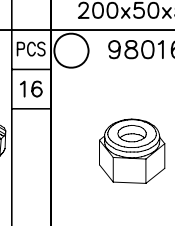
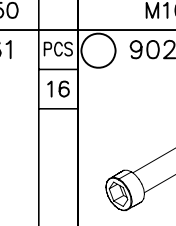
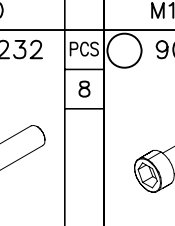
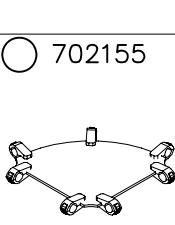
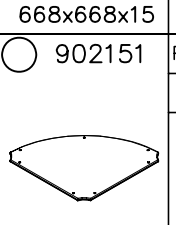
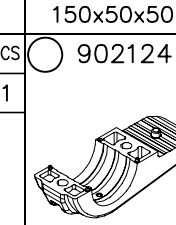
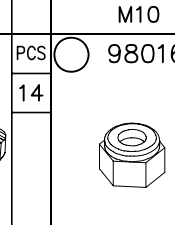
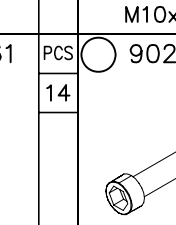
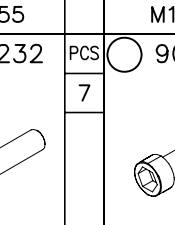
 701986	 668x668x15	PCS 1	 150x50x50	PCS 14	 M10	PCS 14	 M10x55	PCS 7	 M10x30	PCS 7		PCS
 701989	 668x668x15	PCS 1	 150x50x50	PCS 14	 M10	PCS 14	 M10x55	PCS 7	 M10x30	PCS 7		PCS
 701997	 668x668x15	PCS 1	 150x50x50	PCS 10	 M10	PCS 10	 M10x55	PCS 5	 M10x30	PCS 5		PCS
 701999	 668x668x15	PCS 1	 Ø120x30	PCS 3	 150x50x50	PCS 14	 M10	PCS 14	 Ø22	PCS 6	 M8	PCS 6
	 Ø16/8.4x1.6	PCS 6	 M10x55	PCS 7	 M10x30	PCS 7	 M8x45	PCS 6		PCS		PCS
 702000	 668x668x15	PCS 1	 150x50x50	PCS 10	 200x50x50	PCS 4	 M10	PCS 14	 M10x55	PCS 9	 M10x30	PCS 5
 702056	 668x668x15	PCS 1	 150x50x50	PCS 16	 M10	PCS 16	 M10x55	PCS 8	 M10x30	PCS 8		PCS
 702155	 668x668x15	PCS 1	 150x50x50	PCS 14	 M10	PCS 14	 M10x55	PCS 7	 M10x30	PCS 7		PCS

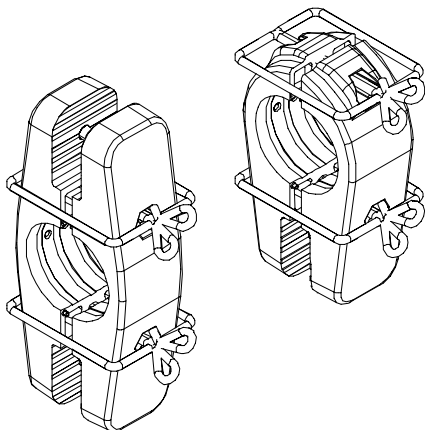
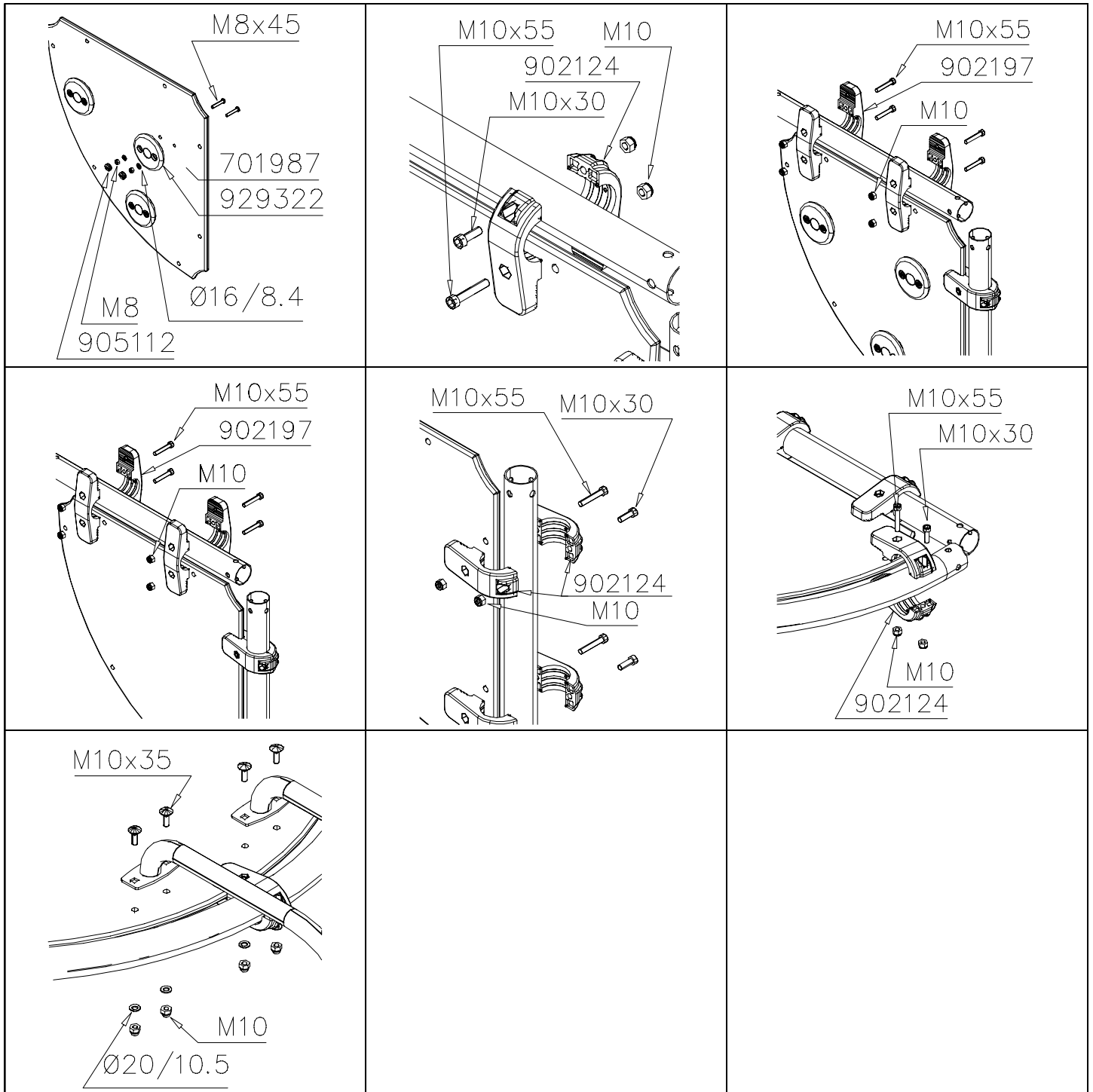

NOTE:  
 Use a wire marked pairs  
 of the same junction.

Huom!  
 Käytä langalla merkittyä  
 paria samassa liitoksessa.

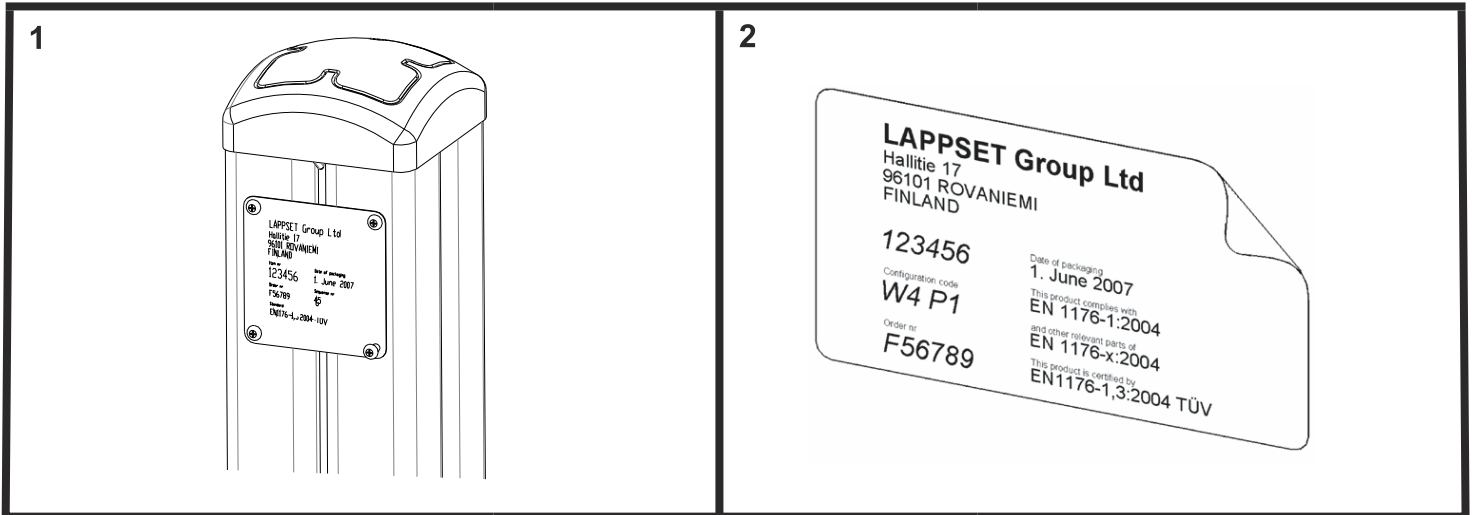

## Tuotekyltti tulee tuotteen mukana yhdellä seuraavista tavoista:

### 1) Metallinen tuotekyltti ja kiinnitysruuvit

- Kiinnitä tuotekyltti ruuveilla tolppaan noin 2 metrin korkeuteen kuvan 1 mukaisesti.

### 2) Tuotekylttitarra

- Puhdista maalattu metalli- tai vaneripinta pölystä ja kosteudesta. Liimaa tarra kuvan 2 mukaisesti.
- Huom. Älä kiinnitä tarraa karheapintaiseen laminaattiin tai maalattuun puuhun.

## Vår produktmärkning levereras på ett av följande sätt:

### 1) Produktskylt i metall

- Fäst skylten med de medföljande skruvarna

### 2) Självhäftande produktetikett

- Rengör den pulverlackerade metallytan eller laminatyten så att den blir fri från smuts och fukt. Fäst etiketten enligt fig. 2.
- Obs! Fäst ej etiketten på detaljer med skrovlig yta eller på målat trä.

## Product label is delivered by one of following ways:

### 1) Metal product label and screws

- Fasten the label with screws.

### 2) Label sticker

- Clean the painted metal or plywood surface from dirt and moisture. Fasten the sticker as shown in the figure 2.
- Note. Do not attach the sticker to rough surfaced laminate or painted wood.

## La plaque d'informations produit est livrée sous l'une de ces 3 formes :

### 1) Plaque métallique et vis

- Fixez la plaque à l'aide des vis.

### 2) Etiquette autocollante

- Avant de coller l'étiquette, nettoyez le composant métallique peint ou la plaque de contreplaqué, de toute saleté. La surface doit être sèche (voir image 2).
- Attention, ne pas coller l'étiquette sur une surface lamellé-collée irrégulière ou sur du bois peint.

## Die Auslieferung des Produktaufklebers erfolgt auf eine dieser Arten:

### 1) Produkt-Schild aus Metall incl. Schrauben

- Die Befestigung des Schildes erfolgt mittels der Schrauben.

### 2) Aufkleber

- Entfernen Sie zunächst Schmutz und Feuchtigkeit vom lackierten Metall bzw. von der Holzoberfläche und bringen Sie den Aufkleber wie im Bild oben rechts beschrieben auf den gesäuberten Untergrund auf.
- Beachten Sie: Bringen Sie den Aufkleber nicht auf raues laminiertes oder lackiertes Holz an.

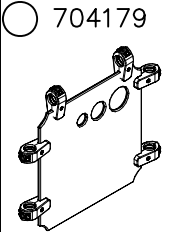
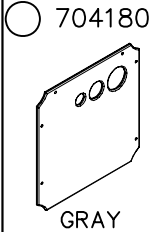
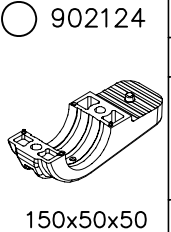
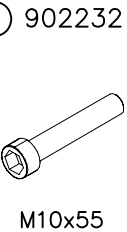
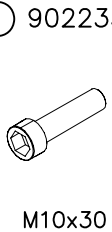
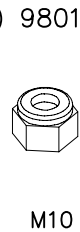
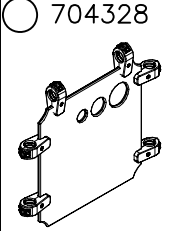
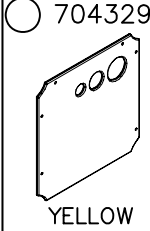
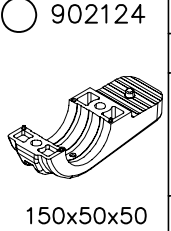
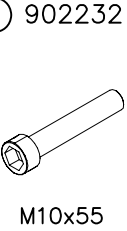
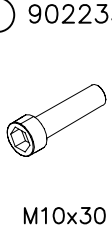
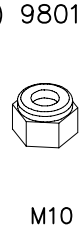
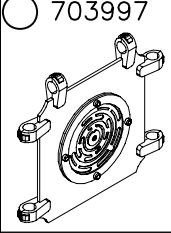
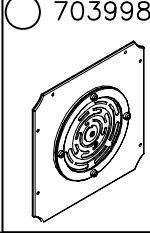
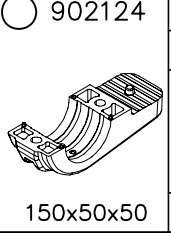
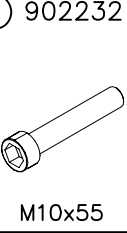
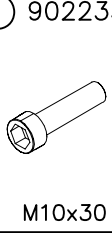
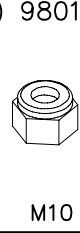
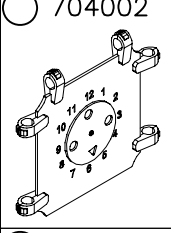
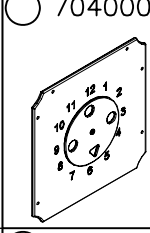
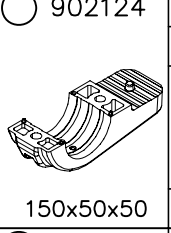
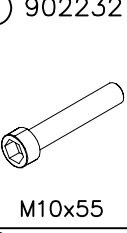
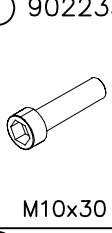
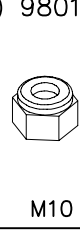
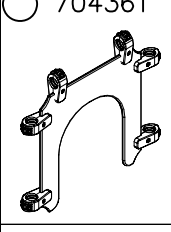
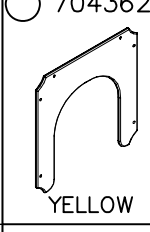
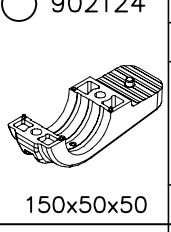
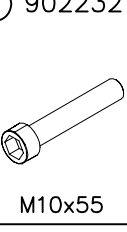
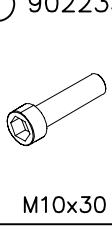
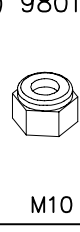
	 GRAY	PCS 1	 150x50x50	PCS 12	 M10x55	PCS 6	 M10x30	PCS 6	 M10	PCS 12		PCS
	 YELLOW	PCS 1	 150x50x50	PCS 12	 M10x55	PCS 6	 M10x30	PCS 6	 M10	PCS 12		PCS
		PCS 1	 150x50x50	PCS 12	 M10x55	PCS 6	 M10x30	PCS 6	 M10	PCS 12		PCS
		PCS 1	 150x50x50	PCS 12	 M10x55	PCS 6	 M10x30	PCS 6	 M10	PCS 12		PCS
	 YELLOW	PCS 1	 150x50x50	PCS 12	 M10x55	PCS 6	 M10x30	PCS 6	 M10	PCS 12		PCS
		PCS		PCS		PCS		PCS		PCS		PCS
		PCS		PCS		PCS		PCS		PCS		PCS
		PCS		PCS		PCS		PCS		PCS		PCS



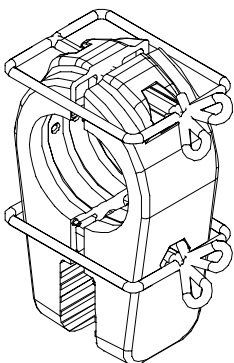
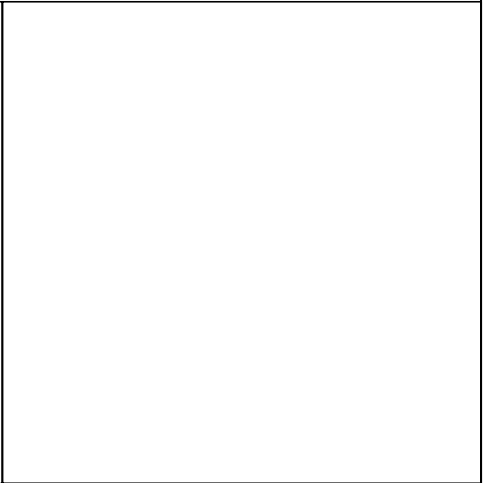
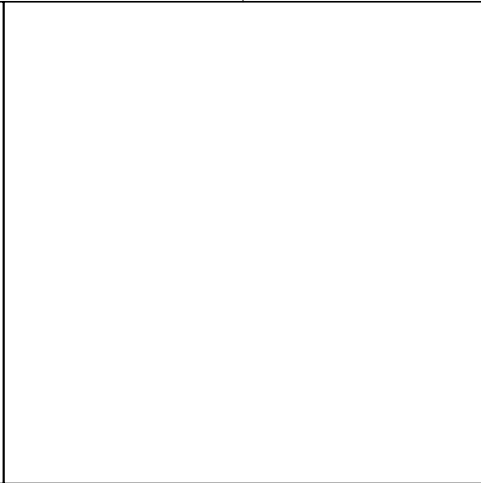
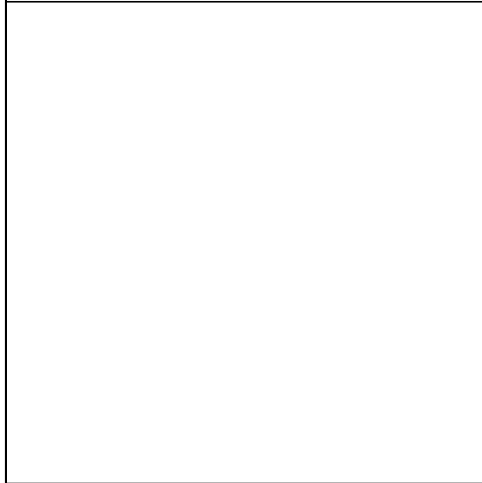
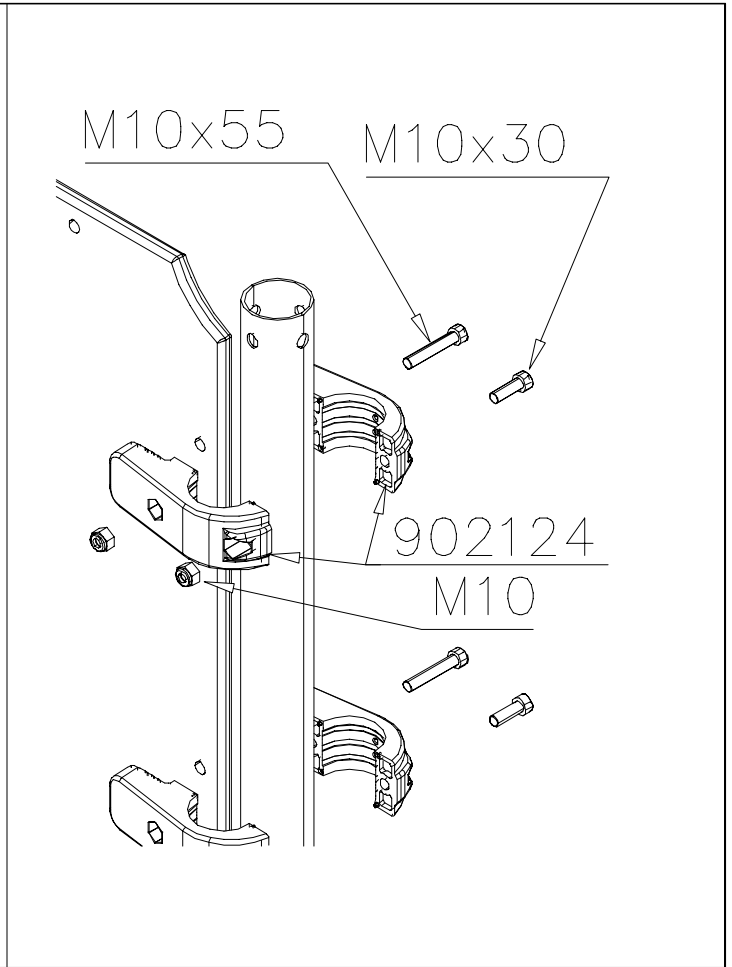
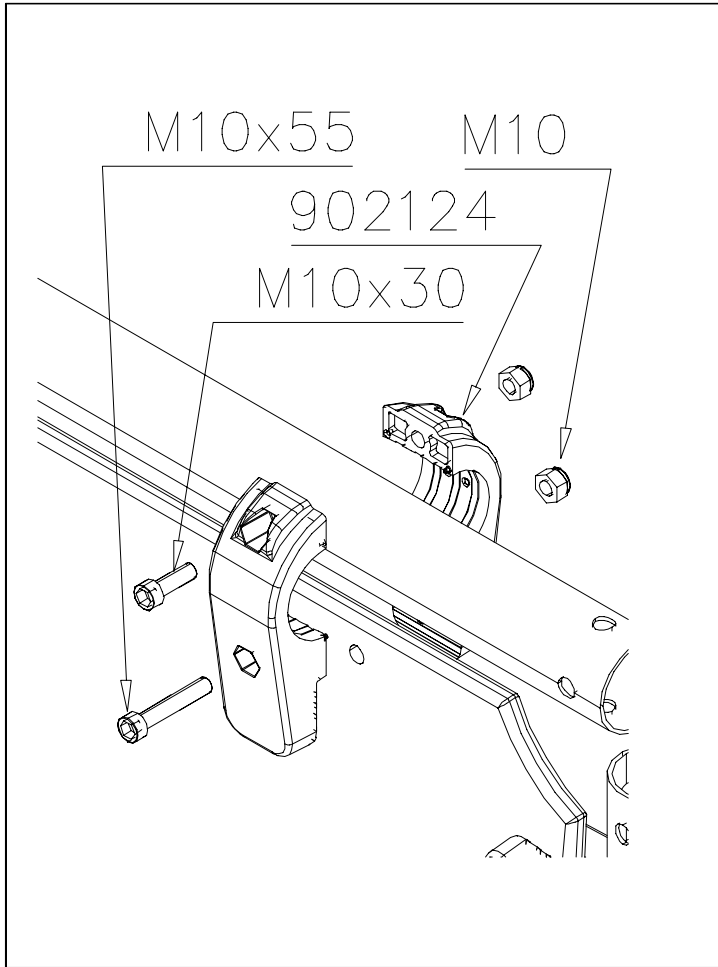

NOTE:  
 Use a wire marked pairs  
 of the same junction.

Huom!  
 Käytä langalla merkittyä  
 paria samassa liitoksessa.