

# LAPPSET®

## FLORA







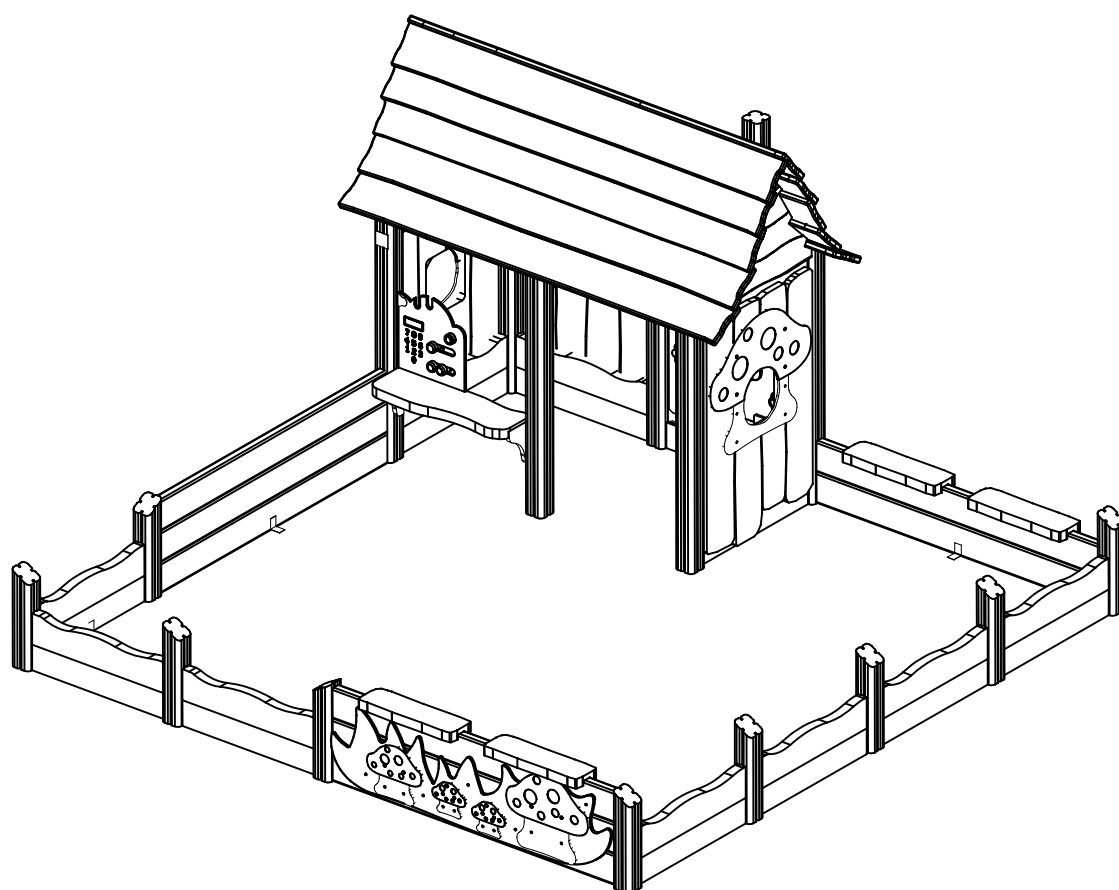



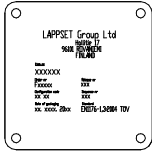
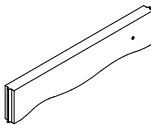
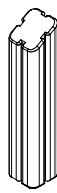
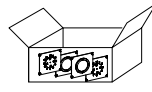

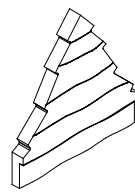
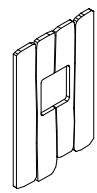

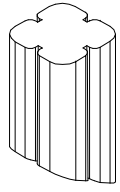
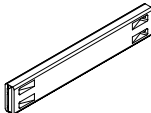
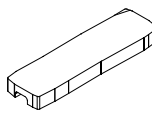
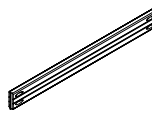
ASENNUSOHJE  
MONTERINGSANSVISNING  
INSTALLATION INSTRUCTION  
AUFBAUANLEITUNG  
NOTICE D'INSTALLATION

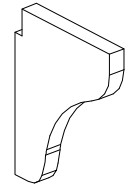
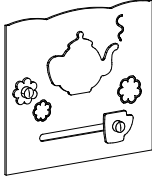
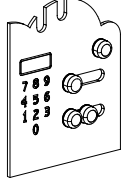
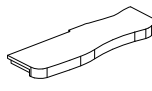
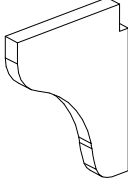
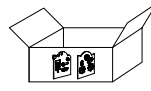
DATE: 9.8.2022

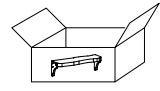
### Q16500

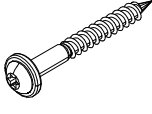
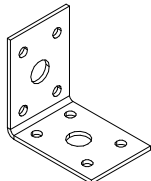
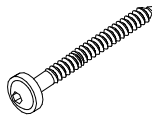
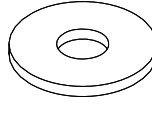
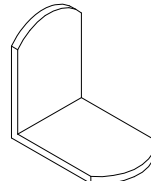

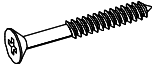
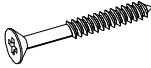
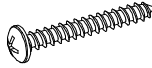
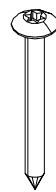
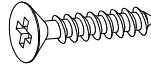
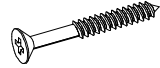
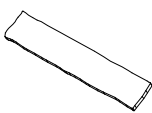
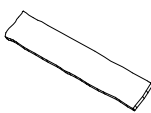
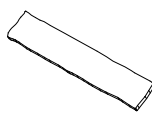
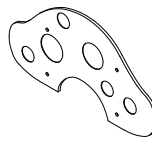
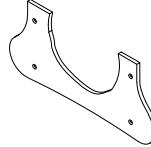
DATE: 9.8.2022

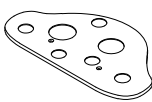
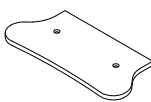
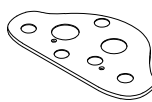
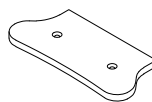
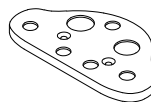
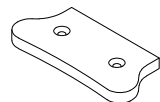
702286  65x65	PCS 1	705211  L=724	PCS 11	705381  L 450	PCS 9	706778  	PCS 1	708374  68x690x704	PCS 3	708437  	PCS 3
708469  93x93x200	PCS 1	708746  L 724	PCS 11	708752  45x145x500	PCS 4	708767  45x145x1505	PCS 8	708778  93x93x1200	PCS 6	709350-705  20x154x200	PCS 1
709358-707  79x640x702	PCS 1	709372-707  423x351	PCS 1	709374  45x224x702	PCS 1	709400-705  20x154x200	PCS 1	709402  	PCS 1	709476  	PCS 1
900240  Ø8x70	PCS 8	902434  50x50x35x2	PCS 10	903093  Ø8x90	PCS 133	905051  Ø24/8.4	PCS 6	905071  113x10x3	PCS 6	909628  M10x100	PCS 16
980100  Ø5x60	PCS 60	980111  Ø4x40	PCS 40	980114  Ø4x20	PCS 4	980128  Ø7x40	PCS 6	980129  5X35	PCS 34	980140  4,5X45	PCS 32
P13451-607  28x200x2000	PCS 8	P13455-607  28x200x2000	PCS 1	P13456-607  28x200x2000	PCS 1	P16053  28x200x2000	PCS 3	P16054  28x200x2000	PCS 3	P16057  28x200x2000	PCS 2
P16060  28x200x2000	PCS 2	P16061  28x200x2000	PCS 2	P16062  28x200x2000	PCS 2	P16063  28x200x2000	PCS 2	P16068  28x200x2000	PCS 4	P16070  28x200x2000	PCS 4

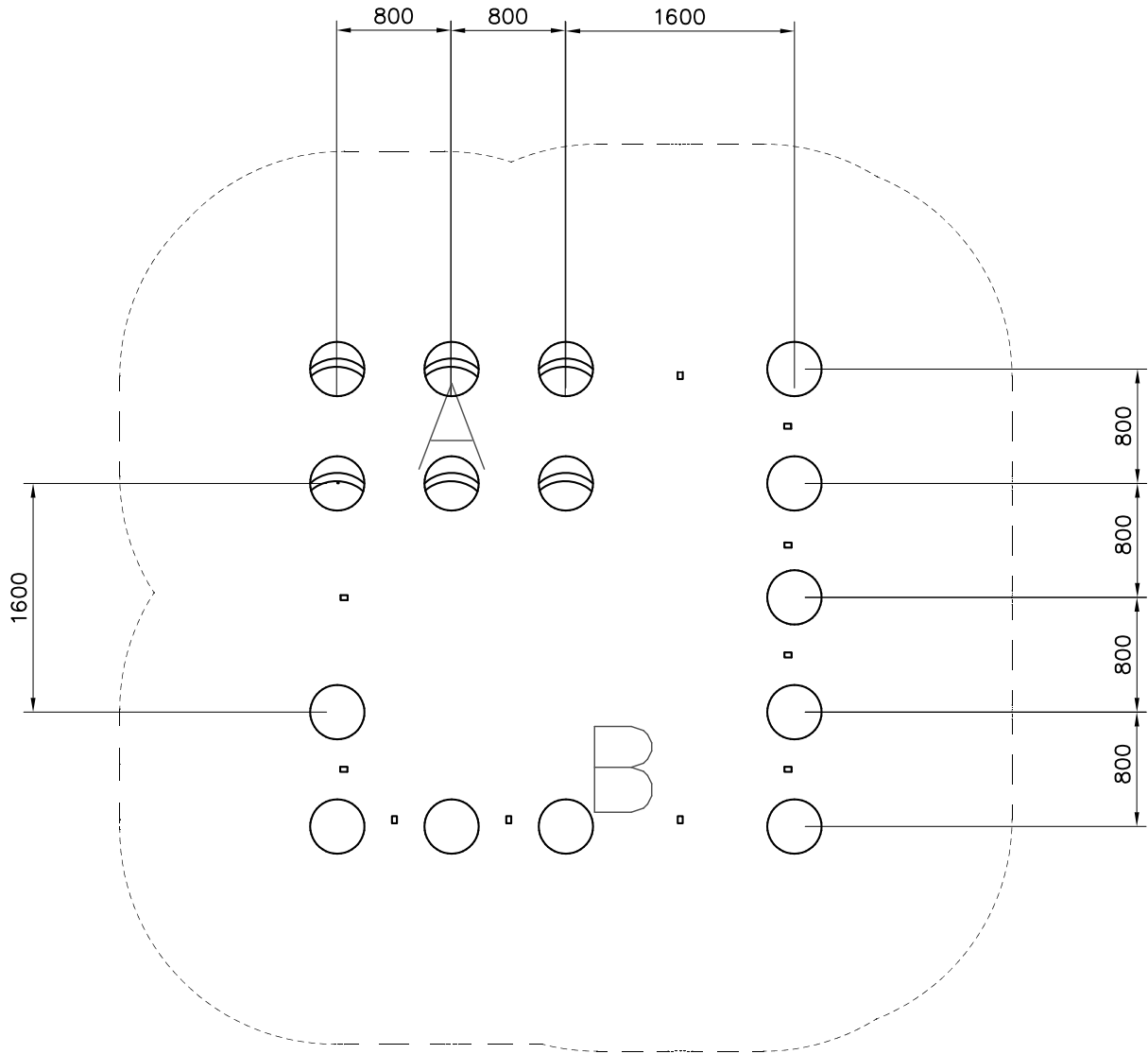
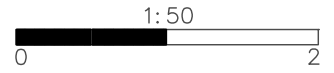

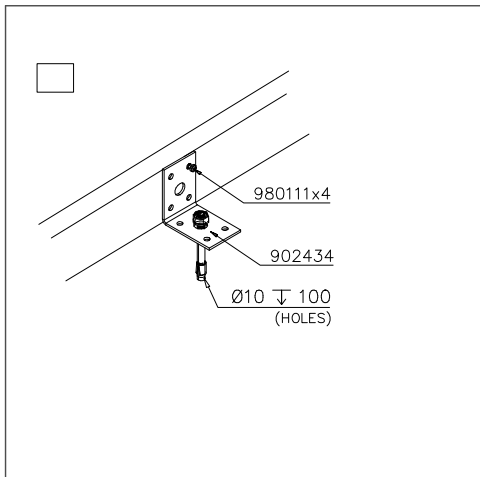
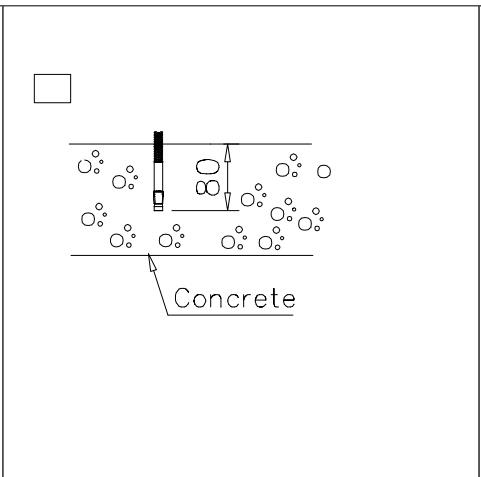
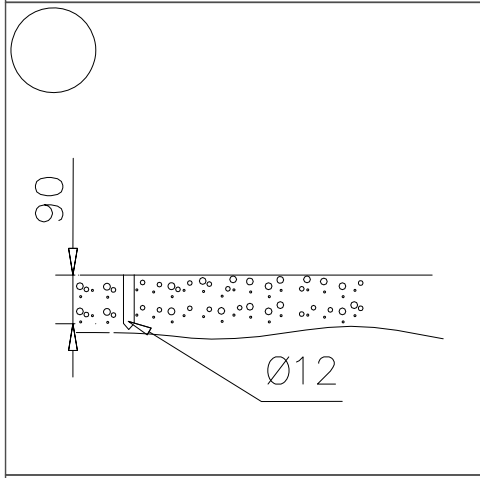
----- Falling Space 36.9 m<sup>2</sup>  
Max Falling Height 460 mm



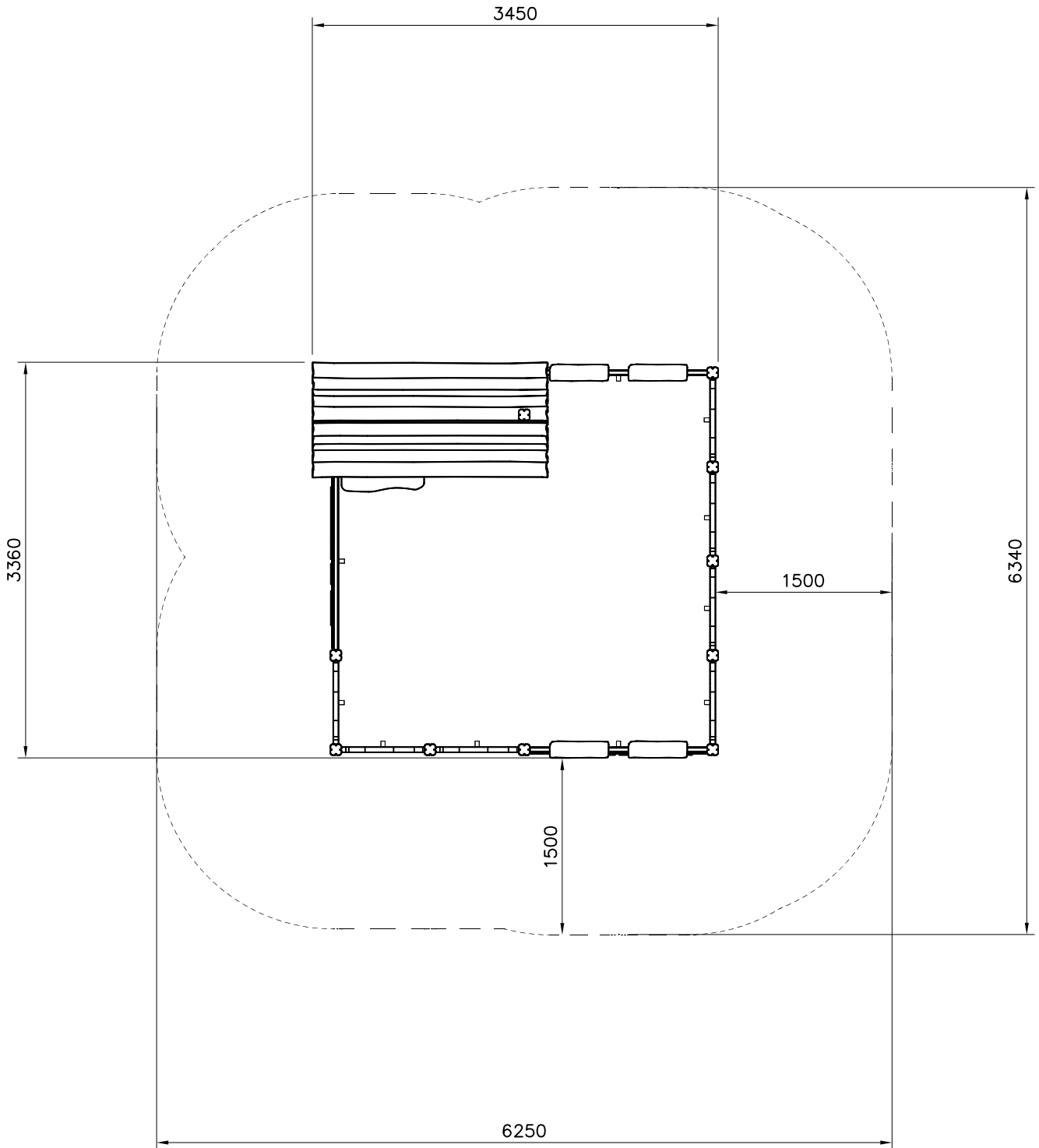
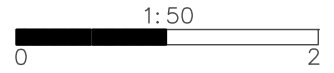

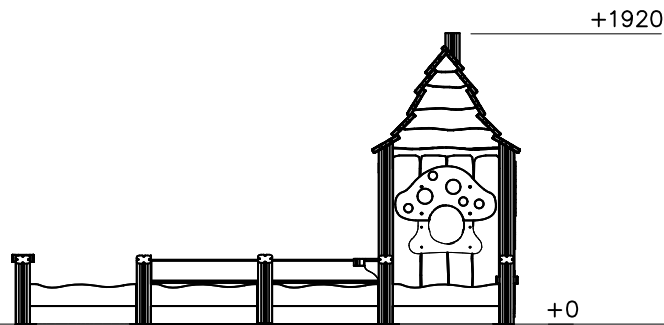
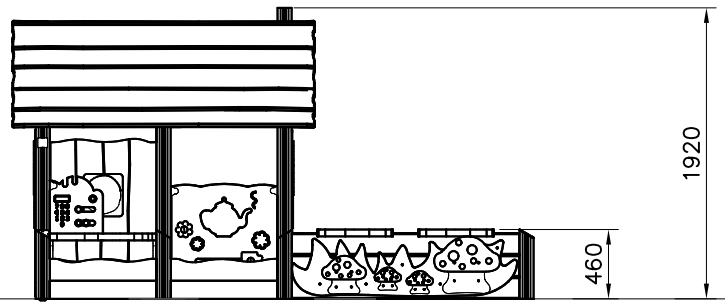

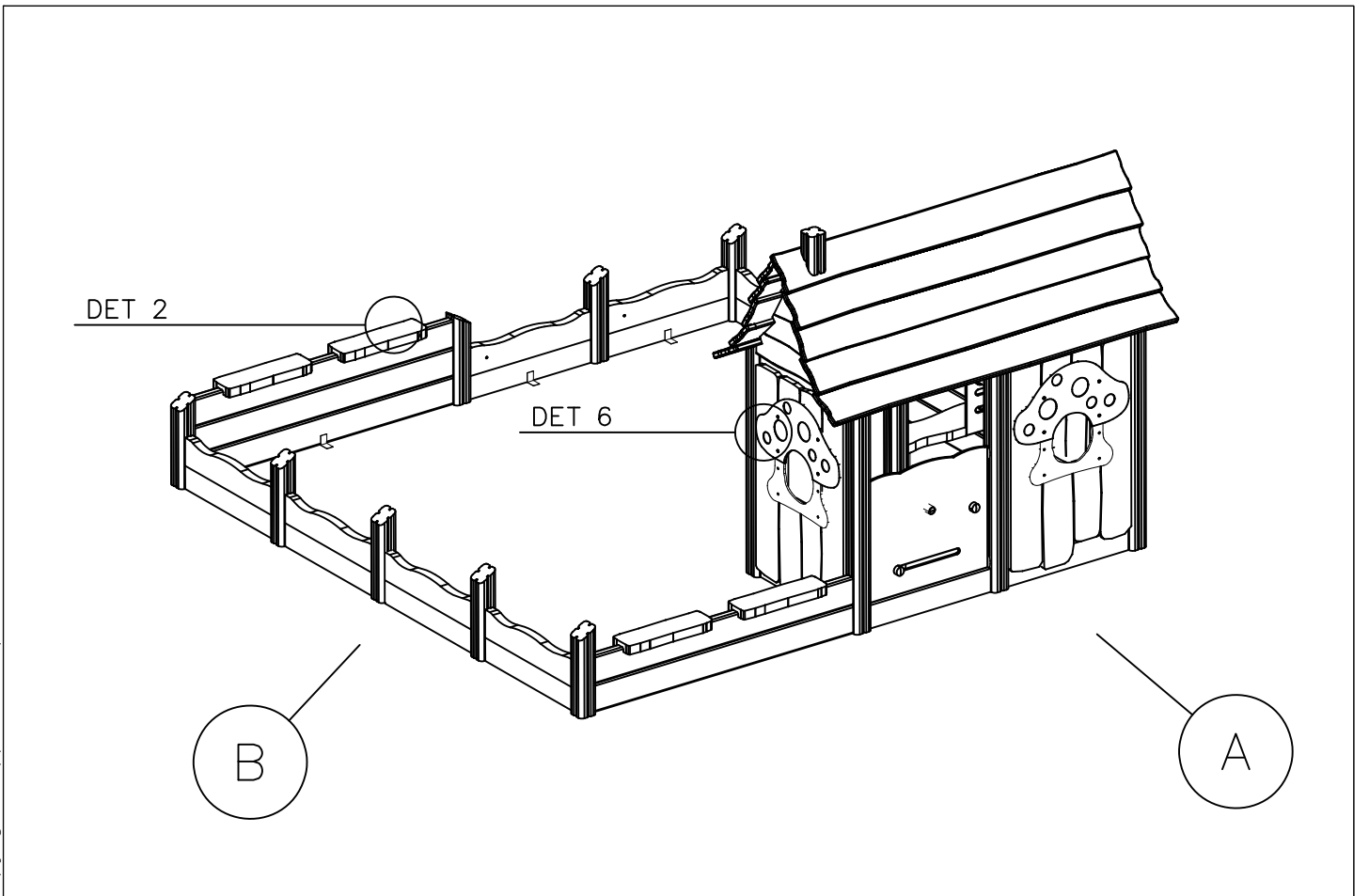
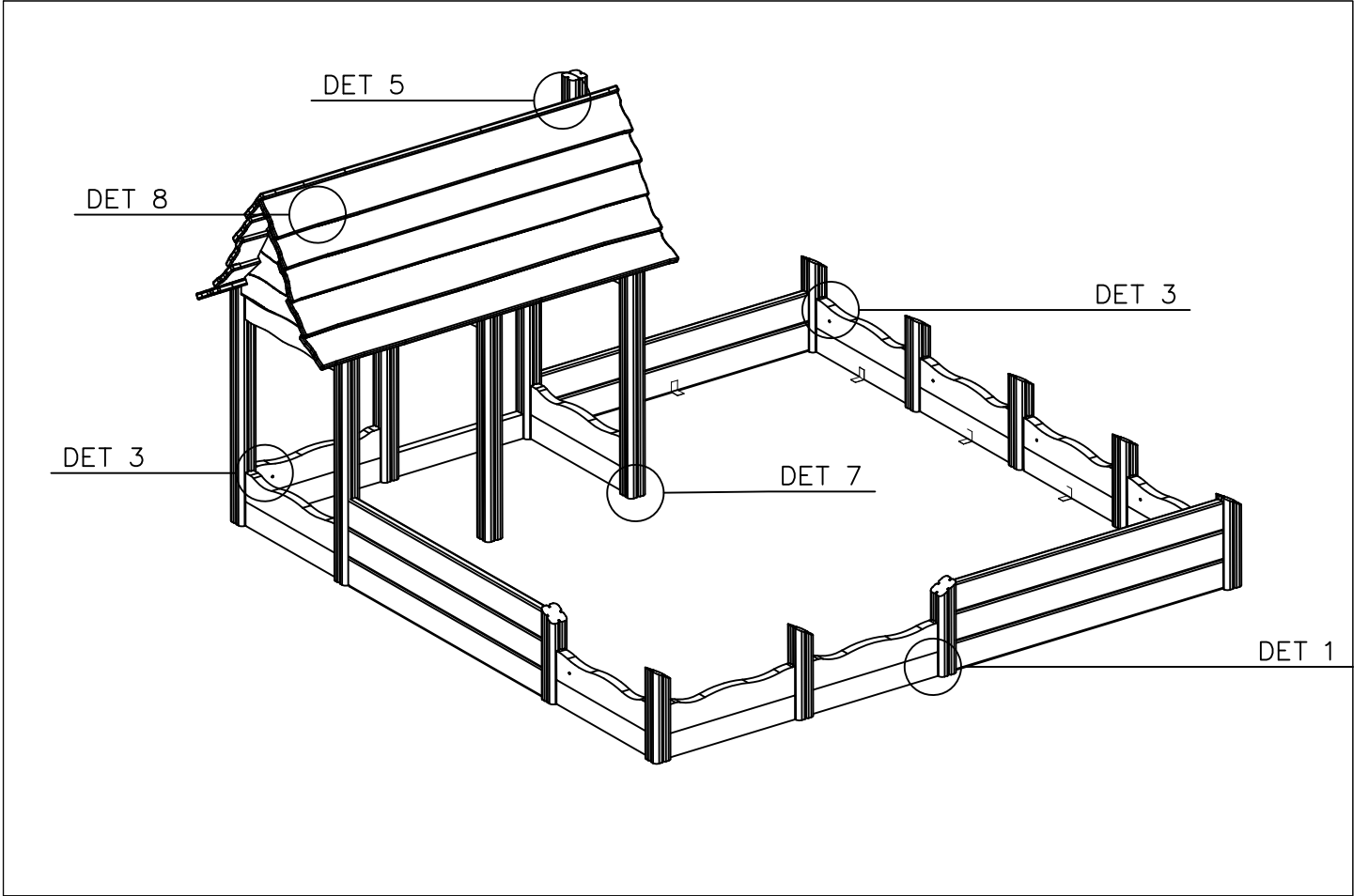
<p>DET 1</p>	<p>DET 2</p>	<p>DET 3</p>	<p>DET 4</p>
<p>DET 5</p>	<p>DET 6</p>	<p>DET 7</p>	
<p>DET 8</p>	<p>DET 9</p>	<p>DET 10</p>	



DET 11

P16057 – P16060 – P16061 – P16062 – P16063 – P16068 – P16070

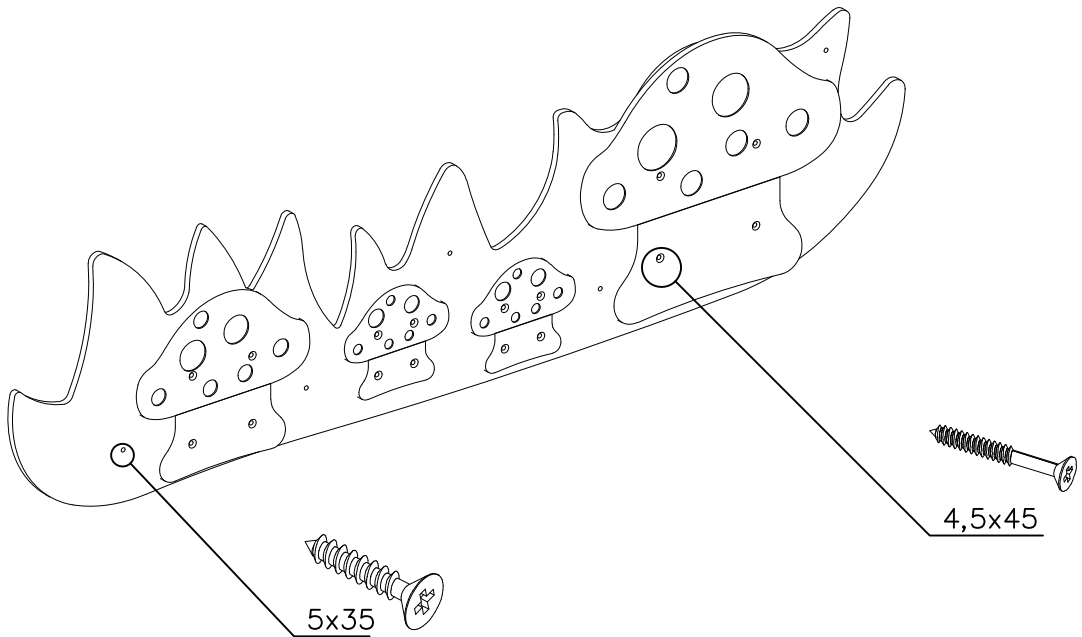

P16056 – P16058 – P16059 – P16060 – P16061 – P16062 – P16063 – P16068 – P16070

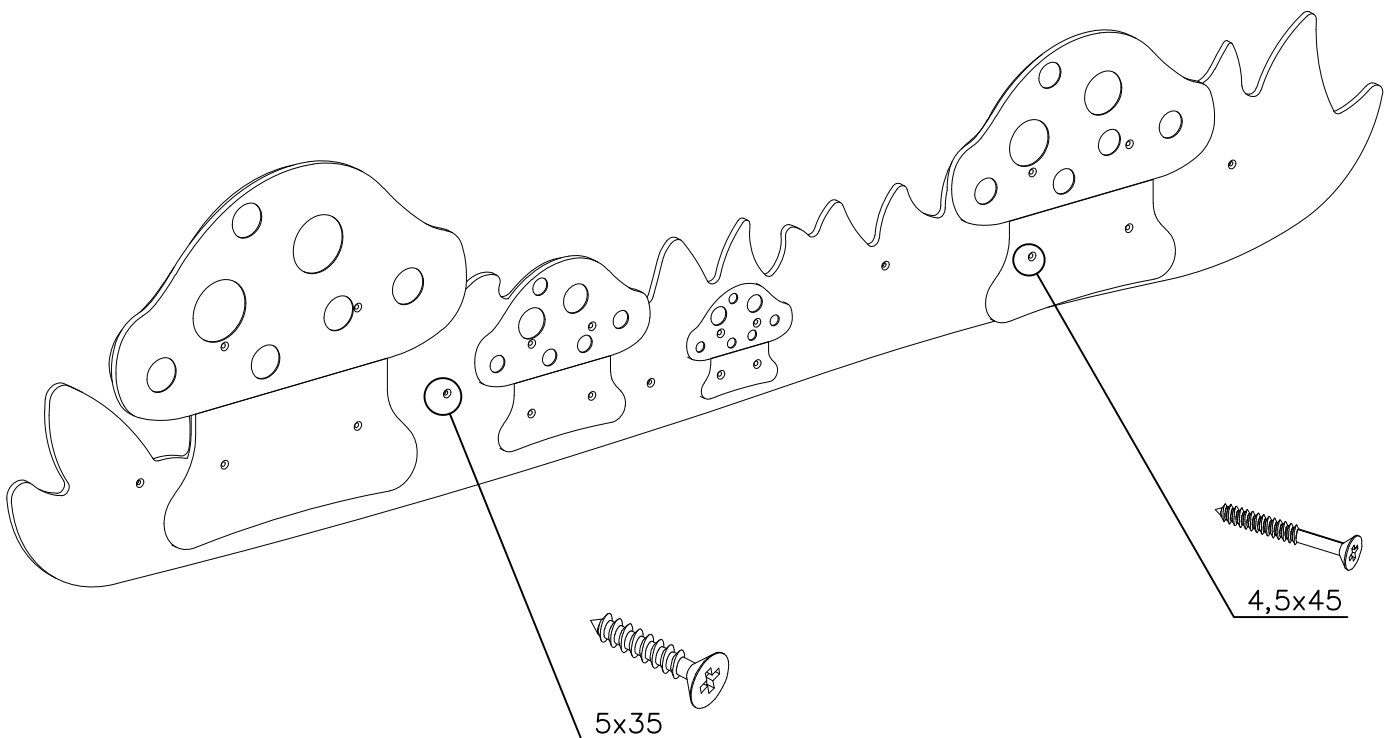

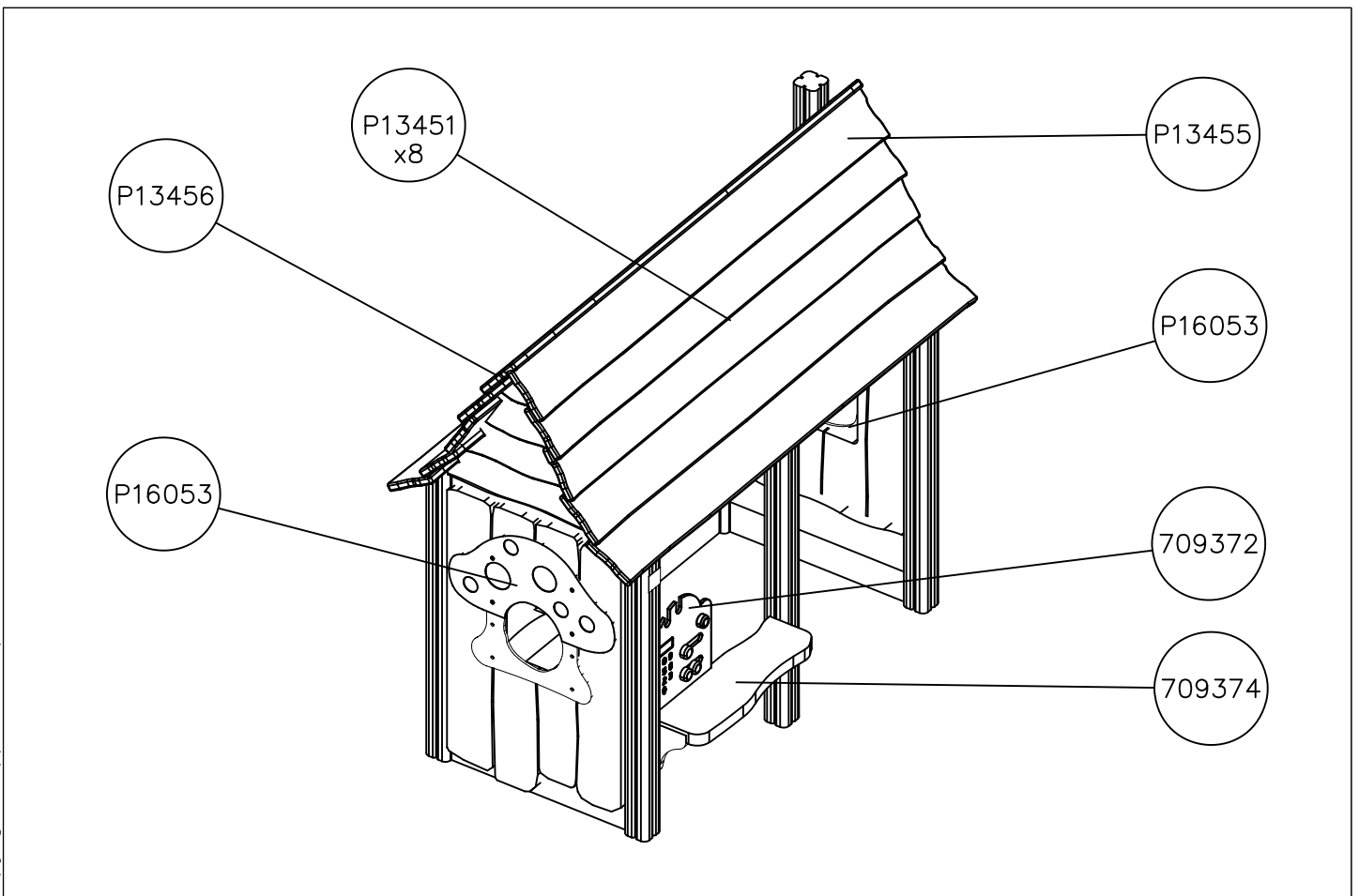
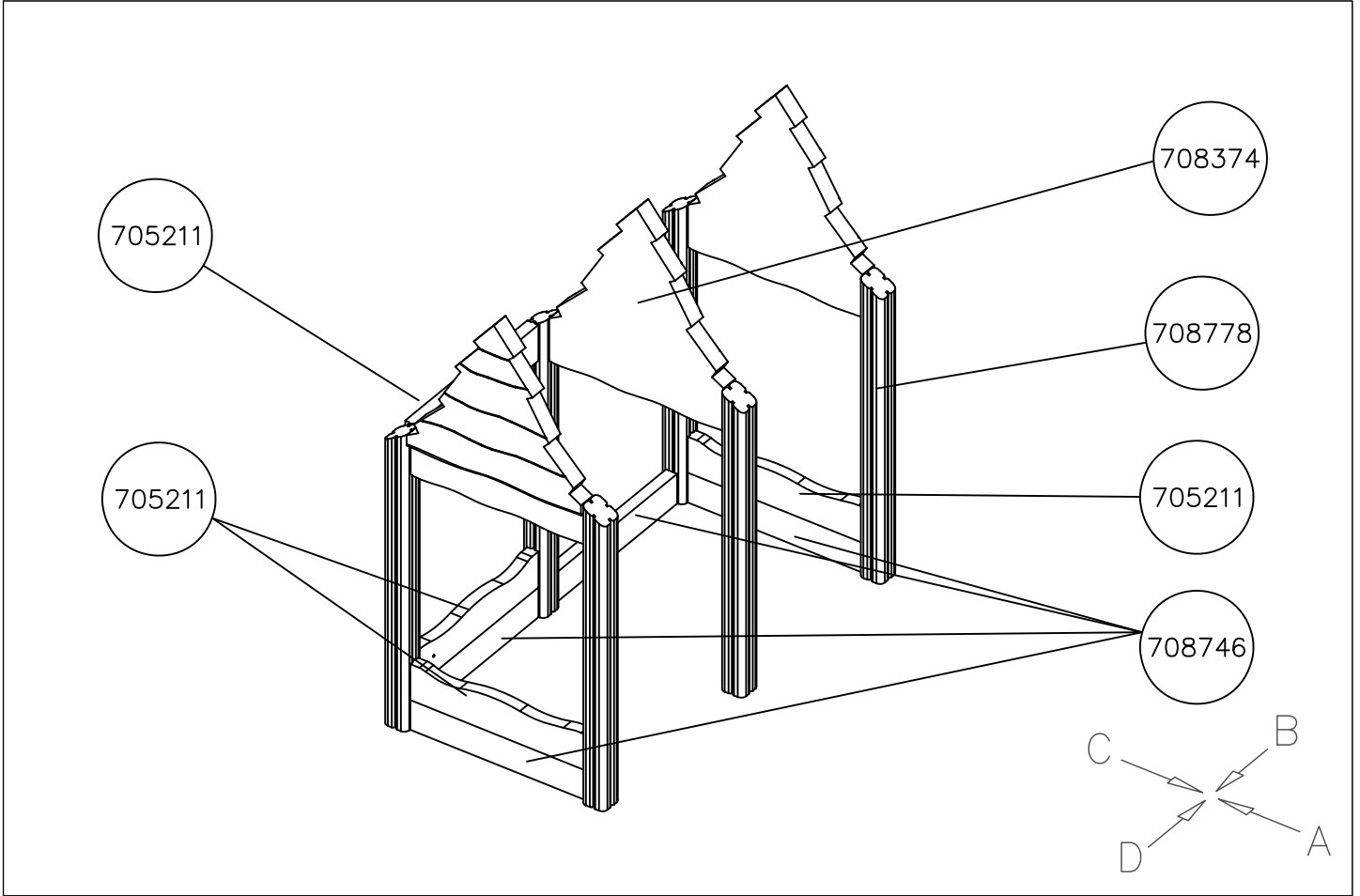

DATE: 9.8.2022

1:50

A

B

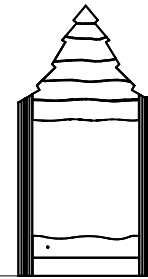
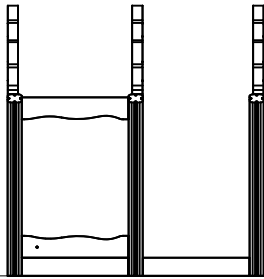

C

D

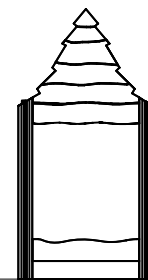
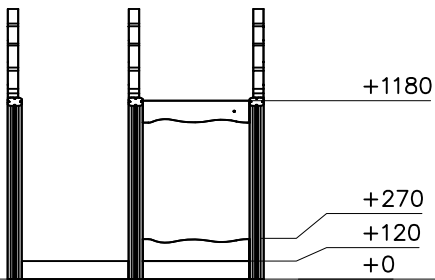

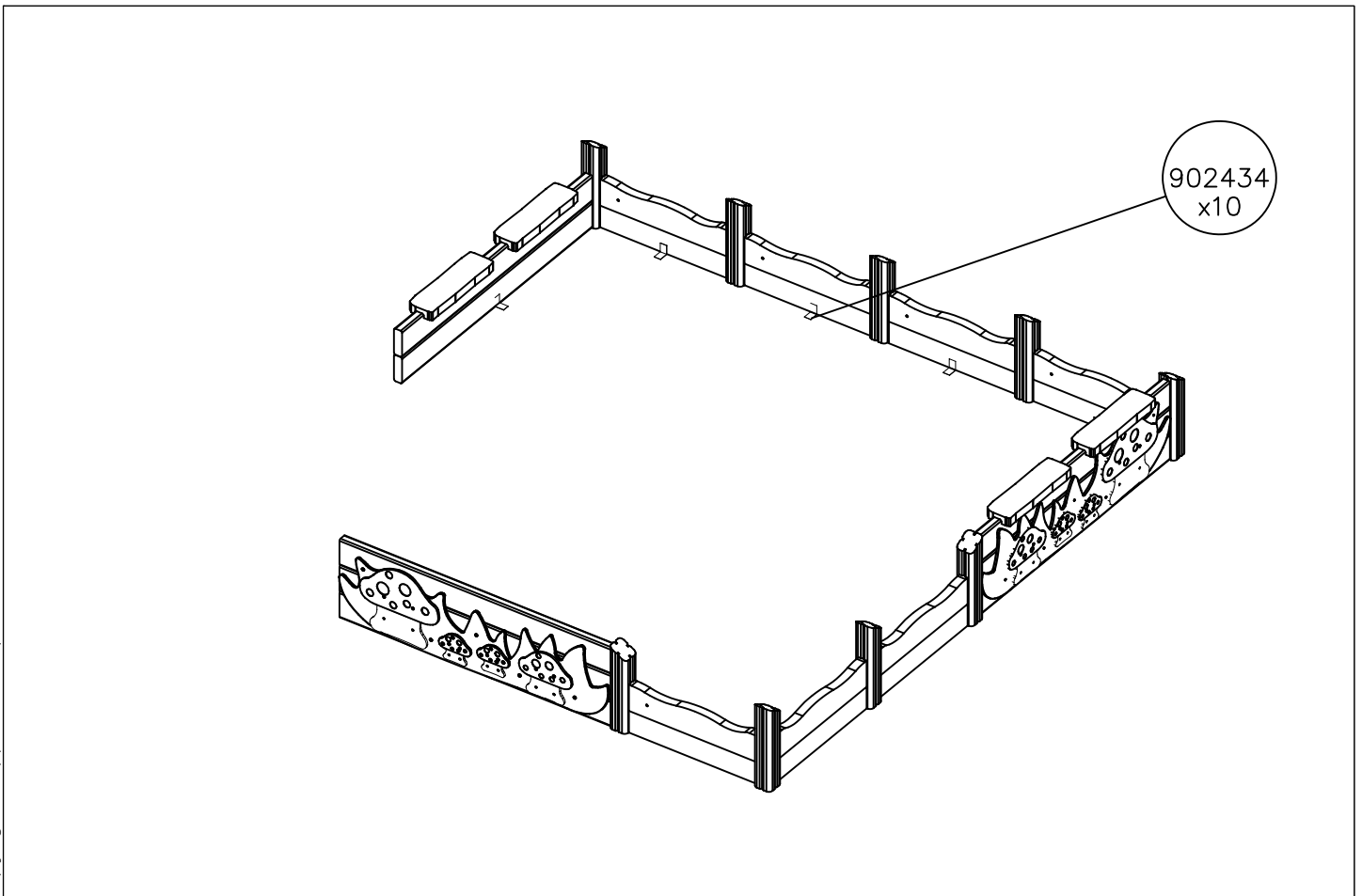
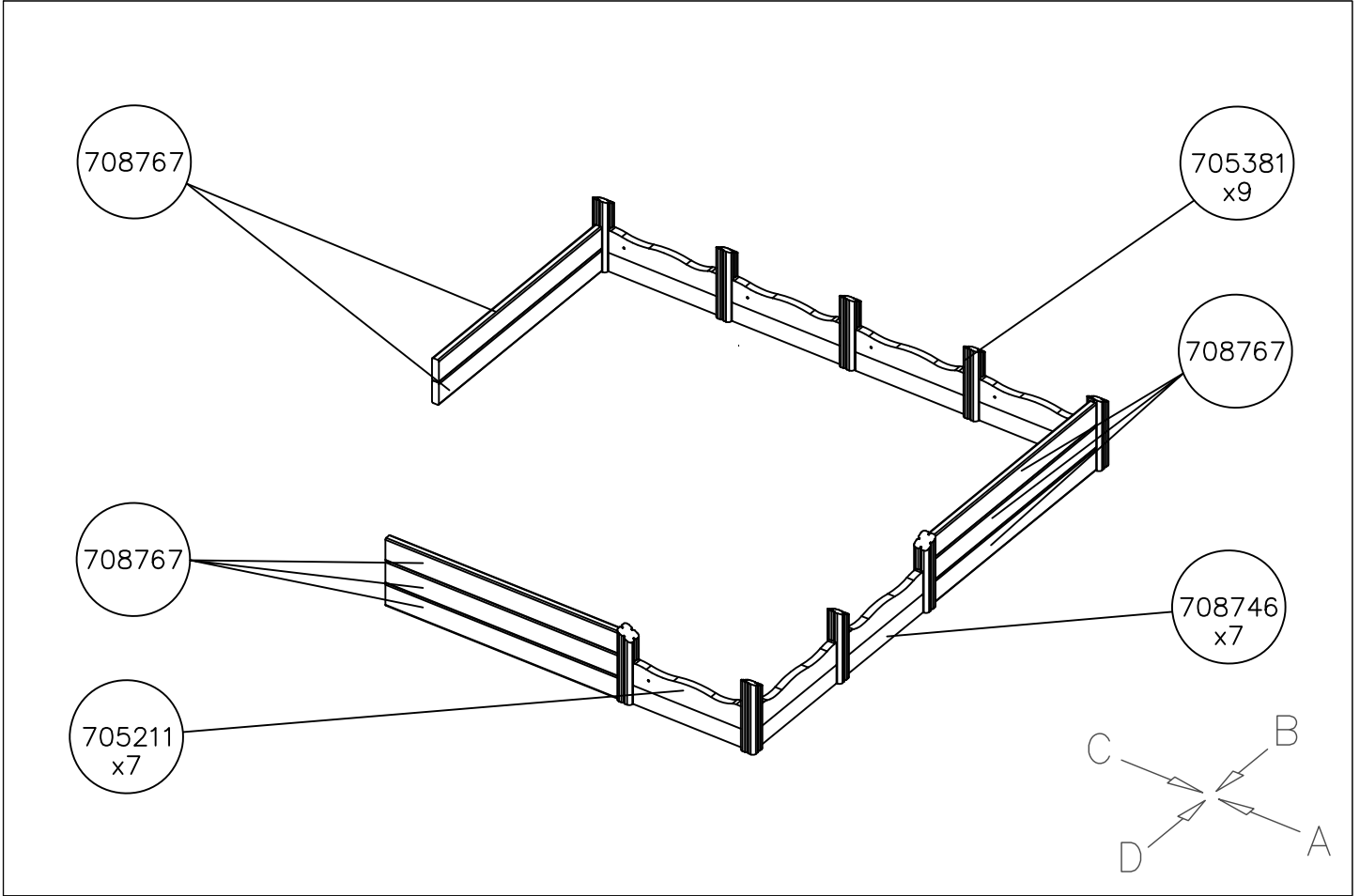

DATE: 9.8.2022

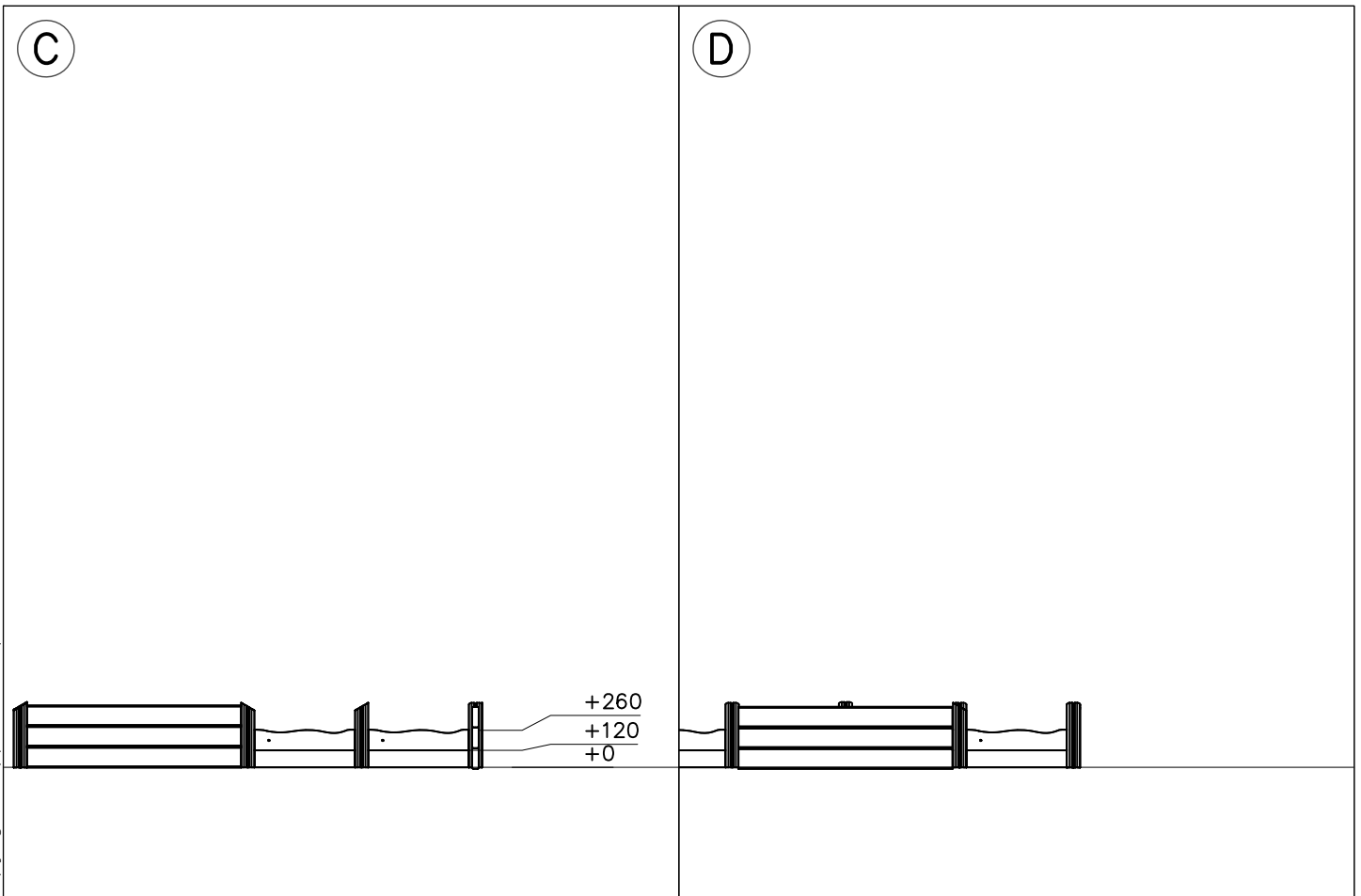
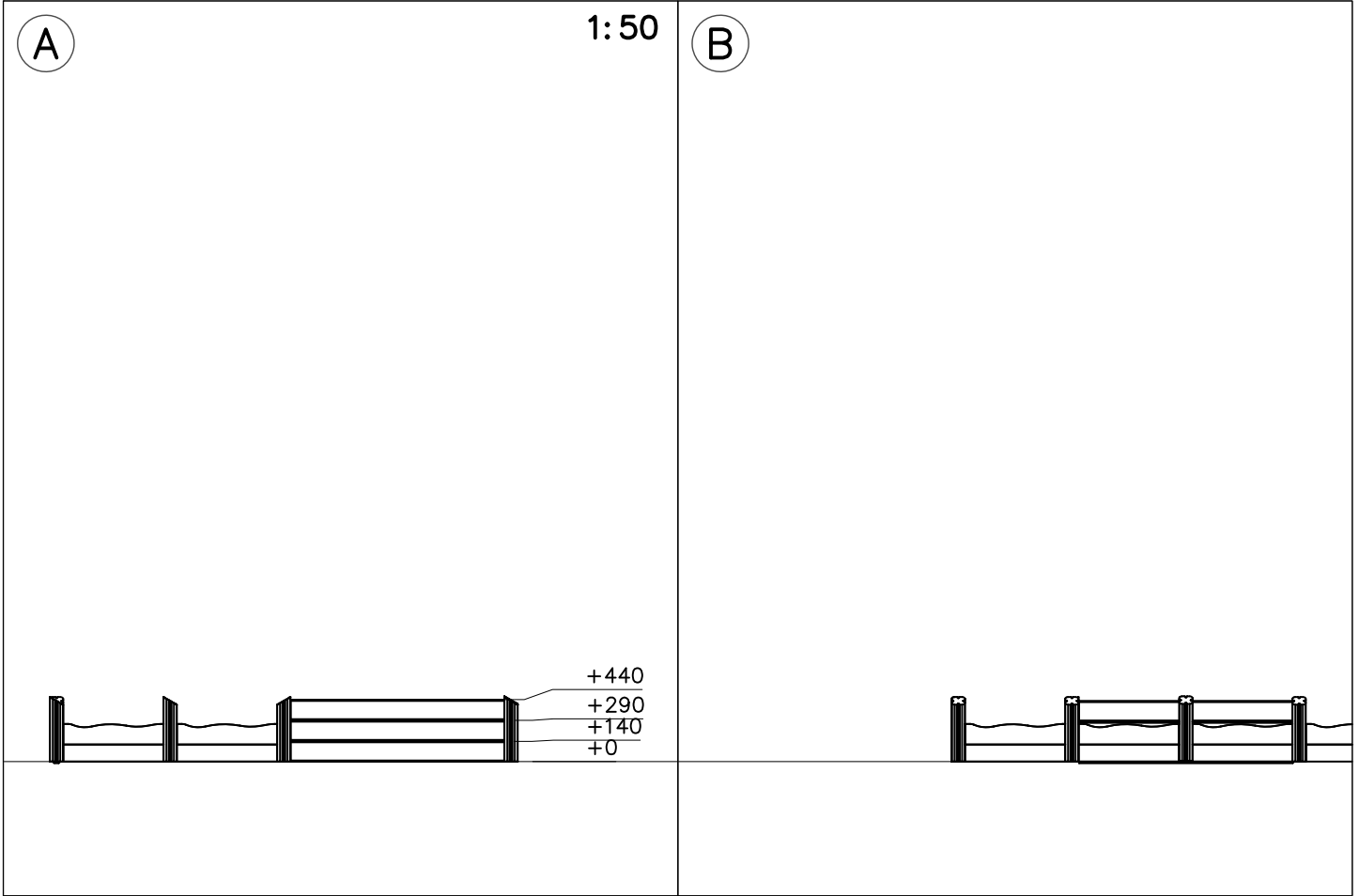

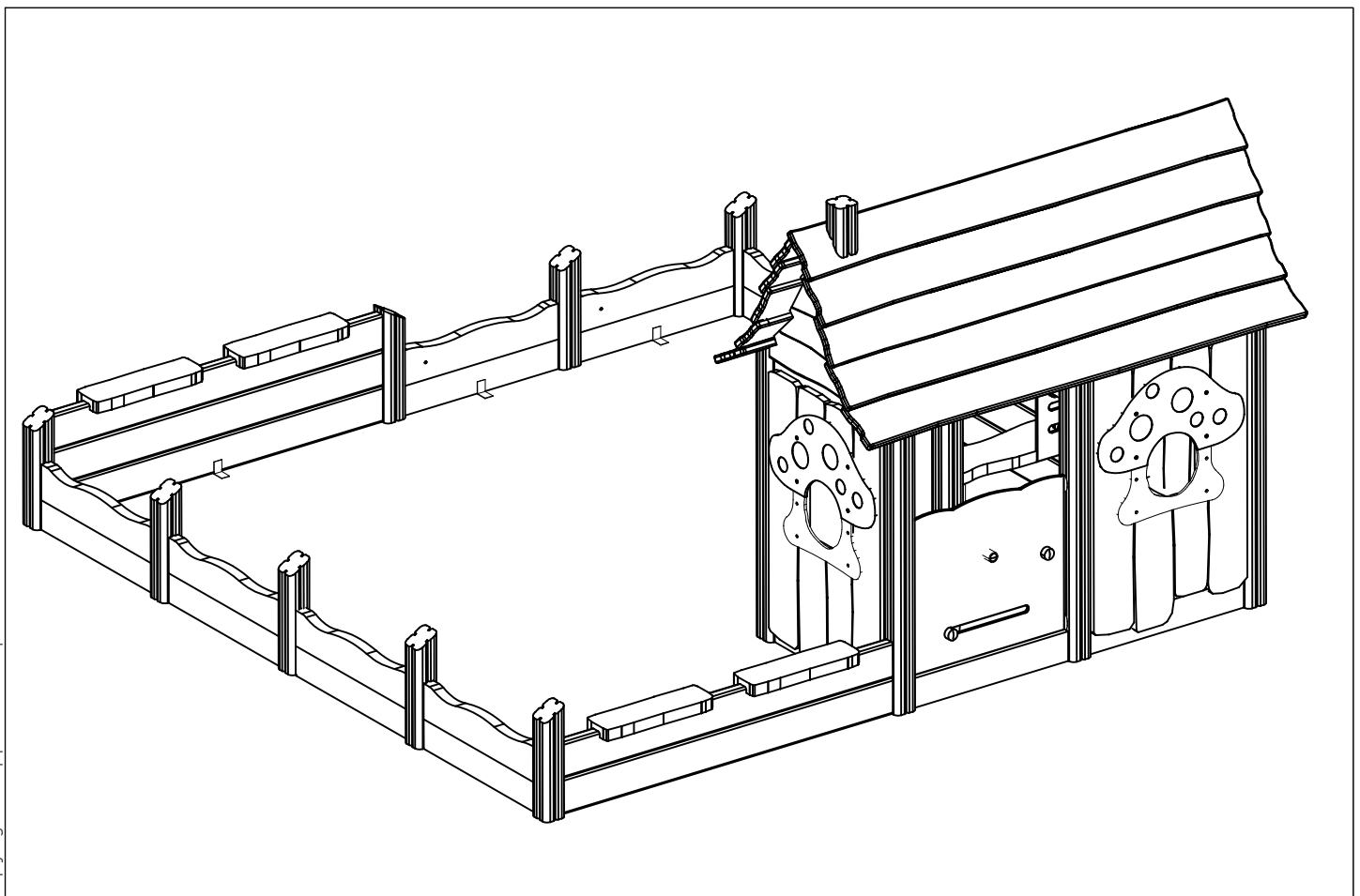
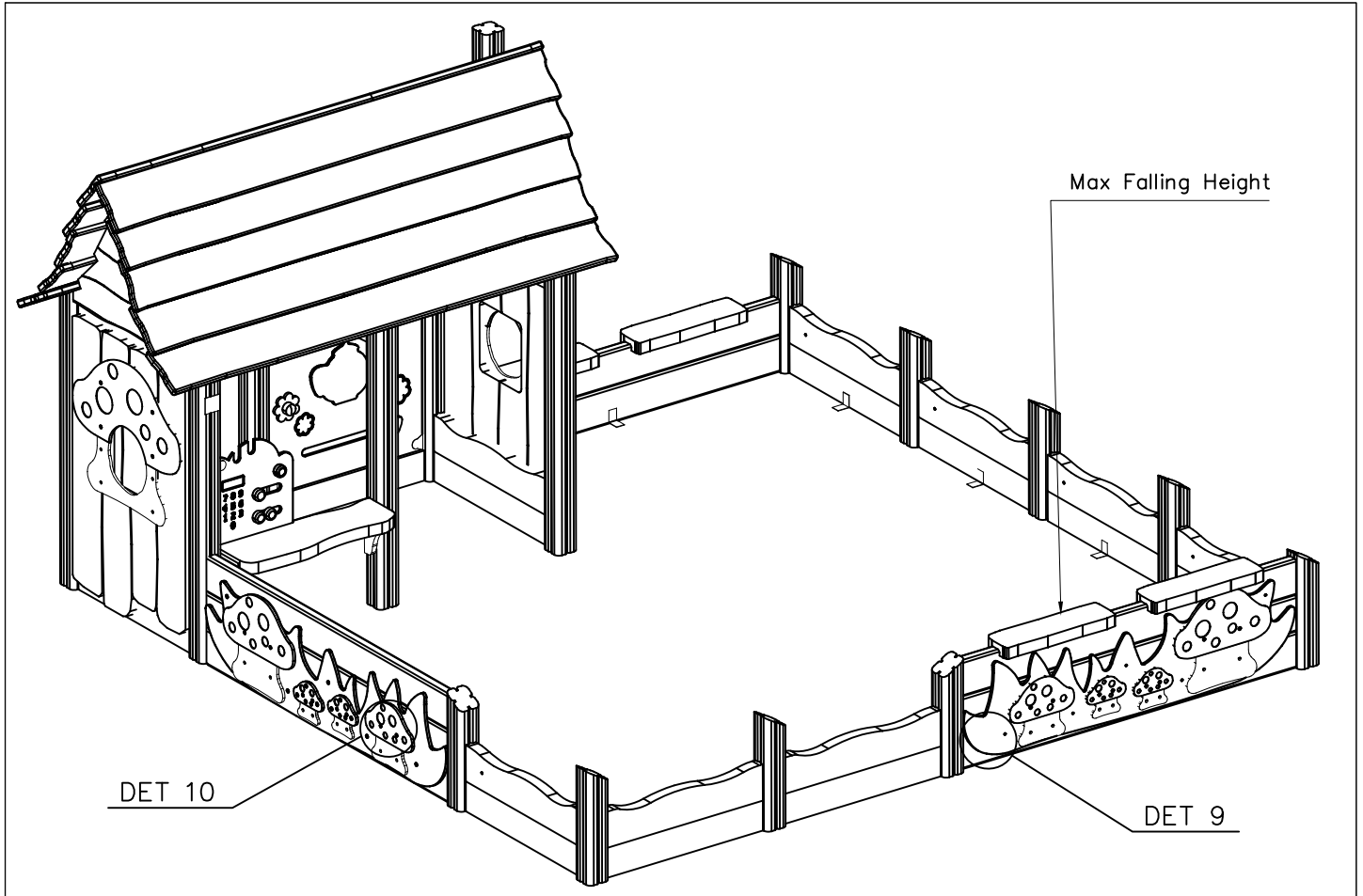

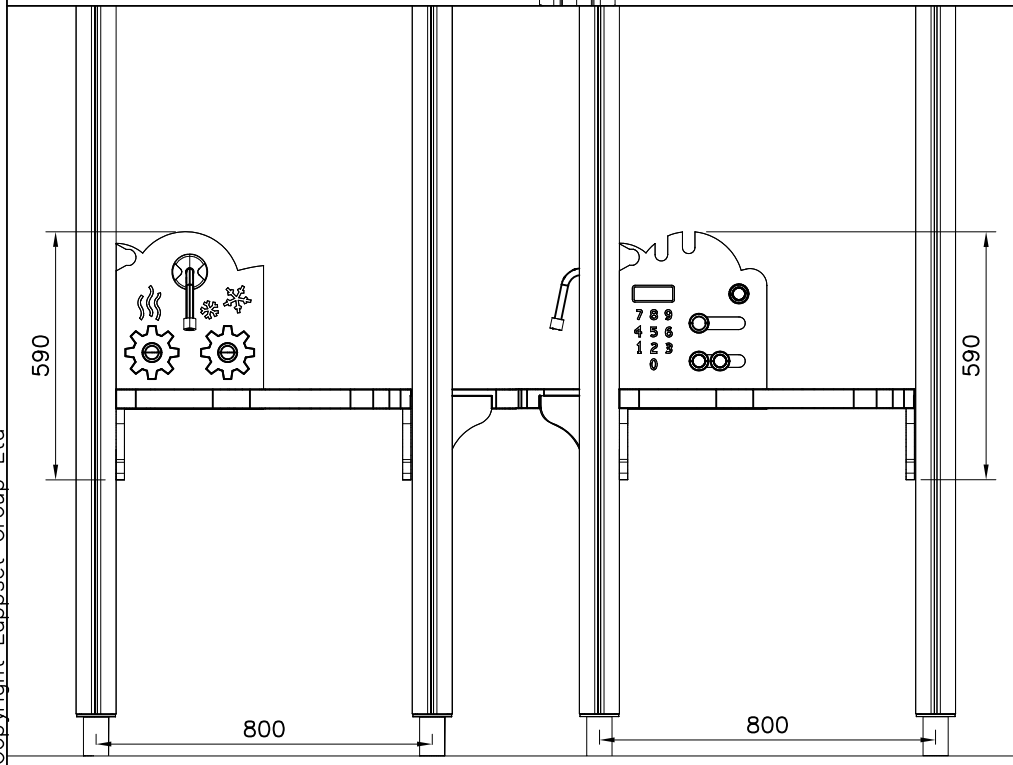
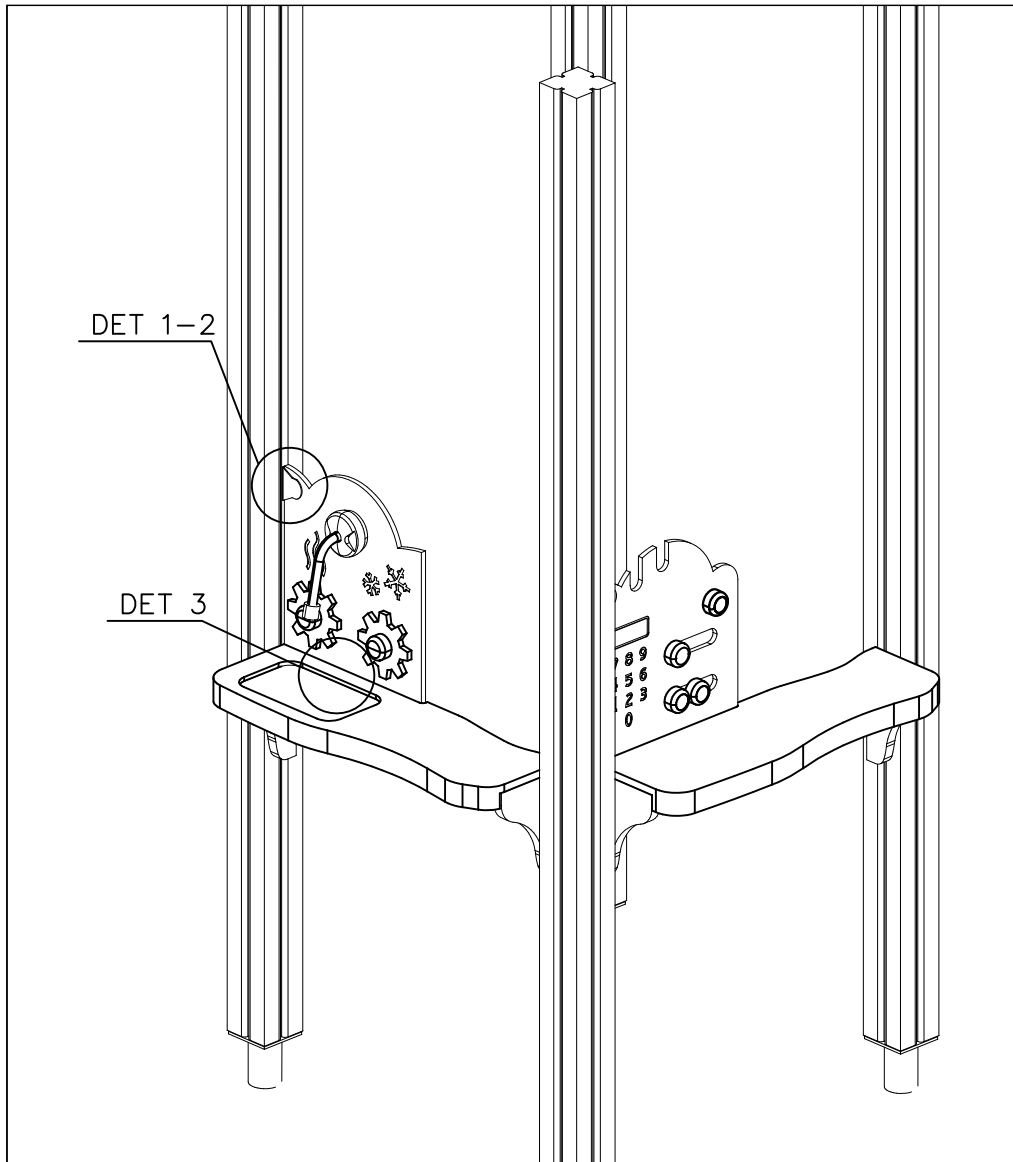

①	903176	PCS	②	909850	PCS
		1			1
				M8x25	
③	980128	PCS	④	909256	PCS
		3			2
	Ø7x40			Ø16/8.4	
⑤	909633	PCS	⑥	980123	PCS
		1			1
	M8			Ø7x60	
		PCS			PCS
		PCS			PCS
		PCS			PCS
		PCS			PCS
		PCS			PCS

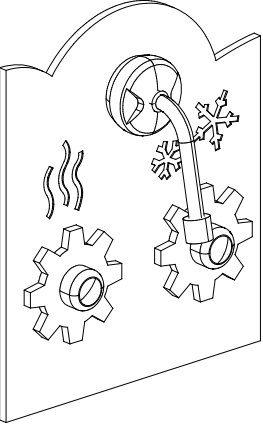
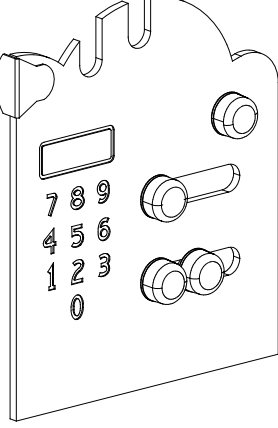
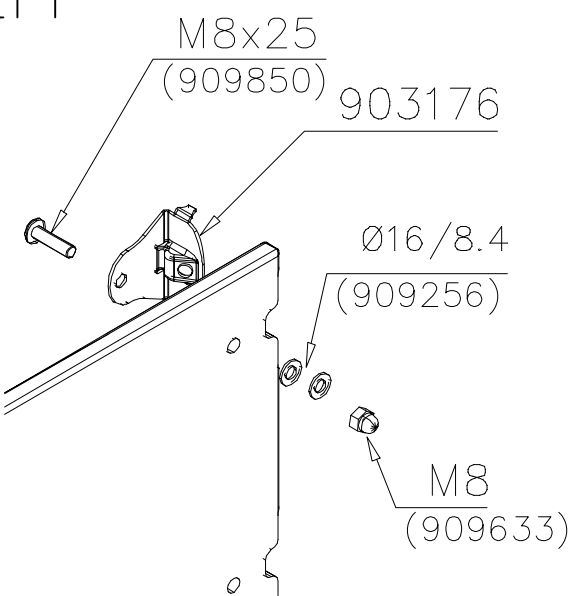
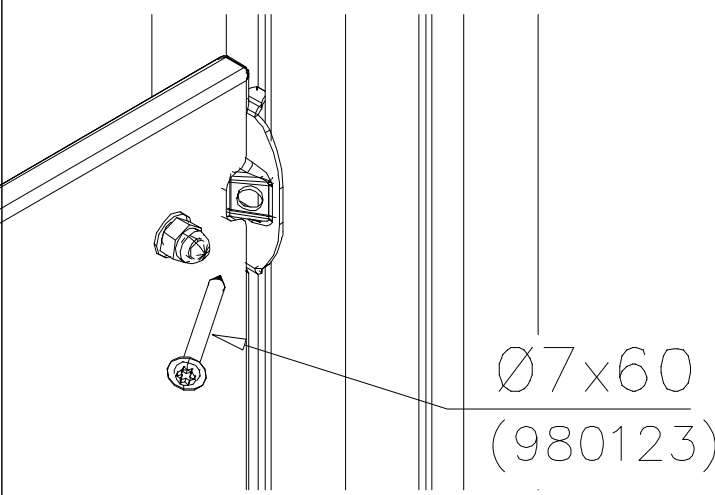
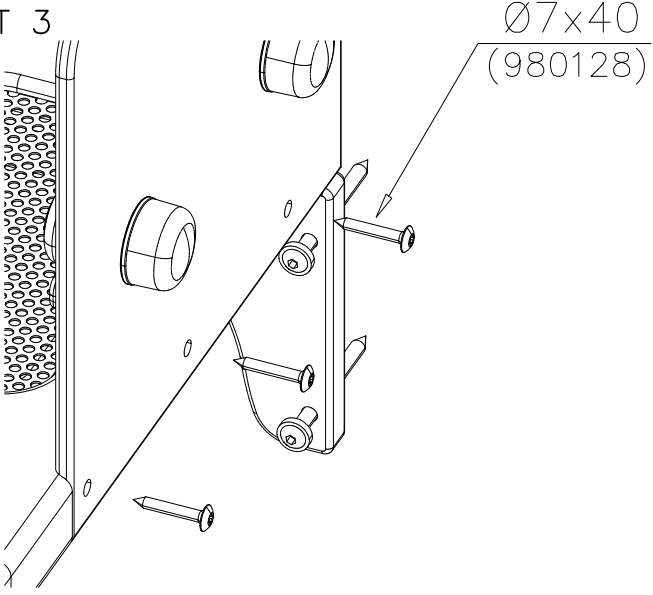
WALL OPTIONS		WALL COLOR OPTIONS	
<p>709351*</p>  <p>10x351x423</p>	<p>709372*</p>  <p>10x351x423</p>	<p>–701 BLUE</p> <p>–702 YELLOW</p> <p>–703 LIME</p> <p>–704 DARK GREY</p> <p>–705 GREY</p> <p>–706 RED</p> <p>–707 GREEN</p> <p>–708 FUCHSIA</p>	
<p>DET 1</p> 		<p>DET 2</p> 	
<p>DET 3</p> 		<p>*Note:</p> <p>Wall 709351 compatible only with table 709406</p> <p>Wall 709372 compatible only with table 709374</p>	



1. Tarkista tuoteosaluettelon ja osiin merkittyjen tuotenumeroiden avulla, että kaikki osat sisältyvät toimitukseen.
2. Valitse välineelle paikka ottaen huomioon valmistajan asennusohjeessa ilmoittamat turvaetäisyydet. Valitessasi välineen asennussuuntaa, huomioi mahdollinen altistuminen voimakkaalle auringonpaisteelle tai tuulelle. Tasoita alue ja tee ohjeen mukaiset perustustyöt. Varmista, että perustusosien alapuolinen maa on **tiivistetty riittävästi**. Tarvittaessa pohjamaa tulee vaihtaa murskeeseen tai vastaavaan kantavaan maainekseen. Iskua vaimentavan pintamateriaalin vahvuus määräytyy laskentakaavan perusteella, joka esitetään perustusohjeen lisäsivulla.
3. Välineen rungon pystystysohje esitetään sivulla 6. Yksityiskohtaiset kuvat asennuksesta on koottu erillisille ohjesivuille, joissa ne on ryhmitelty kiinnitystavan mukaan. Runkoon kiinnitettävistä komponenteista on erilliset moduuliohjeet. Noudata valmistajan asennusohjeessa ilmoittamia mitoituksia.
4. Tarkasta, että väline on suorassa ja perustukseltaan tukeva. Syväperusteisissa välineissä on suoritettava **riittävä maan tiivistäminen** kaivantojen täytön yhteydessä.
5. Tee käyttöönottotarkastus ennen välineen käyttöönottoa toimitukseen sisältyvän pöytäkirjan mukaisesti. Pöytäkirja tulee dokumentoida. Muista, että pääsy välineeseen tulee estää, kunnes se on valmis, turvallinen ja kaikki asennustarvikkeet on viety pois.

1. Kontrollera stycklistan och delarna i förpackningen med hjälp av produktnumren.
2. När du väljer platsen för utrustningen bör du beakta de säkerhetsavstånd som tillverkaren meddelat i monteringsanvisningarna. När du väljer monteringsriktning måste du beakta eventuell exponering för solsken eller vind. Jämna ut underlaget och utför grundarbetet i enlighet med instruktionerna. Säkra att marken under fundamentet är tillräckligt komprimerad. Vid behov kan man ersätta jorden med krossad sten eller motsvarande bärande jordmaterial. Styrkan på det slagdämpande ytmaterialet bestäms med hjälp av beräkningsformeln som presenteras på fundamentinstruktionernas tilläggsida.
3. Monteringsanvisningarna till utrustningens stomme finns på sidan 6. Detaljerade bilder av installationen har samlats på separata instruktionssidor, där de har grupperats enligt monteringsmetod. Det finns specifika modulanvisningar till de komponenter som ska sättas fast i stommen. Följ de dimensioner som tillverkaren gett i monteringsanvisningarna.
4. Kontrollera att utrustningen står rakt och stabilt. För utrustningar med djupt fundament måste man komprimera jorden ordentligt när man fyller igen groparna.
5. Innan utrustningen tas i bruk ska en slutbesiktning i enlighet med protokollet i leveransen utföras. Protokollet måste dokumenteras. Kom ihåg att tillträde till utrustningen måste förhindras tills den är färdig monterad, säker och alla monteringsstillbehör avlägsnats.

1. Use the parts list and the markings on the components to make sure that you have all of the necessary parts.
2. Choose a location for the product, taking into account the safety margins specified in the mounting instructions. When deciding on the orientation of the product, pay attention to potential sun and wind loads. Level the ground and prepare the foundations as instructed. Make sure that the ground underneath the foundations is solidly packed. If necessary, replace soil with wood chips or some other sturdy material. The thickness of the safety surfacing should be calculated using the formula supplied with the mounting instructions.
3. Assemble the frame of the product in accordance with the instructions on page 6. Detailed instructions for the different mounting alternatives are shown in the supplement. Separate instructions are provided for the modular components that will be attached to the frame. Please follow the stated measurements carefully.
4. Make sure that the product is mounted straight and firmly into the ground. Remember to pack the soil carefully when refilling the excavation around deep-mounted structures.
5. Inspect the installation thoroughly using the checklist provided. Document the completed checklist carefully. Remember to stop children from using the product until it has been fully built and safety-tested and all mounting equipment has been cleared away.

1. Überprüfen Sie die Lieferung auf Vollständigkeit, indem Sie das Teileverzeichnis mit der Lieferung abgleichen.
2. Wählen Sie einen Standort für das Gerät und berücksichtigen Sie die vom Hersteller in der Installationsanleitung genannten Sicherheitsabstände. Bei der Ausrichtung des Gerätes beachten Sie den möglichen Einfluss von starker Sonneneinstrahlung oder Wind. Ebenen Sie den Bereich und führen Sie die Fundamentarbeiten nach der Anleitung durch. Stellen Sie sicher, dass der Boden unter den Fundamentteilen ausreichend verdichtet ist. Wenn nötig, muss das Untergrundmaterial durch Split oder ein anderes tragfähiges Material ausgetauscht werden. Die Stärke des stoßdämpfenden Oberflächenmaterials wird auf Grundlage einer Formel berechnet, die im Anhang der Anleitung für die Fundamente dargestellt ist.
3. Die Aufbauanleitung für den Rahmen des Gerätes finden Sie auf Seite 6. Detaillierte Bilder der Installation sind auf gesonderten Anleitungsseiten zusammengestellt, auf denen sie nach ihrer Befestigungsweise geordnet sind. Für die am Geräterahmen befestigten Komponenten gibt es besondere Modulanleitungen. Halten Sie die in der Installationsanleitung vom Hersteller genannten Maße ein.
4. Überprüfen Sie, dass das Gerät in Waage steht und sicher am Boden verankert ist. Bei Geräten mit Tiefenfundamenten muss der Boden beim Auffüllen des Aushubs ausreichend verdichtet oder betoniert werden.
5. Führen Sie eine Inbetriebnahmeüberprüfung entsprechend des im Lieferumfang enthaltenen Protokolls durch, bevor das Gerät benutzt wird. Das Protokoll muss aktenkundig dokumentiert werden. Denken Sie daran, dass der Zugang zum Gerät verhindert werden muss, bis es fertig und sicher ist und alle Installationswerkzeuge entfernt sind.

1. Vérifier à l'aide de la liste des pièces et des numéros de produit marqués sur les pièces que la livraison comprend toutes les pièces nécessaires.
2. Choisir un bon emplacement pour l'équipement, compte tenu des distances de sécurité indiquées par le fabricant dans les instructions de montage. Tenir compte de l'exposition éventuelle aux forts rayons de soleil ou au vent lors du choix du sens de montage de l'équipement. Egaliser la surface de l'emplacement choisi et effectuer les travaux de fondation conformément aux instructions. S'assurer que le sol sous les pièces de fondation a été suffisamment compacté. Si besoin est, le sol de fondation doit être remplacé par des pierres concassées ou un matériau portant similaire. L'épaisseur du matériau de surface anti-choc est calculée selon la formule indiquée à la page supplémentaire des instructions de fondation.
3. Les instructions d'érection de l'ossature de l'équipement sont indiquées à la page 6. Les images détaillées du montage sont adjointes aux pages d'instruction séparées où elles sont groupées selon le mode de fixation. Des instructions modulaires séparées sont données pour les composants à fixer sur l'ossature. Respecter les mesures données par le fabricant dans les instructions de montage.
4. Vérifier que l'équipement est droit et que sa fondation est solide. Dans le cas des équipements dont la fondation se trouve sous le sol, le sol doit être suffisamment compacté lors du remplissage des trous.
5. Effectuer un contrôle de mise en service conforme au procès-verbal compris dans la livraison avant la mise en service de l'équipement. Ce procès-verbal doit être documenté. Ne pas oublier d'empêcher l'accès à l'équipement jusqu'à ce que celui-ci soit prêt et sûr et que tous les outils de montage aient été enlevés.

												
<p><b><math>h &lt; 600</math></b></p> <p>Without movement and therefore without Impact Area</p>	<p>Totally hard surfaces.</p> <p>Note. Lappset does <u>not recommend</u> totally hard surfaces at all.</p>	<p>E.g. concrete or asphalt</p> 										
<p><b><math>h &lt; 600</math></b></p> <p>With movement e.g. rocking</p>	<p>Materials with very limited impact attenuating properties.</p>	<p>E.g. wood</p> 										
<p><b><math>h &lt; 1000</math></b></p>	<p>Materials with significant impact attenuating properties.</p>	<p>fine gravel 0–8 mm</p>  <p>grass</p>  <p>unsorted sand</p> 										
<p><b><math>h &lt; 3000</math></b></p>	<p>Loose fill material</p> <p>E.g. sand/gravel 0,25...8 mm D60/D10&lt;3,0 Woodchips 5...30 mm bark 20...80 mm</p>	 <table data-bbox="1021 1691 1332 1792"> <tr> <td><math>\underline{S}</math></td> <td><math>\underline{h}</math></td> </tr> <tr> <td>30 cm</td> <td>&lt; 2,0 m</td> </tr> <tr> <td>40 cm</td> <td>&lt; 3,0 m</td> </tr> </table>	$\underline{S}$	$\underline{h}$	30 cm	< 2,0 m	40 cm	< 3,0 m				
$\underline{S}$	$\underline{h}$											
30 cm	< 2,0 m											
40 cm	< 3,0 m											
	<p>Syntethic granulates</p> <table data-bbox="406 1892 758 2060"> <tr> <td><math>\underline{S}</math></td> <td><math>\underline{h}</math></td> </tr> <tr> <td>40 mm</td> <td>~&gt; 1,2...1,3 m</td> </tr> <tr> <td>50 mm</td> <td>~&gt; 1,5...1,7 m</td> </tr> <tr> <td>60 mm</td> <td>~&gt; 1,8...2,0 m</td> </tr> <tr> <td>70 mm</td> <td>~&gt; 2,1...2,5 m</td> </tr> </table> <p>Note. For accurate values, see manufacturer's instructions.</p>	$\underline{S}$	$\underline{h}$	40 mm	~> 1,2...1,3 m	50 mm	~> 1,5...1,7 m	60 mm	~> 1,8...2,0 m	70 mm	~> 2,1...2,5 m	
$\underline{S}$	$\underline{h}$											
40 mm	~> 1,2...1,3 m											
50 mm	~> 1,5...1,7 m											
60 mm	~> 1,8...2,0 m											
70 mm	~> 2,1...2,5 m											

REMOVE SAFETY SURFACE/SAND/GRAVEL  
TO CHECK FOUNDATION

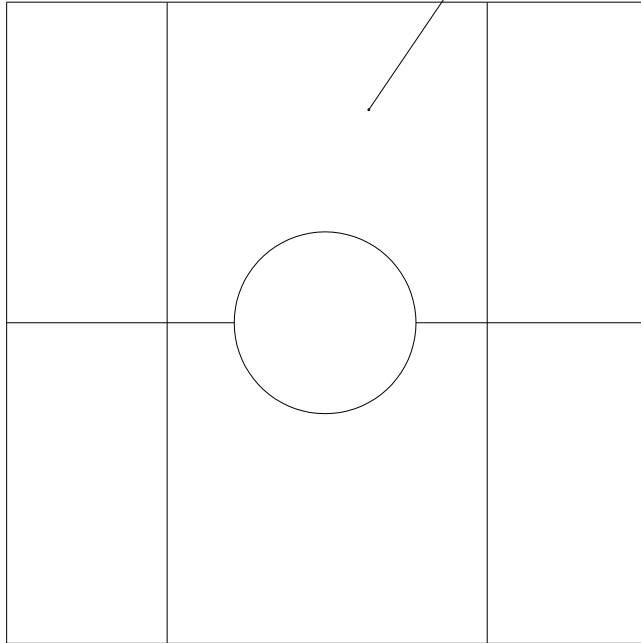

REMOVE SAFETY SURFACE/SAND/GRAVEL  
TO CHECK FOUNDATION

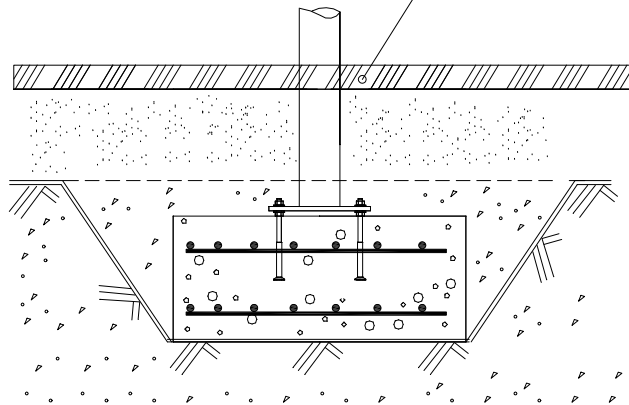

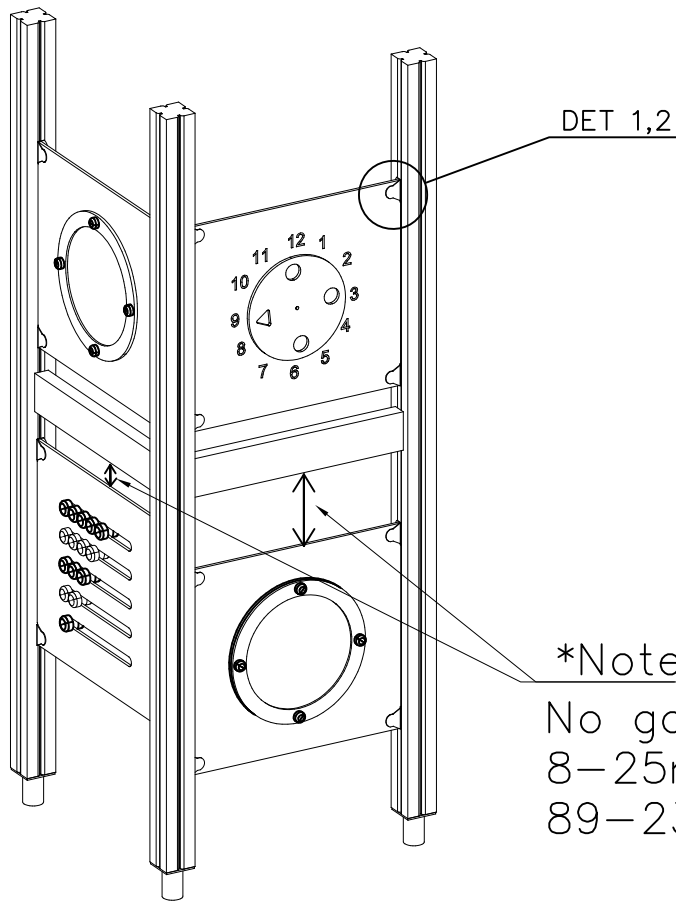

① 903176	PCS	② 909850	PCS
	4		4
		M8x25	
③ 909256	PCS	④ 909633	PCS
	8		4
Ø16/8.4x1.6		M8	
⑤ 980123	PCS		PCS
	4		
Ø7x60			

\*Note:

No gaps between:  
8–25mm  
89–230mm

### COLOR OPTIONS

- 701 BLUE
- 702 YELLOW
- 703 LIME
- 704 DARK GRAY
- 705 LIGHT GRAY
- 706 RED
- 707 GREEN
- 708 FUXIA

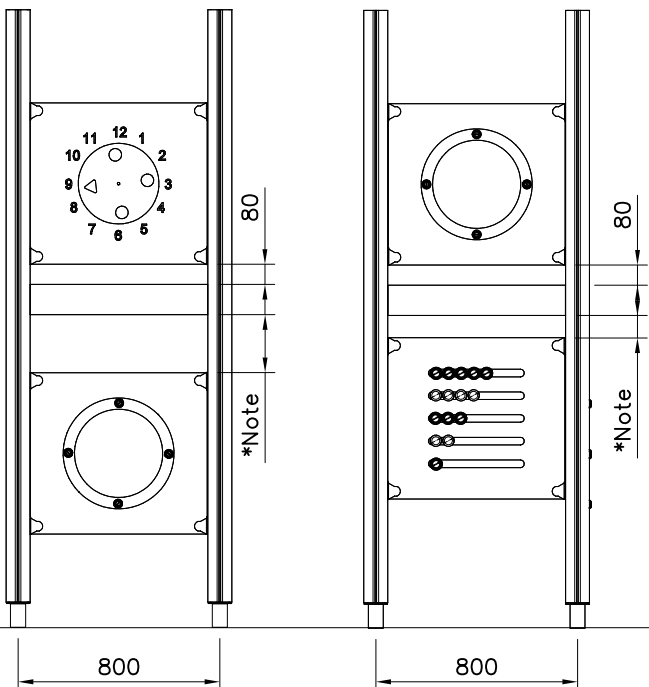



GAME WALL OPTIONS

706766	706772	706308	707453
			
640x702	640x702	640x702	640x702
707209	705705	707433	707386
			
640x702	640x702	640x702	640x702
709403	709358	709405	
			
640x702	640x702	420x702	

DET 1



DET 2



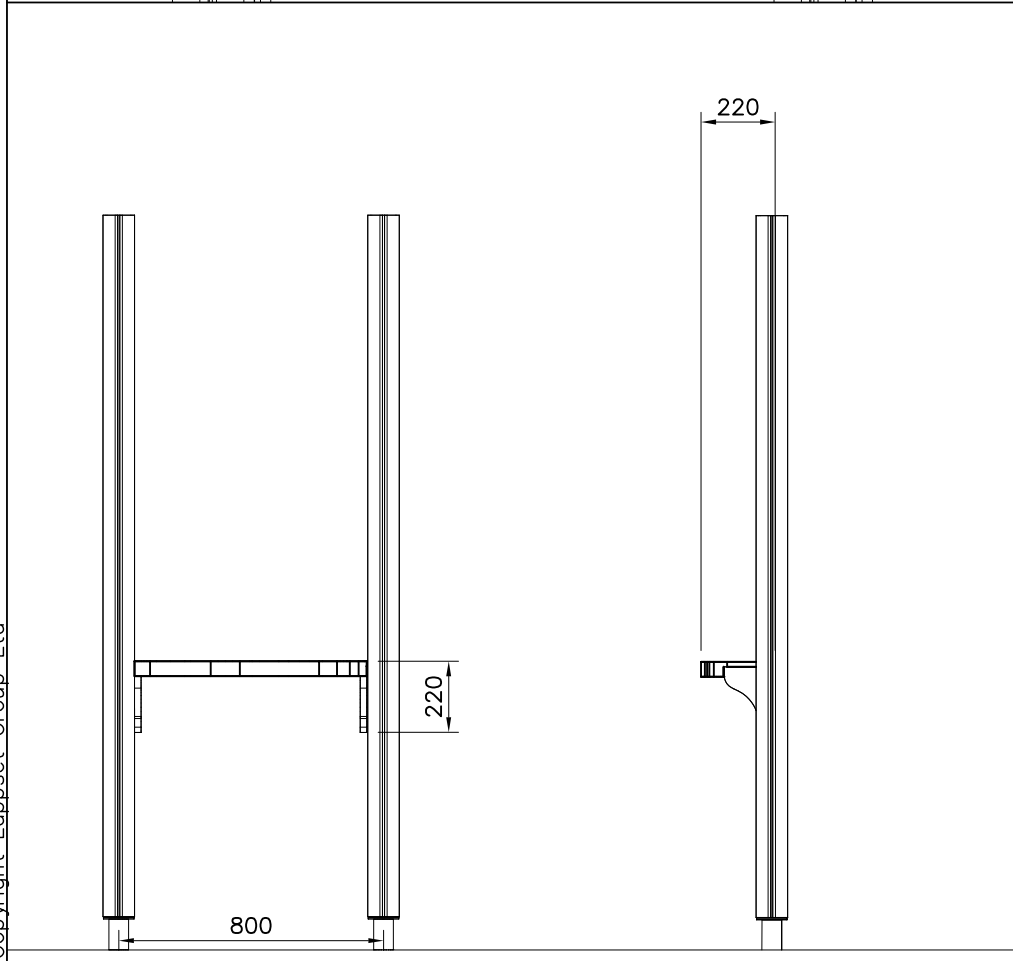
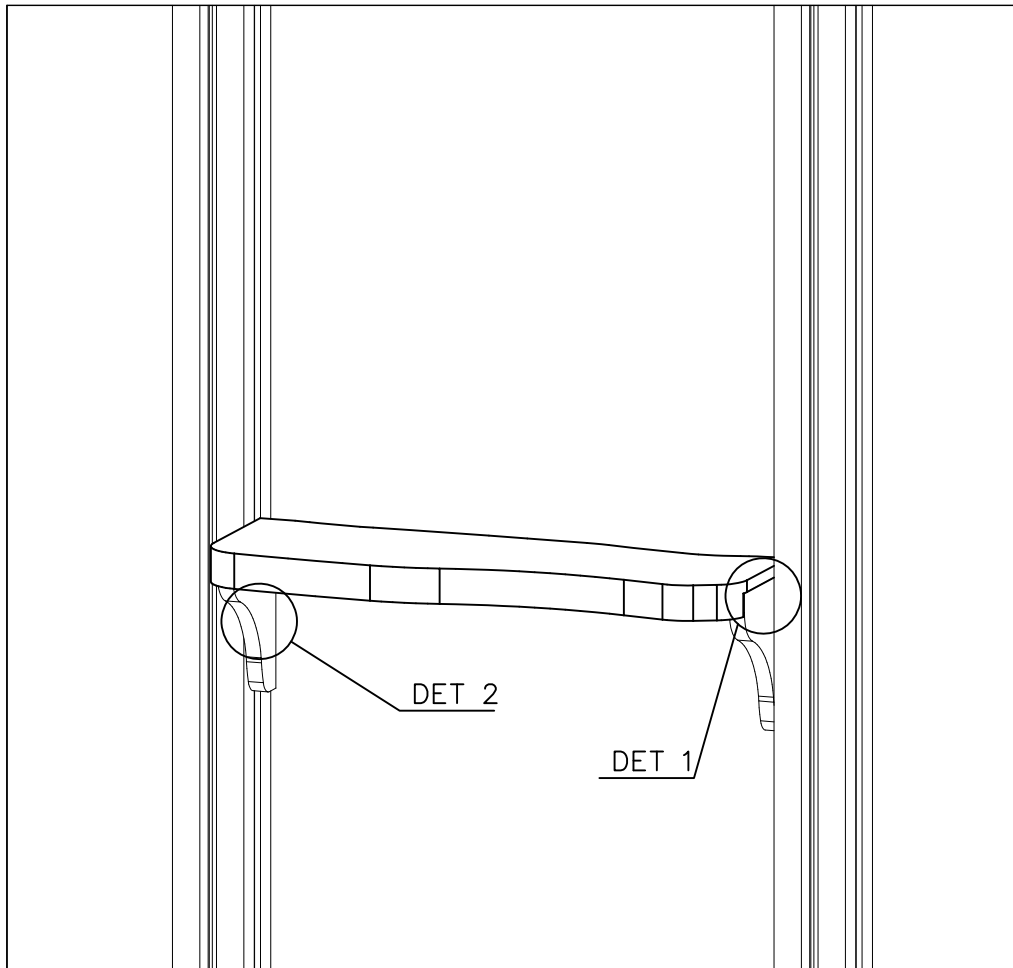



① 980128	PCS	② 903093	PCS
	4		6
Ø7x40		Ø8x90	
	PCS		PCS
	PCS		PCS
	PCS		PCS
	PCS		PCS
	PCS		PCS
○ 709350	PCS	○ 709400	PCS
	1		1
20x154x200		20x154x200	

TABLE OPTIONS

709375

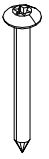

45x224x702

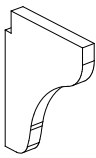
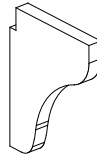
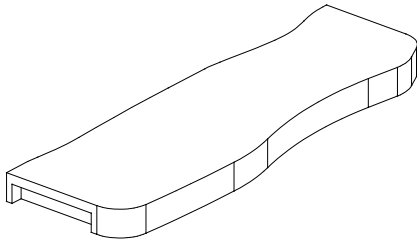
709374\*

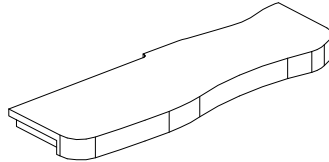

45x224x702

709406\*

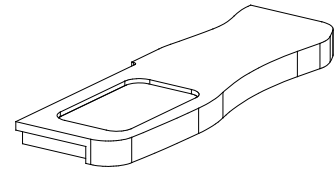

45x224x702

DET 1

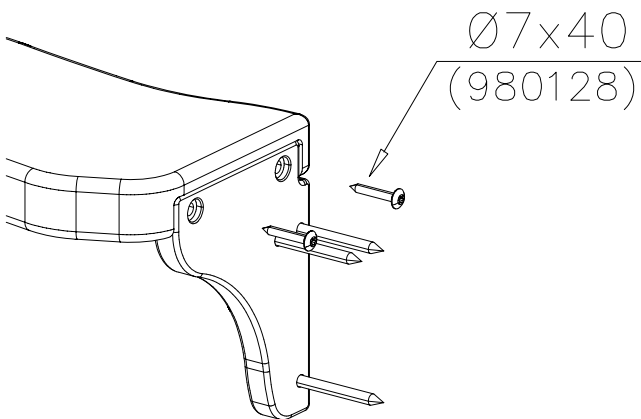

DET 2

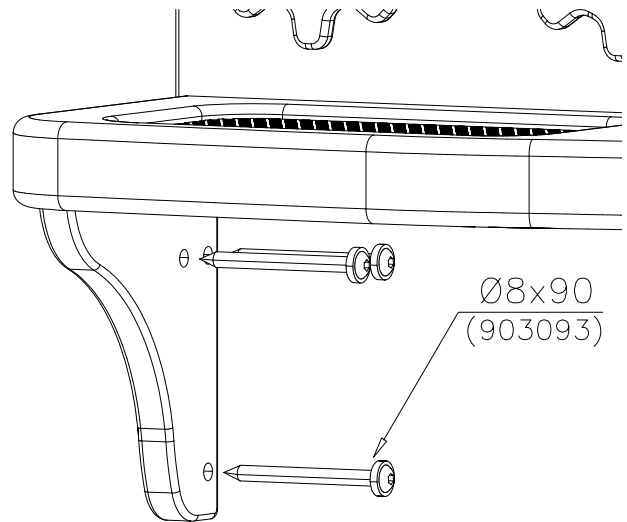

\*Note:

Table 709406 compatible only with wall 709351

Table 709374 compatible only with wall 709372



**Tuotekyltti tulee tuotteen mukana yhdellä seuraavista tavoista:**

**1) Metallinen tuotekyltti ja kiinnitysruuvit**

- Kiinnitä tuotekyltti ruuveilla tolppaan noin 2 metrin korkeuteen kuvan 1 mukaisesti.

**2) Tuotekylttitarra**

- Puhdista maalattu metalli- tai vaneripinta pölystä ja kosteudesta. Liimaa tarra kuvan 2 mukaisesti.
- Huom. Älä kiinnitä tarraa karheapintaiseen laminaattiin tai maalattuun puuhun.

**Vår produktmärkning levereras på ett av följande sätt:**

**1) Produktskylt i metall**

- Fäst skylten med de medföljande skruvarna

**2) Självhäftande produktetikett**

- Rengör den pulverlackerade metallytan eller laminatyten så att den blir fri från smuts och fukt. Fäst etiketten enligt fig. 2.
- Obs! Fäst ej etiketten på detaljer med skrovlig yta eller på målat trä.

**Product label is delivered by one of following ways:**

**1) Metal product label and screws**

- Fasten the label with screws.

**2) Label sticker**

- Clean the painted metal or plywood surface from dirt and moisture. Fasten the sticker as shown in the figure 2.
- Note. Do not attach the sticker to rough surfaced laminate or painted wood.

**La plaque d'informations produit est livrée sous l'une de ces 3 formes :**

**1) Plaque métallique et vis**

- Fixez la plaque à l'aide des vis.

**2) Etiquette autocollante**

- Avant de coller l'étiquette, nettoyez le composant métallique peint ou la plaque de contreplaqué, de toute saleté. La surface doit être sèche (voir image 2).
- Attention, ne pas coller l'étiquette sur une surface lamellé-collée irrégulière ou sur du bois peint.

**Die Auslieferung des Produktaufklebers erfolgt auf eine dieser Arten:**



**1) Produkt-Schild aus Metall incl. Schrauben**

- Die Befestigung des Schildes erfolgt mittels der Schrauben.

**2) Aufkleber**

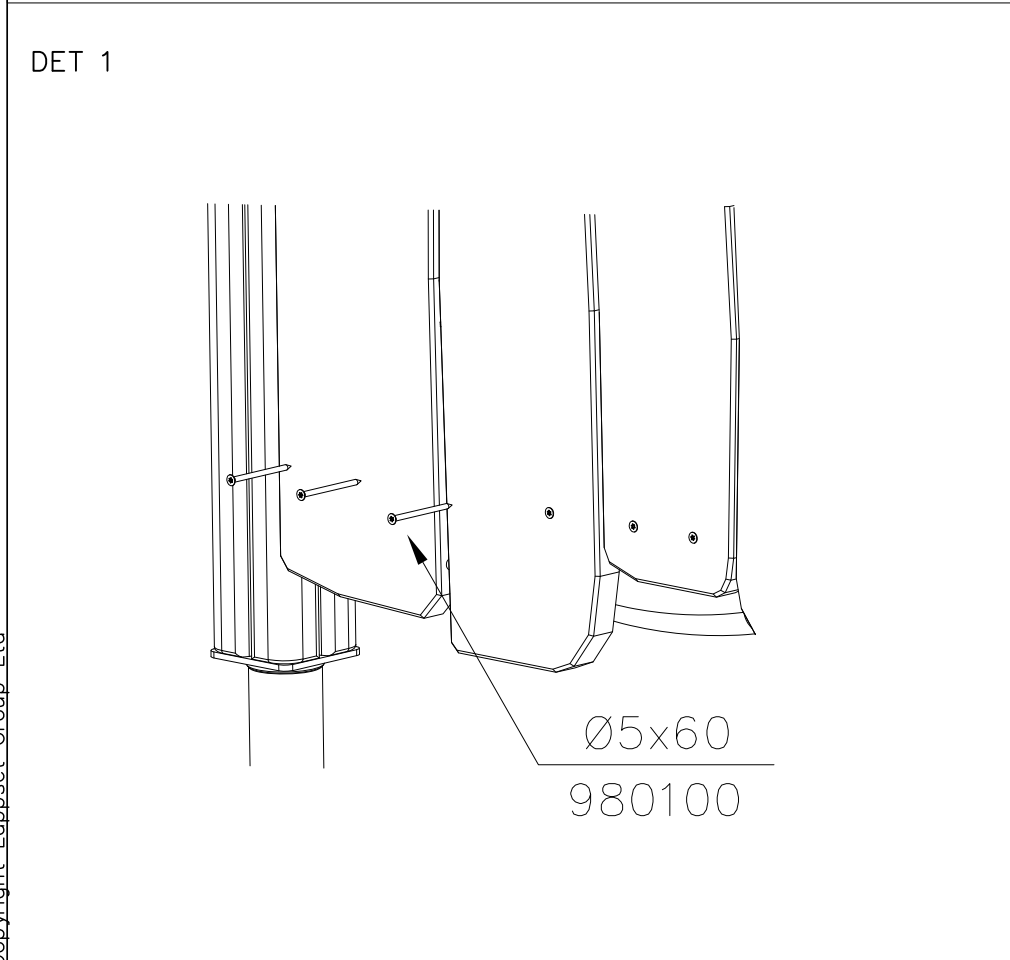
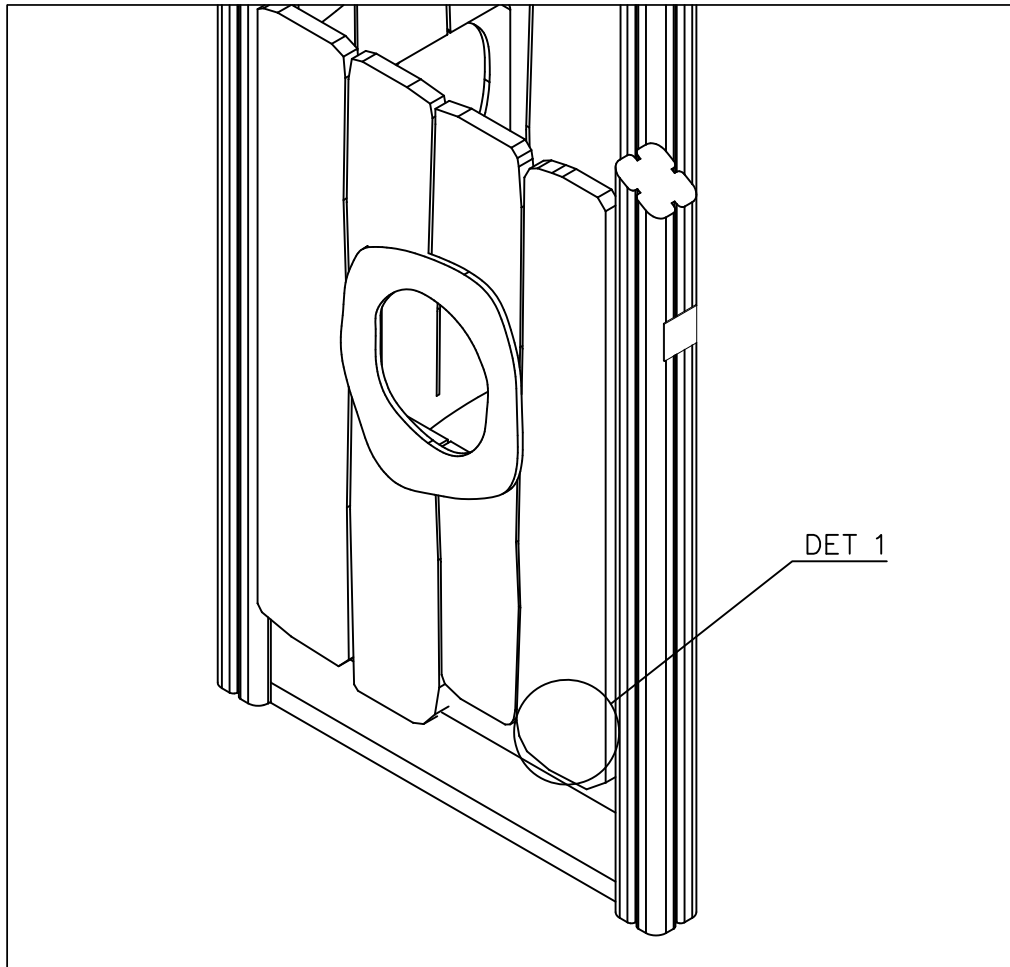
- Entfernen Sie zunächst Schmutz und Feuchtigkeit vom lackierten Metall bzw. von der Holzoberfläche und bringen Sie den Aufkleber wie im Bild oben rechts beschrieben auf den gesäuberten Untergrund auf.
- Beachten Sie: Bringen Sie den Aufkleber nicht auf raues laminiertes oder lackiertes Holz an.

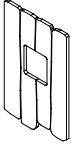

① 708595	PCS	② 980100	PCS
	1		16
700x1100		Ø5x60	
	PCS		PCS
	PCS		PCS
	PCS		PCS
	PCS		PCS
	PCS		PCS
	PCS		PCS
	PCS		PCS