

# **LAPPSET®**

## **FINNO**











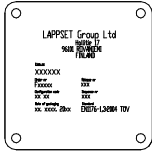

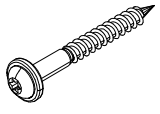
ASENNUSOHJE  
MONTERINGSANSVISNING  
INSTALLATION INSTRUCTION  
AUFBAUANLEITUNG  
NOTICE D'INSTALLATION

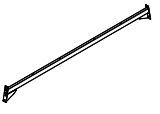
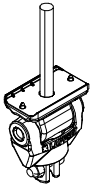
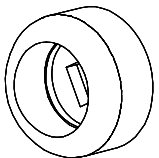
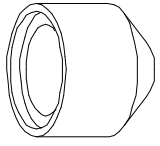
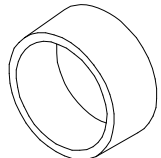
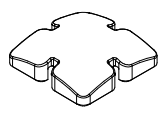
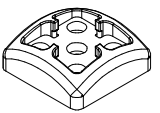
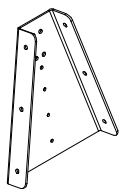
DATE: 5.7.2022

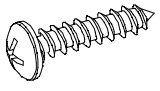
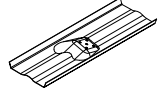
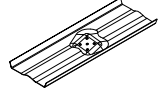
### **Q15985**

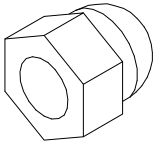
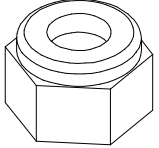
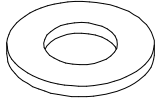
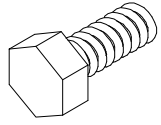
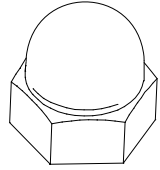

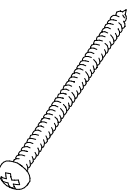
DATE: 24.5.2022

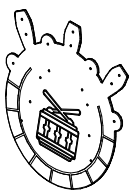
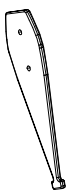
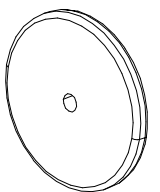
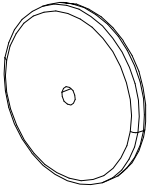
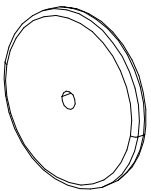
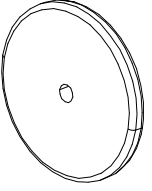
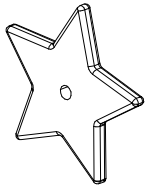
702286  65x65	PCS 1	706562  L2250	PCS 4	900240  Ø8x70	PCS 8	900965  M10	PCS 4	903149  M12x30	PCS 4	904333  L2940	PCS 1
904904 	PCS 4	905090  Ø45	PCS 12	905104  M10	PCS 16	905115  Ø30	PCS 12	905138 	PCS 4	905196 	PCS 4
905991 	PCS 2	909347  M12x35	PCS 12	909506  Ø3.5x13	PCS 4	909507  L 1000	PCS 2	909508  L 1000	PCS 2	909511  L650	PCS 4
909633  M8	PCS 28	909637  M10	PCS 16	909638  Ø20/10.5	PCS 40	909639  M10x25	PCS 20	909644  M12	PCS 4	909852  M8x30	PCS 28
980131  Ø6x60	PCS 16	980154  Ø24x13	PCS 20	999561  10g	PCS 1	P16396 	PCS 2	P16397 	PCS 6	P16398-701 	PCS 2
P16398-702 	PCS 2	P16398-706 	PCS 2	P16398-708 	PCS 2	P16399 	PCS 8		PCS		PCS
	PCS		PCS		PCS		PCS		PCS		PCS

EN/AS Impact Area 21.9 m<sup>2</sup>

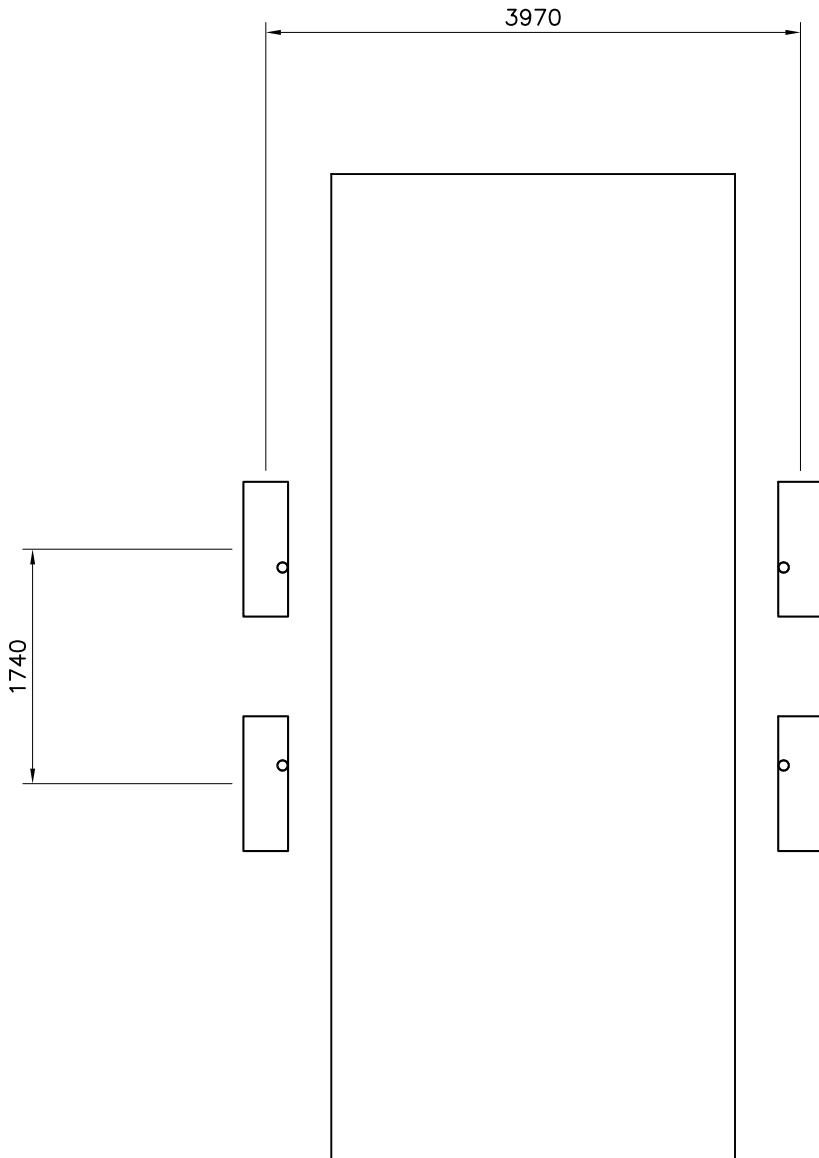

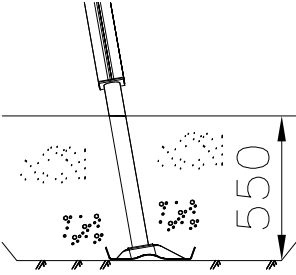
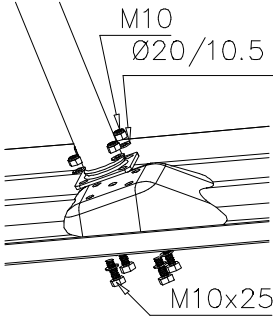
 <p>550</p>	 <p>M10 Ø20/10.5 M10x25</p>	

- EN/AS Impact Area 21.9 m<sup>2</sup>
- Falling Space 21.9 m<sup>2</sup>
- Max Falling Height 1200 mm

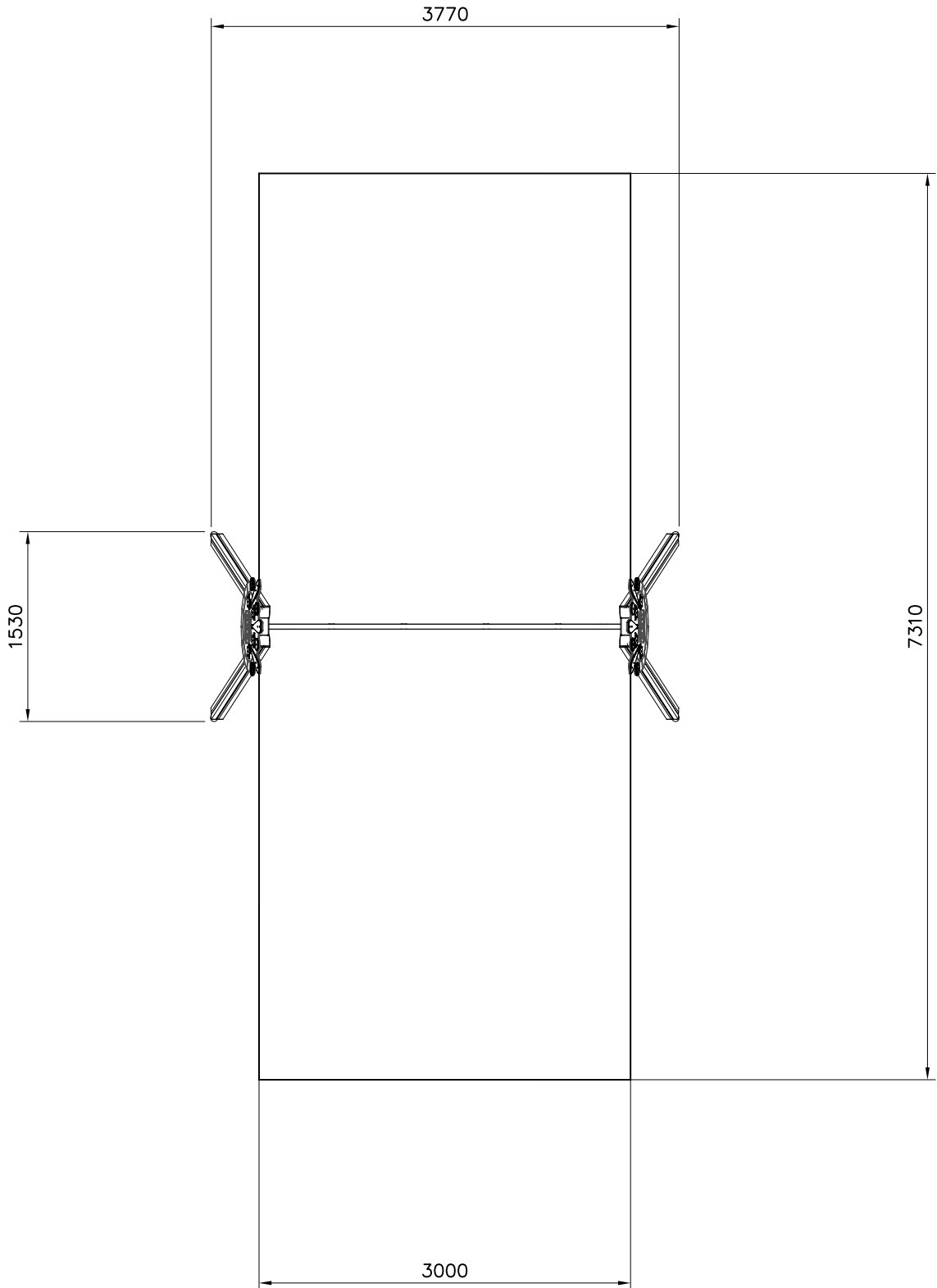

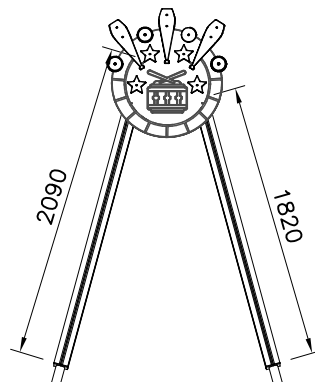
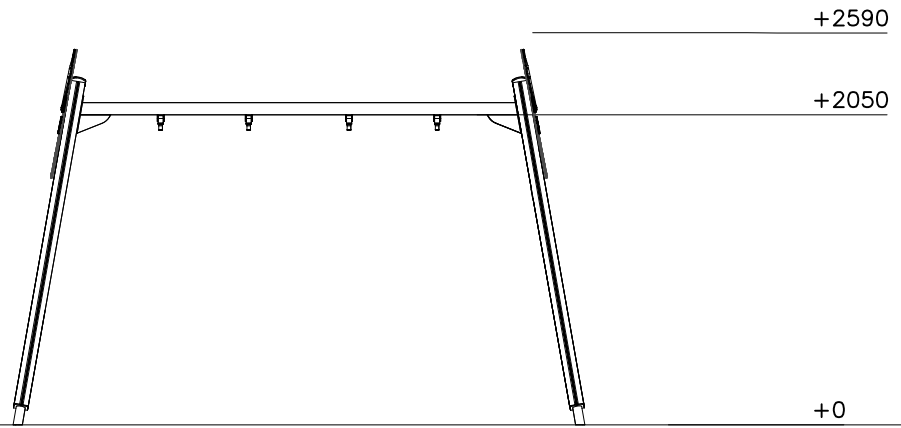

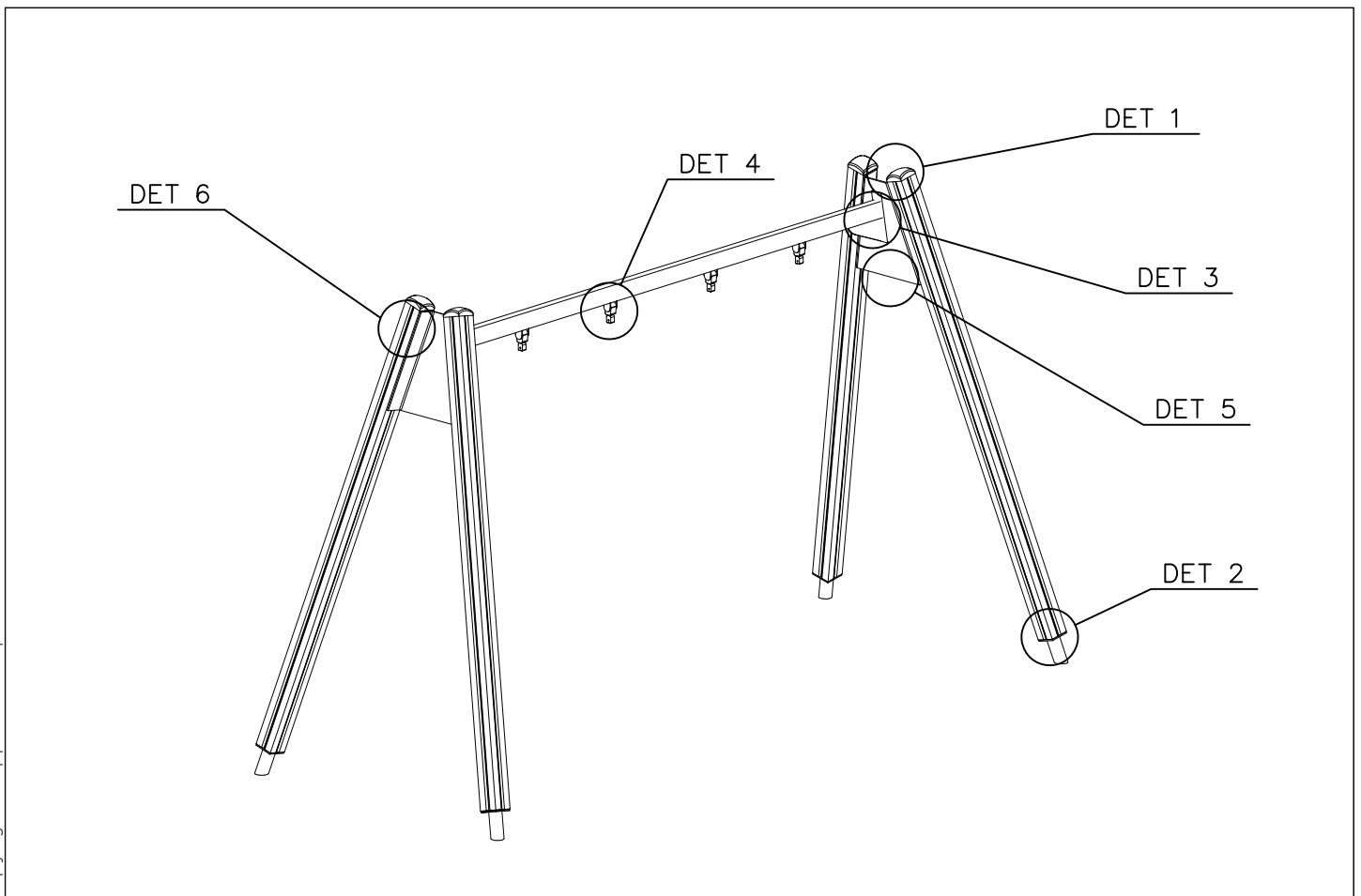
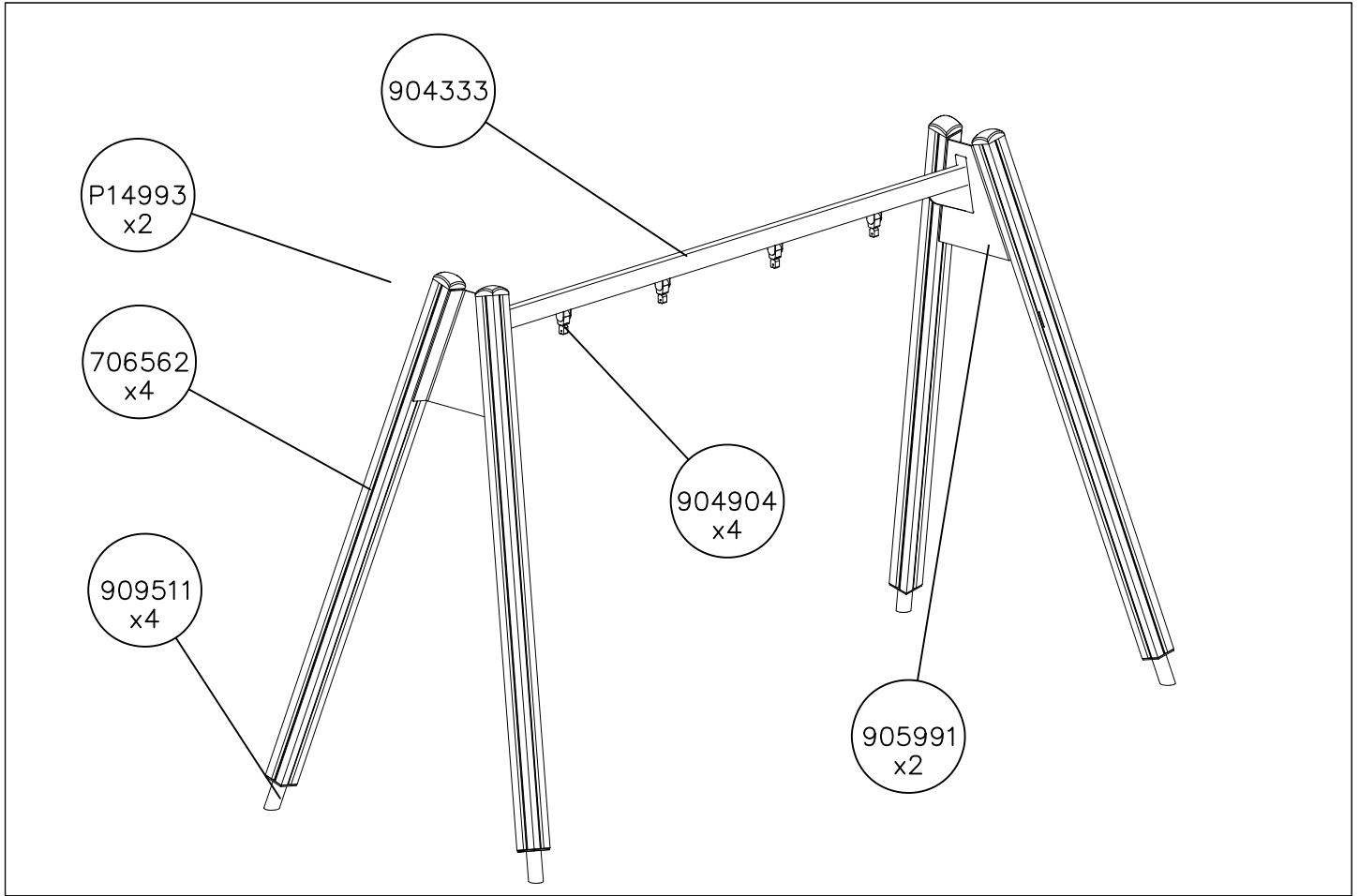

<p>DET 1</p> <p>6x60 980131</p>	<p>DET 2</p> <p>M10 905104 909521</p>	<p>DET 3</p> <p>M12 → 80 Nm M12 M12x30 M10x25 M10 → 45 Nm Ø24/13 Ø20/10.5</p>	<p>DET 4</p> <p>M12 980154 Ø24/13 904904</p>
<p>DET 5</p> <p>999561 GLUE Ø24/13 12x35 905115 905090</p>	<p>DET 6</p> <p>Ø8x70</p>		

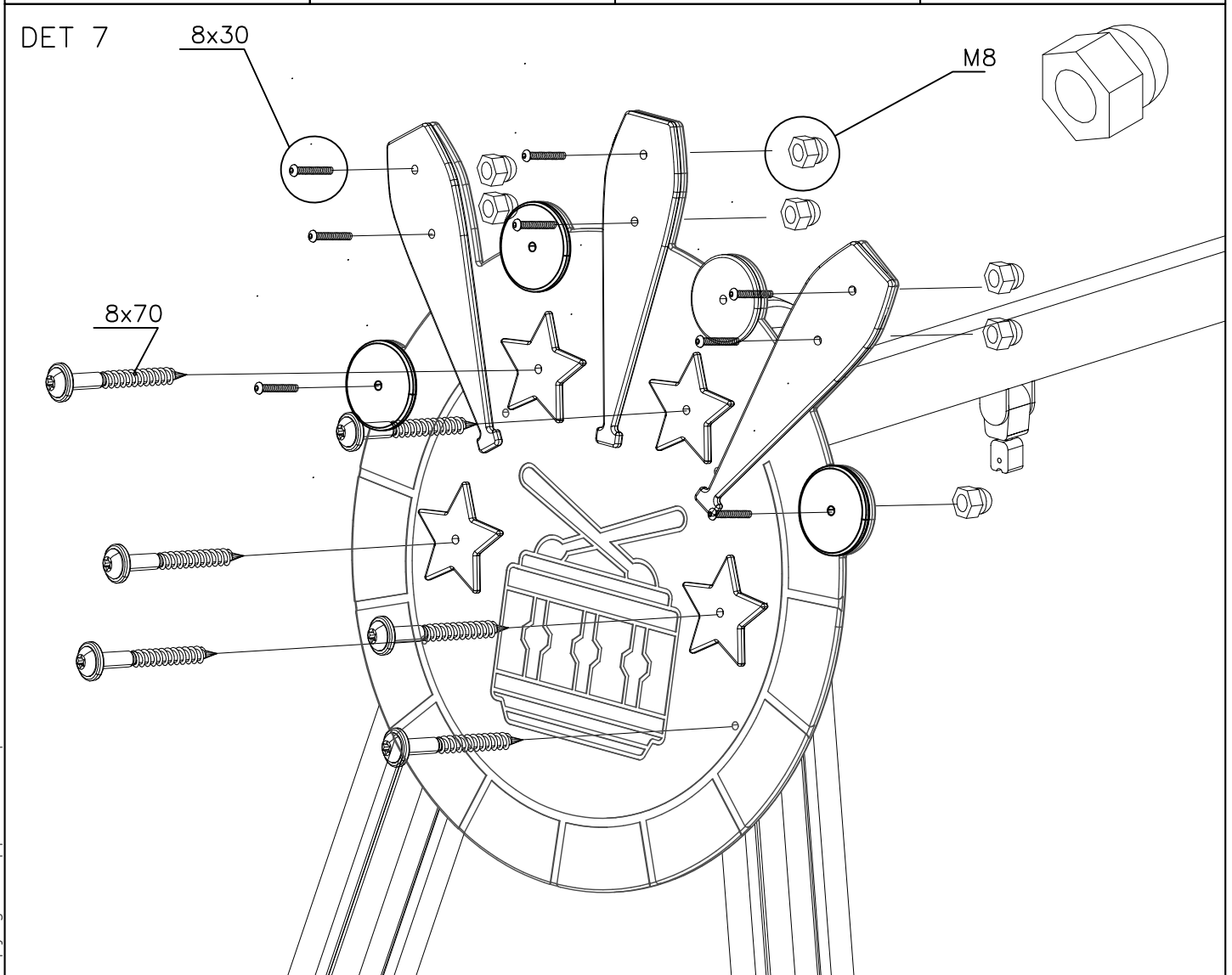



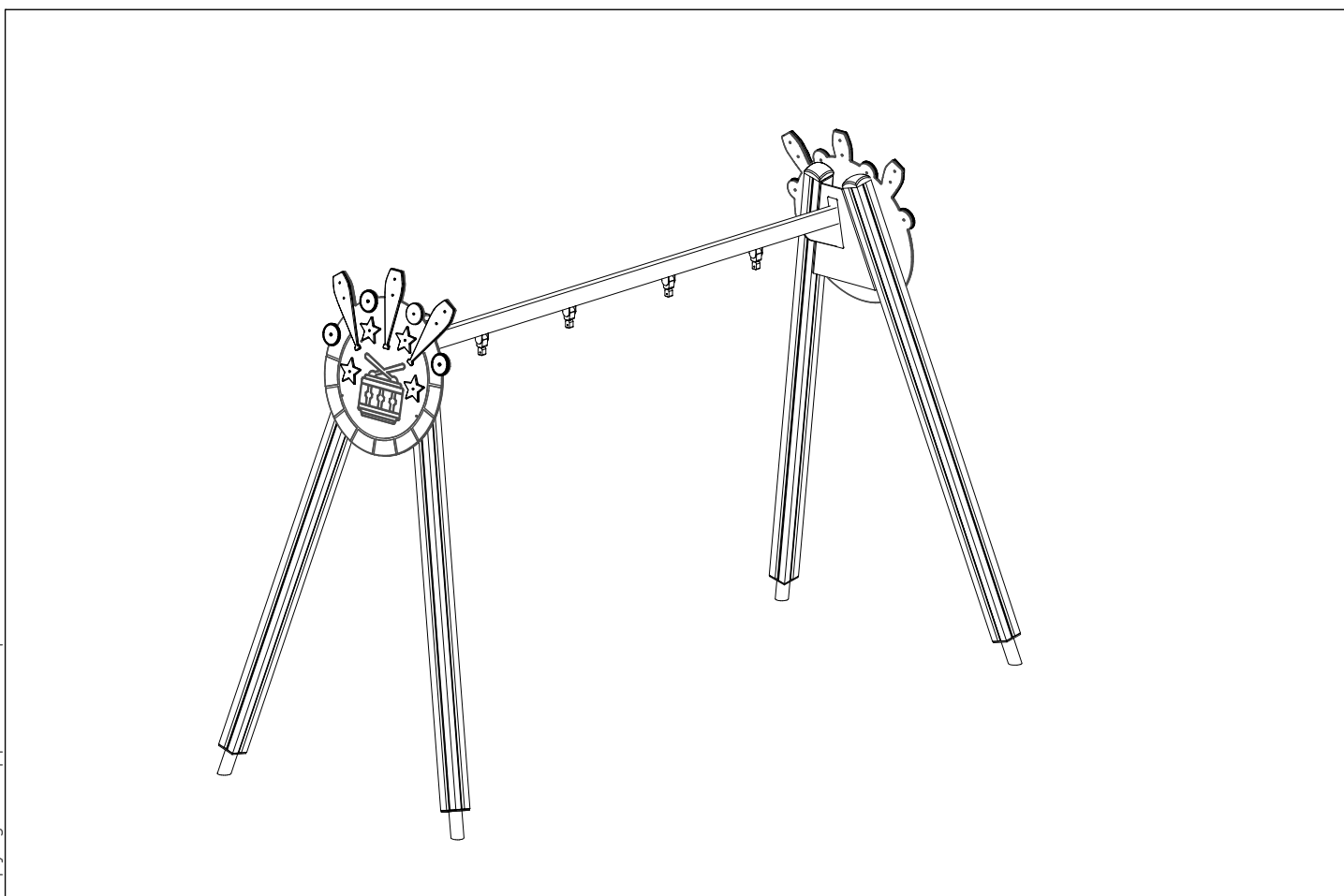
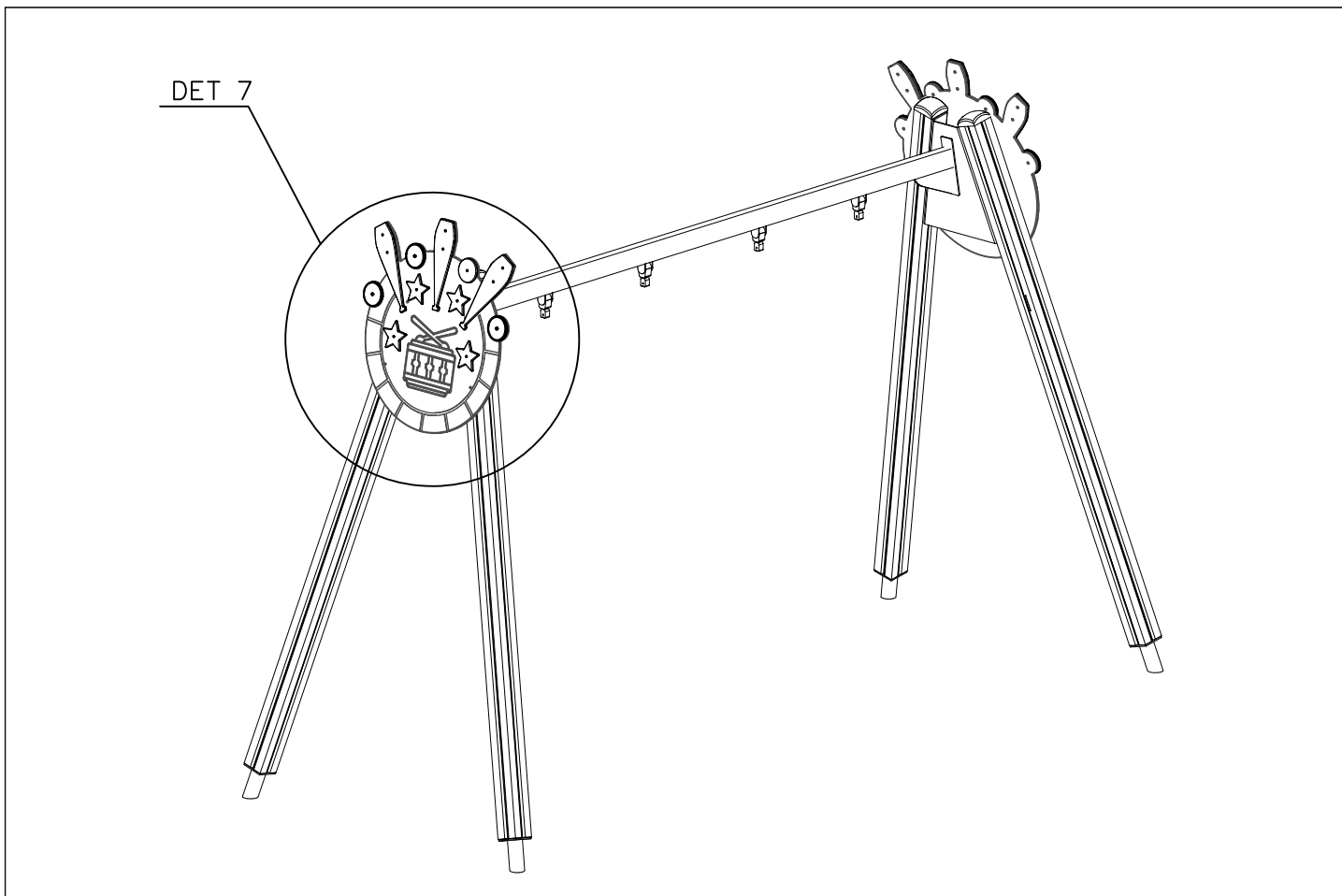

												
<p><b><math>h &lt; 600</math></b></p> <p>Without movement and therefore without Impact Area</p>	<p>Totally hard surfaces.</p> <p>Note. Lappset does <u>not recommend</u> totally hard surfaces at all.</p>	<p>E.g. concrete or asphalt</p> 										
<p><b><math>h &lt; 600</math></b></p> <p>With movement e.g. rocking</p>	<p>Materials with very limited impact attenuating properties.</p>	<p>E.g. wood</p> 										
<p><b><math>h &lt; 1000</math></b></p>	<p>Materials with significant impact attenuating properties.</p>	<p>fine gravel 0–8 mm</p>  <p>grass</p>  <p>unsorted sand</p> 										
<p><b><math>h &lt; 3000</math></b></p>	<p>Loose fill material</p> <p>E.g. sand/gravel 0,25...8 mm D60/D10&lt;3,0 Woodchips 5...30 mm bark 20...80 mm</p>	 <table data-bbox="1021 1691 1332 1792"> <tr> <td><math>\underline{S}</math></td> <td><math>\underline{h}</math></td> </tr> <tr> <td>30 cm</td> <td>&lt; 2,0 m</td> </tr> <tr> <td>40 cm</td> <td>&lt; 3,0 m</td> </tr> </table>	$\underline{S}$	$\underline{h}$	30 cm	< 2,0 m	40 cm	< 3,0 m				
$\underline{S}$	$\underline{h}$											
30 cm	< 2,0 m											
40 cm	< 3,0 m											
	<p>Syntethic granulates</p> <table data-bbox="406 1892 758 2060"> <tr> <td><math>\underline{S}</math></td> <td><math>\underline{h}</math></td> </tr> <tr> <td>40 mm</td> <td>~&gt; 1,2...1,3 m</td> </tr> <tr> <td>50 mm</td> <td>~&gt; 1,5...1,7 m</td> </tr> <tr> <td>60 mm</td> <td>~&gt; 1,8...2,0 m</td> </tr> <tr> <td>70 mm</td> <td>~&gt; 2,1...2,5 m</td> </tr> </table> <p>Note. For accurate values, see manufacturer's instructions.</p>	$\underline{S}$	$\underline{h}$	40 mm	~> 1,2...1,3 m	50 mm	~> 1,5...1,7 m	60 mm	~> 1,8...2,0 m	70 mm	~> 2,1...2,5 m	
$\underline{S}$	$\underline{h}$											
40 mm	~> 1,2...1,3 m											
50 mm	~> 1,5...1,7 m											
60 mm	~> 1,8...2,0 m											
70 mm	~> 2,1...2,5 m											

REMOVE SAFETY SURFACE/SAND/GRAVEL  
TO CHECK FOUNDATION



REMOVE SAFETY SURFACE/SAND/GRAVEL  
TO CHECK FOUNDATION



**LAPPSET®**  
**BETON FOUNDATION**

**FOOT**

DATE: 27.10.2015

**1(1)**

② 905104	PCS		PCS
	4		
 M10	PCS		PCS



905104

**Tuotekyltti tulee tuotteen mukana yhdellä seuraavista tavoista:****1) Metallinen tuotekyltti ja kiinnitysruuvit**

- Kiinnitä tuotekyltti ruuveilla tolppaan noin 2 metrin korkeuteen kuvan 1 mukaisesti.

**2) Tuotekylttitarra**

- Puhdista maalattu metalli- tai vaneripinta pölystä ja kosteudesta. Liimaa tarra kuvan 2 mukaisesti.
- Huom. Älä kiinnitä tarraa karheapintaiseen laminaattiin tai maalattuun puuhun.

**Vår produktmärkning levereras på ett av följande sätt:****1) Produktskylt i metall**

- Fäst skylten med de medföljande skruvarna

**2) Självhäftande produktetikett**

- Rengör den pulverlackerade metallytan eller laminatyten så att den blir fri från smuts och fukt. Fäst etiketten enligt fig. 2.
- Obs! Fäst ej etiketten på detaljer med skrovlig yta eller på målat trä.

**Product label is delivered by one of following ways:****1) Metal product label and screws**

- Fasten the label with screws.

**2) Label sticker**

- Clean the painted metal or plywood surface from dirt and moisture. Fasten the sticker as shown in the figure 2.
- Note. Do not attach the sticker to rough surfaced laminate or painted wood.

**La plaque d'informations produit est livrée sous l'une de ces 3 formes :****1) Plaque métallique et vis**

- Fixez la plaque à l'aide des vis.

**2) Etiquette autocollante**

- Avant de coller l'étiquette, nettoyez le composant métallique peint ou la plaque de contreplaqué, de toute saleté. La surface doit être sèche (voir image 2).
- Attention, ne pas coller l'étiquette sur une surface lamellé-collée irrégulière ou sur du bois peint.

**Die Auslieferung des Produktaufklebers erfolgt auf eine dieser Arten:****1) Produkt-Schild aus Metall incl. Schrauben**

- Die Befestigung des Schildes erfolgt mittels der Schrauben.

**2) Aufkleber**

- Entfernen Sie zunächst Schmutz und Feuchtigkeit vom lackierten Metall bzw. von der Holzoberfläche und bringen Sie den Aufkleber wie im Bild oben rechts beschrieben auf den gesäuberten Untergrund auf.
- Beachten Sie: Bringen Sie den Aufkleber nicht auf raues laminiertes oder lackiertes Holz an.