

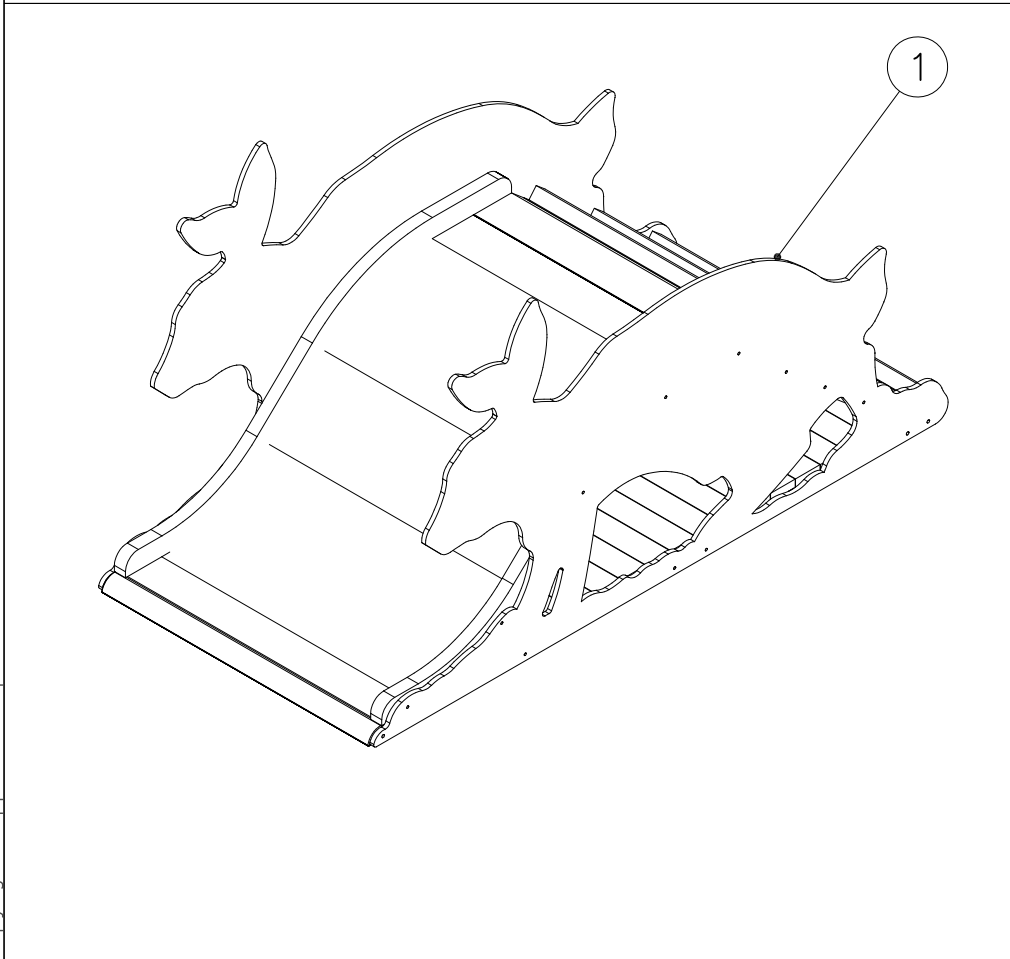
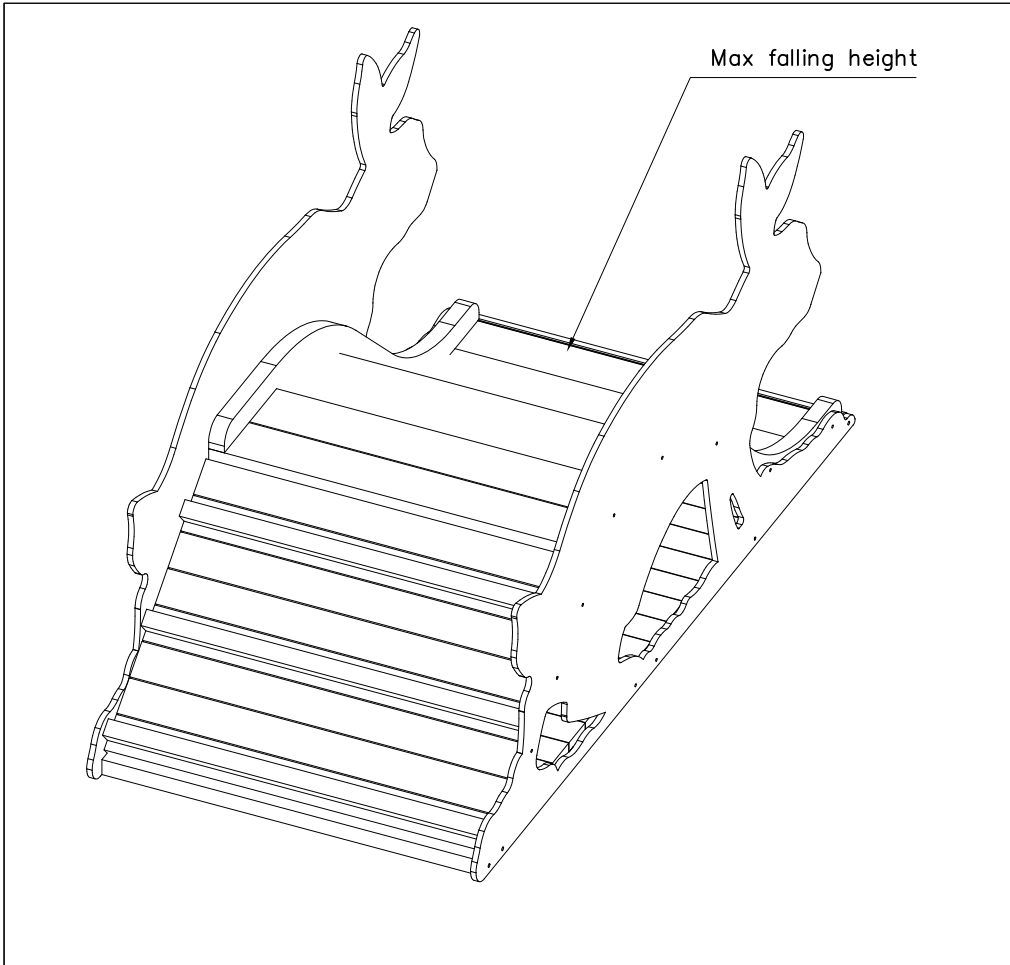

# LAPPSET® SOLITAIRE

# Q05354-1

DATE: 9.3.2022

1(2)

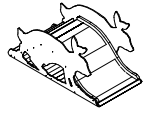

① P10037	PCS	② 702341	PCS
	1		1
		90x50	
	PCS		PCS
	PCS		PCS
	PCS		PCS
	PCS		PCS
	PCS		PCS

1:25

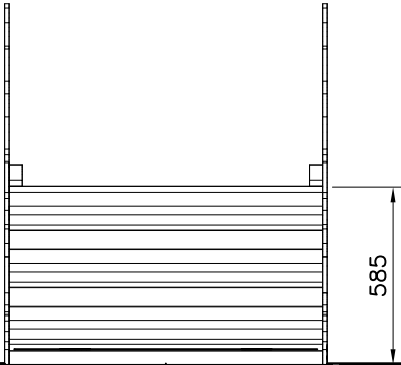

1:25

2

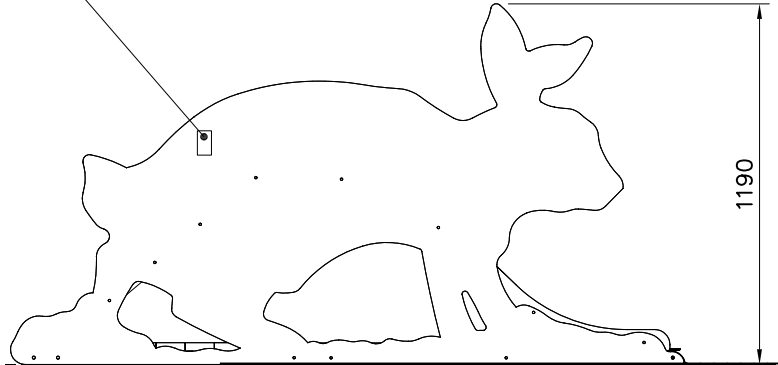

—— EN/AS Impact Area 7.4 m<sup>2</sup>  
 - - - - Falling Space 19.1 m<sup>2</sup>  
 Max Falling Height 1000 mm

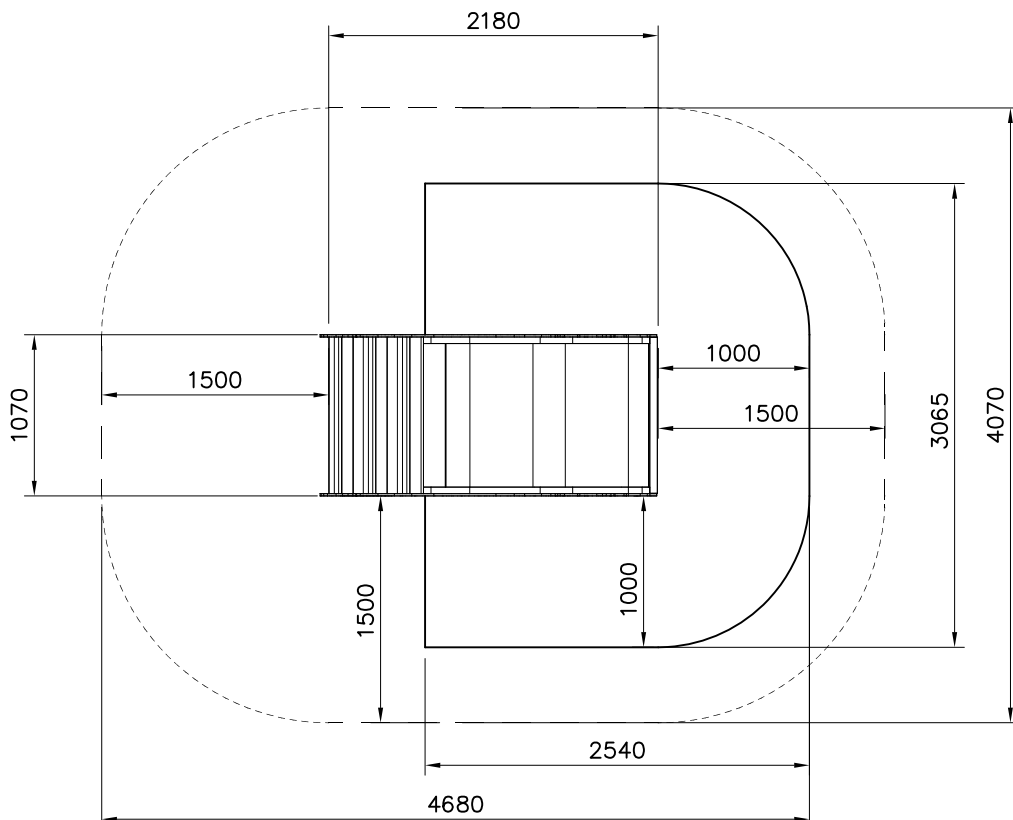
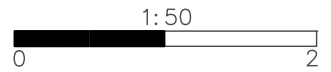

												
<p><b><math>h &lt; 600</math></b></p> <p>Without movement and therefore without Impact Area</p>	<p>Totally hard surfaces.</p> <p>Note. Lappset does <u>not recommend</u> totally hard surfaces at all.</p>	<p>E.g. concrete or asphalt</p> 										
<p><b><math>h &lt; 600</math></b></p> <p>With movement e.g. rocking</p>	<p>Materials with very limited impact attenuating properties.</p>	<p>E.g. wood</p> 										
<p><b><math>h &lt; 1000</math></b></p>	<p>Materials with significant impact attenuating properties.</p>	<p>fine gravel 0–8 mm</p>  <p>grass</p>  <p>unsorted sand</p> 										
<p><b><math>h &lt; 3000</math></b></p>	<p>Loose fill material</p> <p>E.g. sand/gravel 0,25...8 mm D60/D10&lt;3,0 Woodchips 5...30 mm bark 20...80 mm</p>	 <table data-bbox="1021 1691 1332 1792"> <tr> <td><math>\underline{S}</math></td> <td><math>\underline{h}</math></td> </tr> <tr> <td>30 cm</td> <td>&lt; 2,0 m</td> </tr> <tr> <td>40 cm</td> <td>&lt; 3,0 m</td> </tr> </table>	$\underline{S}$	$\underline{h}$	30 cm	< 2,0 m	40 cm	< 3,0 m				
$\underline{S}$	$\underline{h}$											
30 cm	< 2,0 m											
40 cm	< 3,0 m											
	<p>Syntethic granulates</p> <table data-bbox="406 1892 758 2060"> <tr> <td><math>\underline{S}</math></td> <td><math>\underline{h}</math></td> </tr> <tr> <td>40 mm</td> <td>~&gt; 1,2...1,3 m</td> </tr> <tr> <td>50 mm</td> <td>~&gt; 1,5...1,7 m</td> </tr> <tr> <td>60 mm</td> <td>~&gt; 1,8...2,0 m</td> </tr> <tr> <td>70 mm</td> <td>~&gt; 2,1...2,5 m</td> </tr> </table> <p>Note. For accurate values, see manufacturer's instructions.</p>	$\underline{S}$	$\underline{h}$	40 mm	~> 1,2...1,3 m	50 mm	~> 1,5...1,7 m	60 mm	~> 1,8...2,0 m	70 mm	~> 2,1...2,5 m	
$\underline{S}$	$\underline{h}$											
40 mm	~> 1,2...1,3 m											
50 mm	~> 1,5...1,7 m											
60 mm	~> 1,8...2,0 m											
70 mm	~> 2,1...2,5 m											

REMOVE SAFETY SURFACE/SAND/GRAVEL  
TO CHECK FOUNDATION



REMOVE SAFETY SURFACE/SAND/GRAVEL  
TO CHECK FOUNDATION

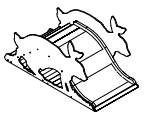

① P10037	PCS
	1

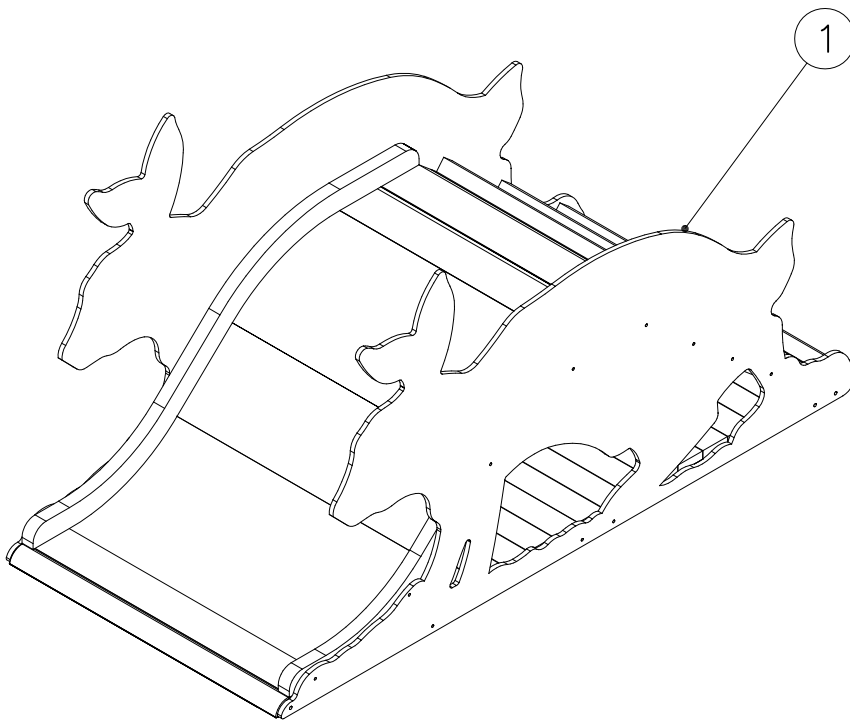
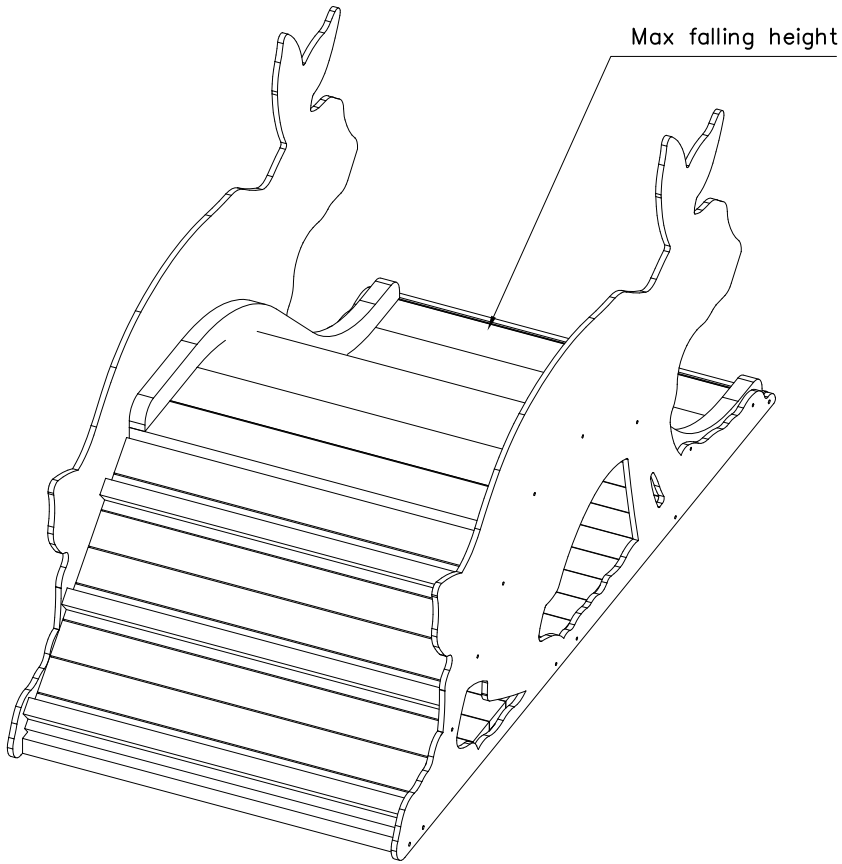

1:25

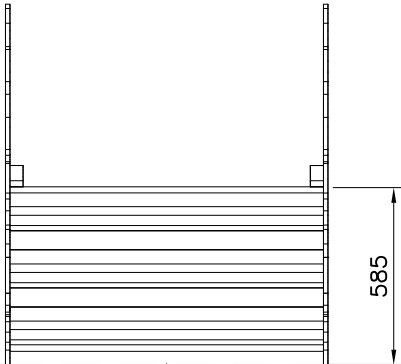

1:25

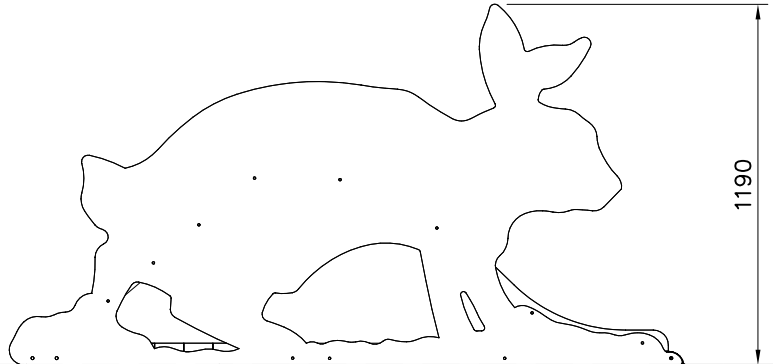

—— EN/AS Impact Area 7.4 m<sup>2</sup>  
 - - - - Falling Space 19.1 m<sup>2</sup>  
 Max Falling Height 1000 mm

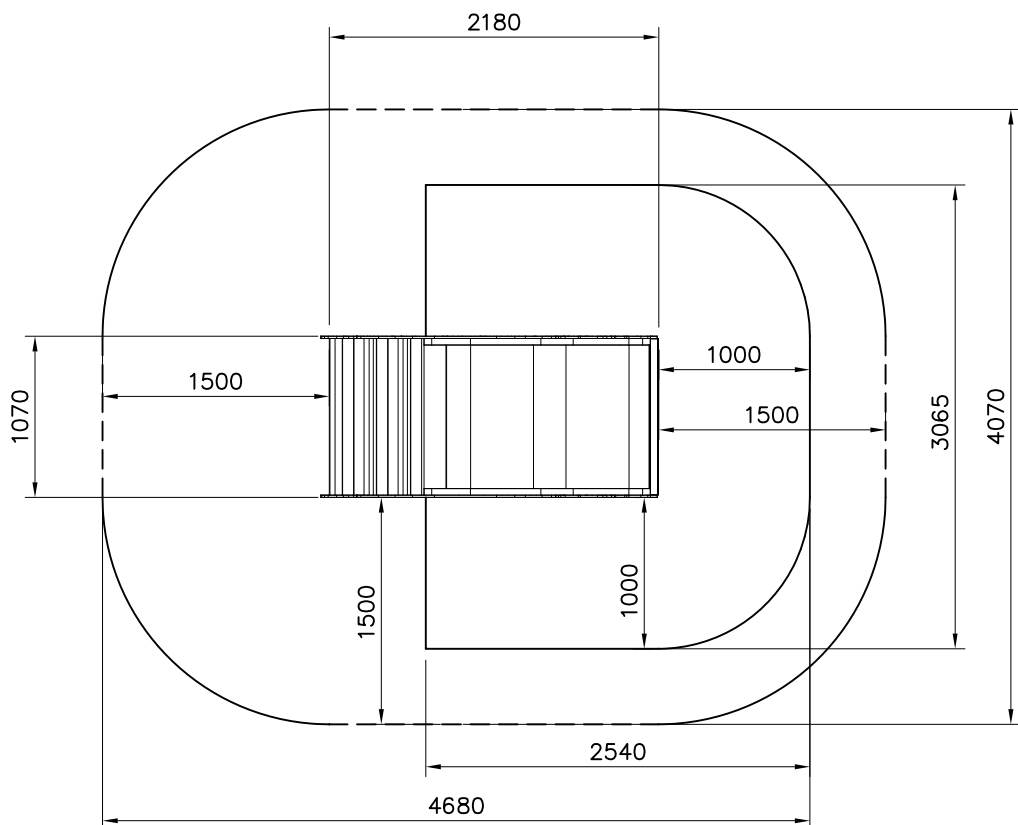
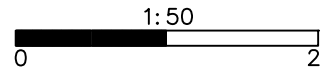



## Tuotekyltti tulee tuotteen mukana yhdellä seuraavista tavoista:

### 1) Metallinen tuotekyltti ja kiinnitysruuvit

- Kiinnitä tuotekyltti ruuveilla tolppaan noin 2 metrin korkeuteen kuvan 1 mukaisesti.

### 2) Tuotekylttitarra

- Puhdista maalattu metalli- tai vaneripinta pölystä ja kosteudesta. Liimaa tarra kuvan 2 mukaisesti.
- Huom. Älä kiinnitä tarraa karheapintaiseen laminaattiin tai maalattuun puuhun.

## Vår produktmärkning levereras på ett av följande sätt:

### 1) Produktskylt i metall

- Fäst skylten med de medföljande skruvarna

### 2) Självhäftande produktetikett

- Rengör den pulverlackerade metallytan eller laminatyten så att den blir fri från smuts och fukt. Fäst etiketten enligt fig. 2.
- Obs! Fäst ej etiketten på detaljer med skrovlig yta eller på målat trä.

## Product label is delivered by one of following ways:

### 1) Metal product label and screws

- Fasten the label with screws.

### 2) Label sticker

- Clean the painted metal or plywood surface from dirt and moisture. Fasten the sticker as shown in the figure 2.
- Note. Do not attach the sticker to rough surfaced laminate or painted wood.

## La plaque d'informations produit est livrée sous l'une de ces 3 formes :

### 1) Plaque métallique et vis

- Fixez la plaque à l'aide des vis.

### 2) Etiquette autocollante

- Avant de coller l'étiquette, nettoyez le composant métallique peint ou la plaque de contreplaqué, de toute saleté. La surface doit être sèche (voir image 2).
- Attention, ne pas coller l'étiquette sur une surface lamellé-collée irrégulière ou sur du bois peint.

## Die Auslieferung des Produktaufklebers erfolgt auf eine dieser Arten:

### 1) Produkt-Schild aus Metall incl. Schrauben

- Die Befestigung des Schildes erfolgt mittels der Schrauben.

### 2) Aufkleber

- Entfernen Sie zunächst Schmutz und Feuchtigkeit vom lackierten Metall bzw. von der Holzoberfläche und bringen Sie den Aufkleber wie im Bild oben rechts beschrieben auf den gesäuberten Untergrund auf.
- Beachten Sie: Bringen Sie den Aufkleber nicht auf raues laminiertes oder lackiertes Holz an.