

# **LAPPSET®**

## **FINNO**

ASENNUSOHJE  
MONTERINGSANSVISNING  
INSTALLATION INSTRUCTION  
AUFBAUANLEITUNG  
NOTICE D'INSTALLATION

DATE: 3.2.2022

### **Q11032-4**

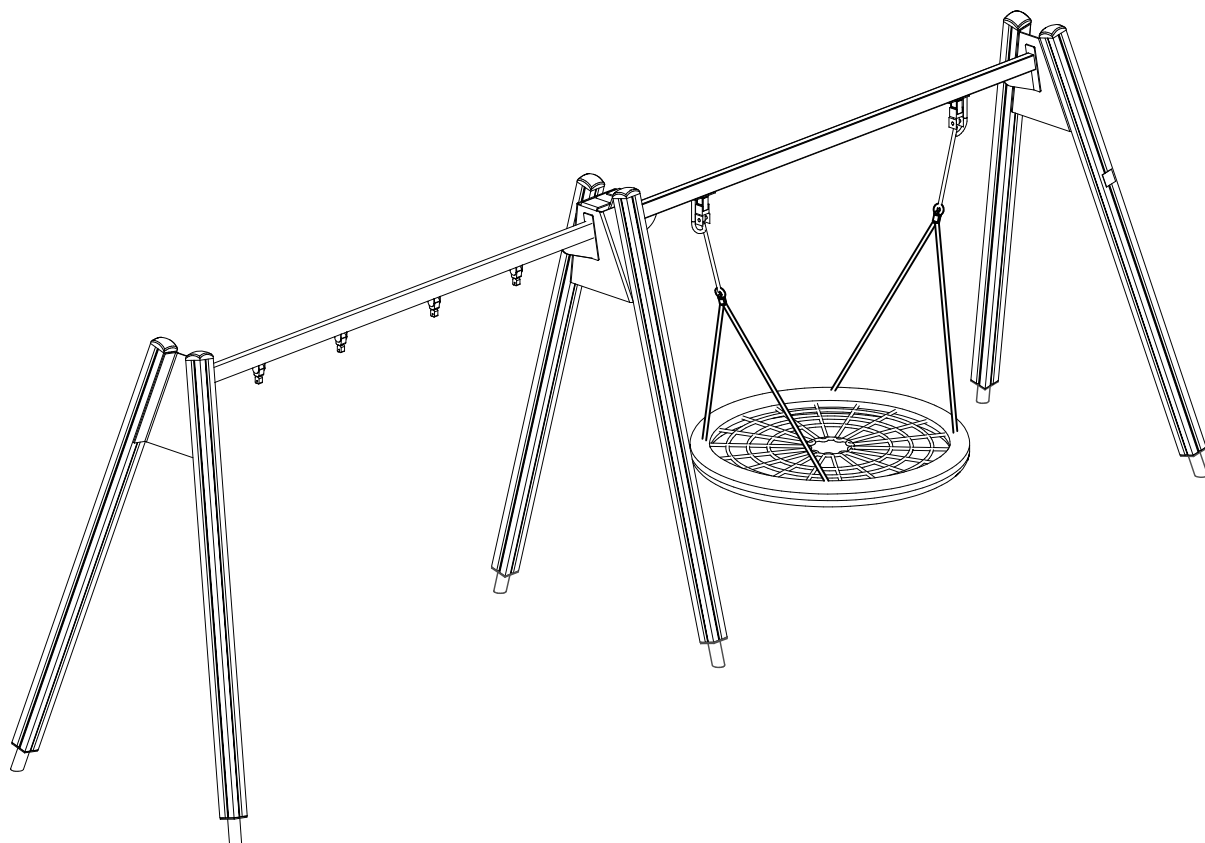

# **LAPPSET®**

## **FINNO**







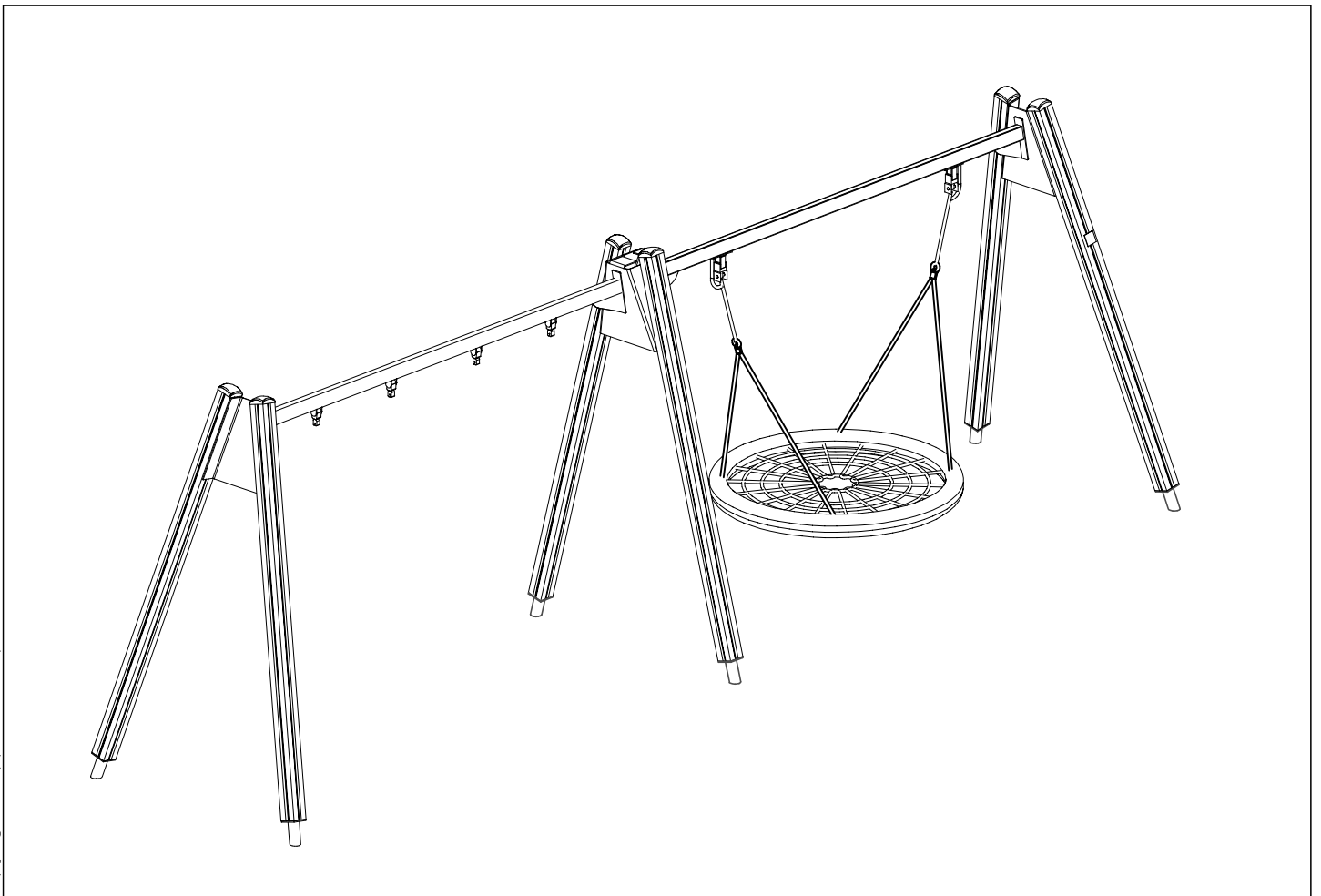





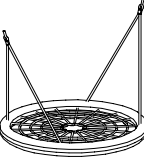

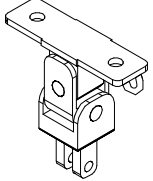

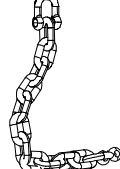
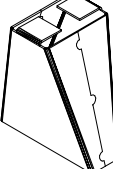

ASENNUSOHJE  
MONTERINGSANSVISNING  
INSTALLATION INSTRUCTION  
AUFBAUANLEITUNG  
NOTICE D'INSTALLATION

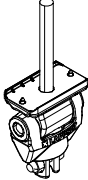
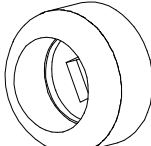
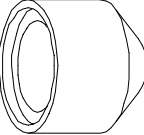
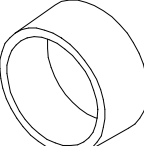
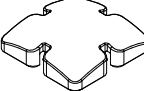
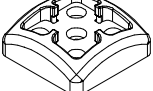
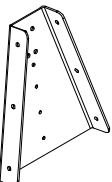
DATE: 21.4.2022

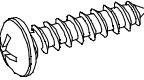
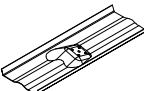
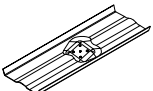
### **Q11032-4**

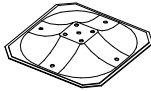
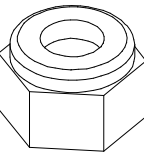

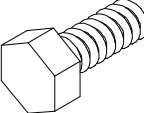
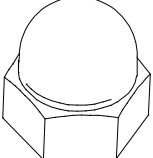
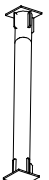
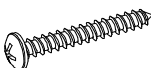
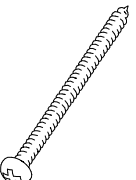
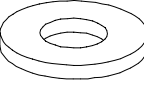
DATE: 21.4.2022

702286  65x65	PCS 1	702533  118x78	PCS 1	706562  L2250	PCS 6	706947  M10	PCS 1	900965  M10	PCS 8	901958  L2940	PCS 2
901959  L2940	PCS 1	902234  M12	PCS 4	903149  M12x30	PCS 8	903577  M12x30	PCS 2	904317  L2940	PCS 1	904333  L2940	PCS 1
904904  Ø45	PCS 4	905090  Ø45	PCS 18	905104  M10	PCS 24	905115  Ø30	PCS 18	905138  L 1000	PCS 6	905196  L 1000	PCS 6
905991  L 1000	PCS 2	906499  M12x110	PCS 4	909347  M12x35	PCS 18	909506  Ø3.5x13	PCS 4	909507  L 1000	PCS 2	909508  L 1000	PCS 2
909511  L650	PCS 2	909519  50x380x380	PCS 2	909637  M10	PCS 24	909638  Ø20/10.5	PCS 64	909639  M10x25	PCS 32	909644  M12	PCS 8
911155  L650	PCS 4	980114  Ø4x20	PCS 4	980131  Ø6x60	PCS 24	980154  Ø24x13	PCS 42	999561  10g	PCS 1		PCS
	PCS		PCS		PCS		PCS		PCS		PCS

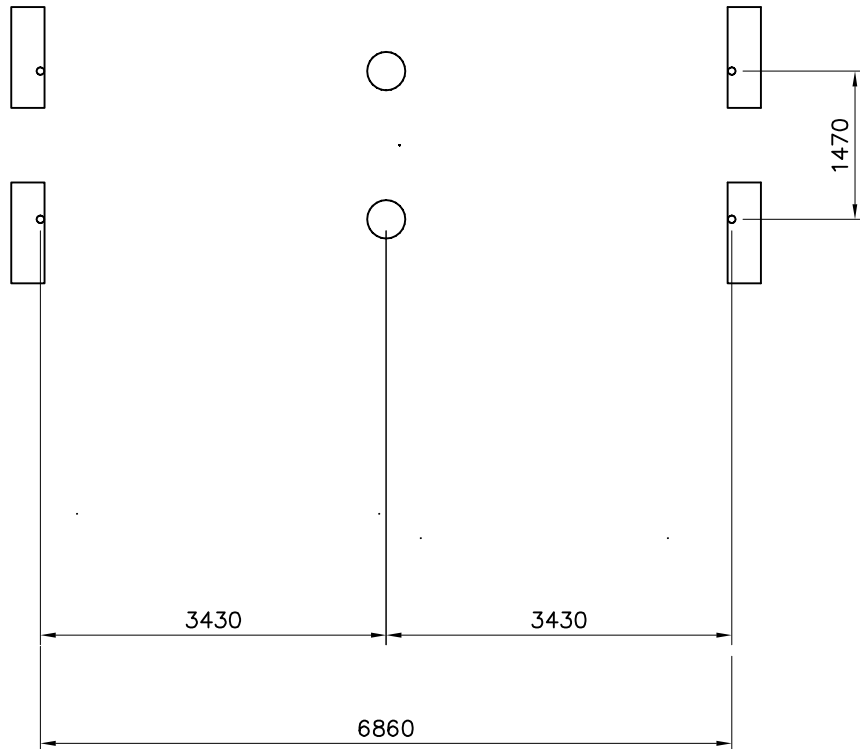
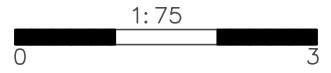

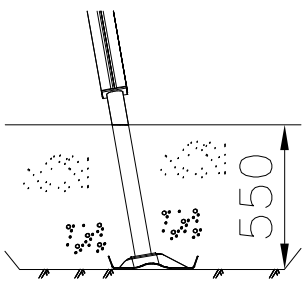
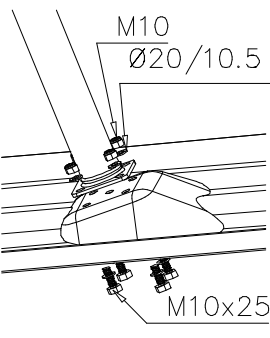
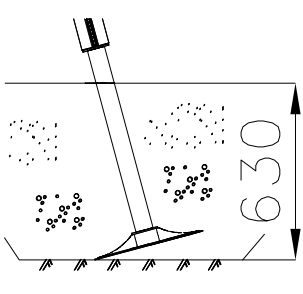
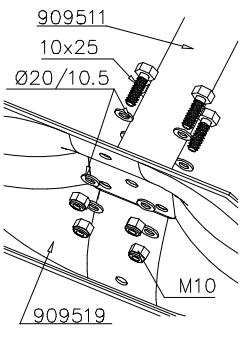
- EN/AS Impact Area 41 m<sup>2</sup>
- ==== Falling Space 41 m<sup>2</sup>  
Max Falling Height 1200 mm



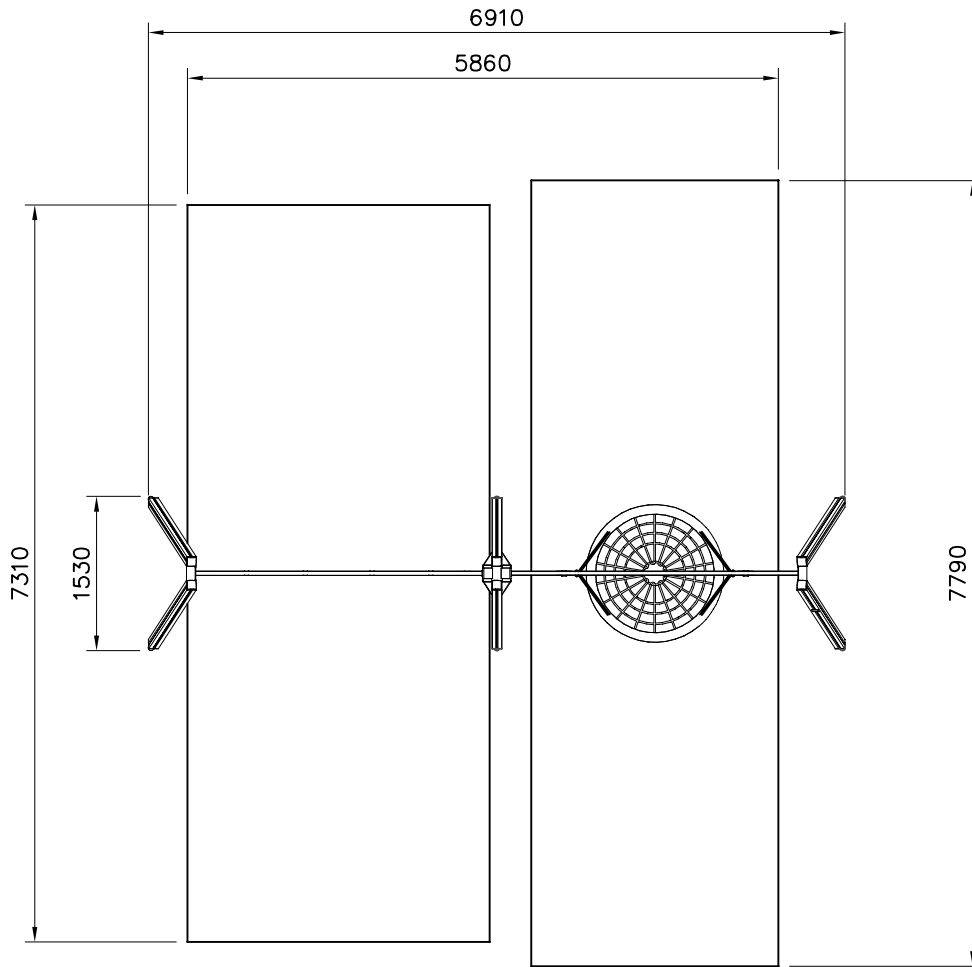
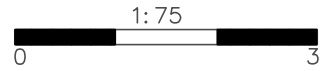

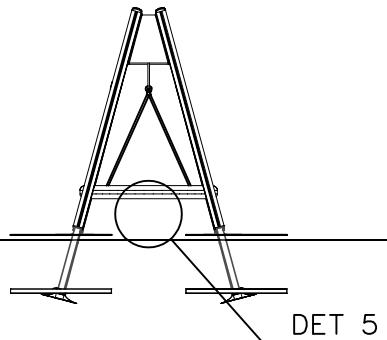
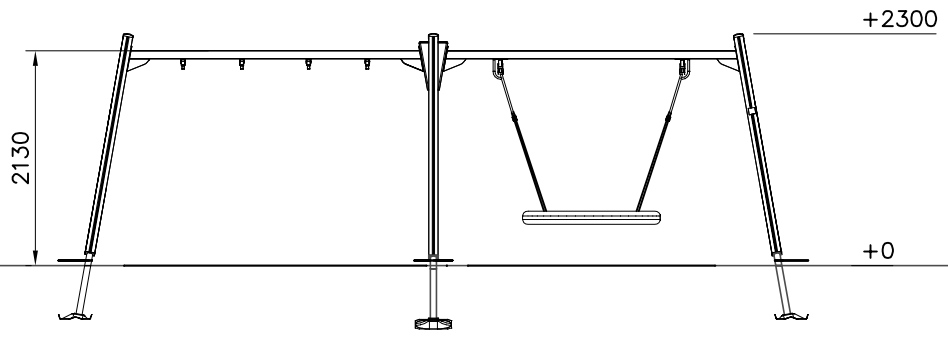

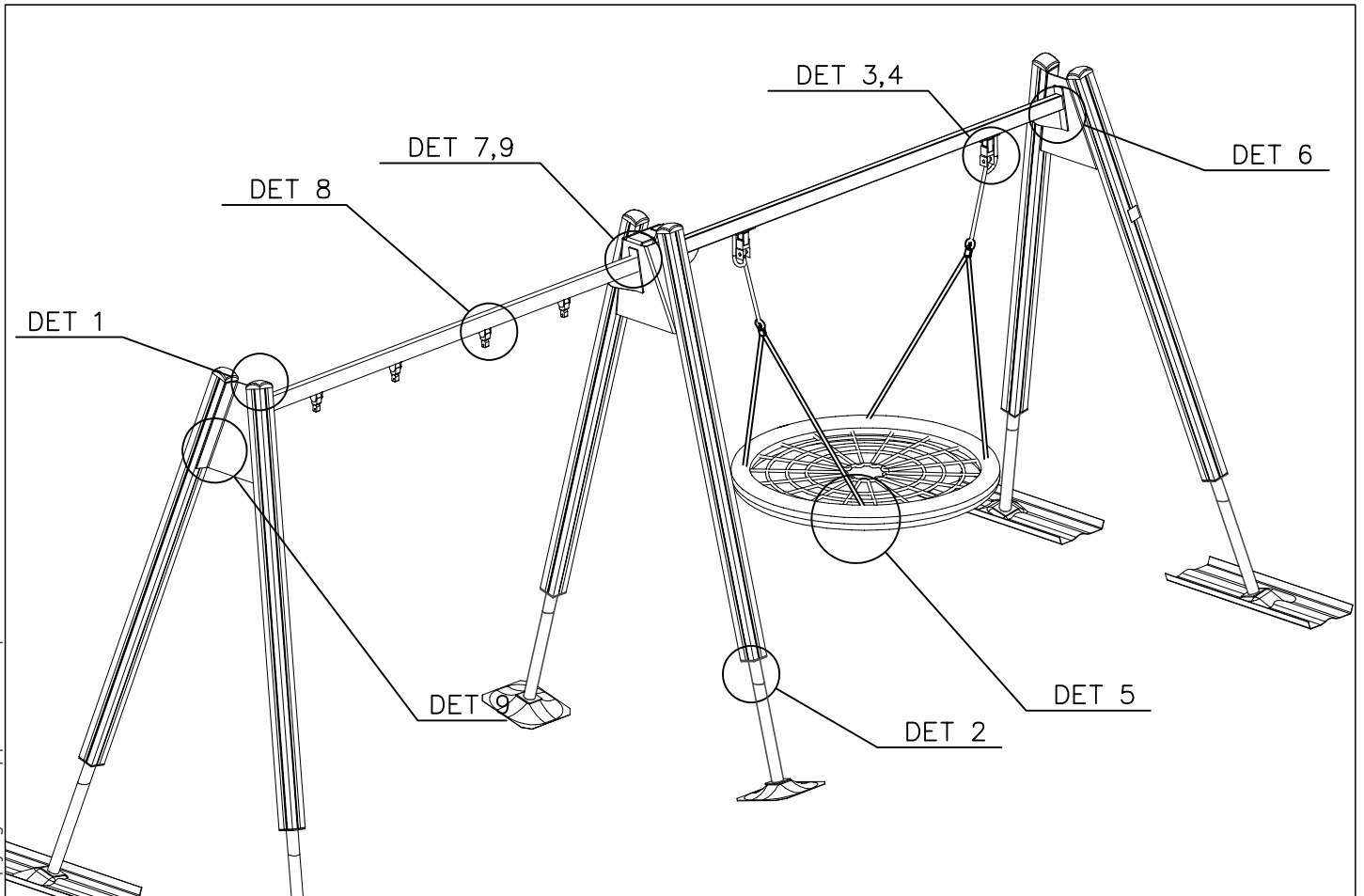
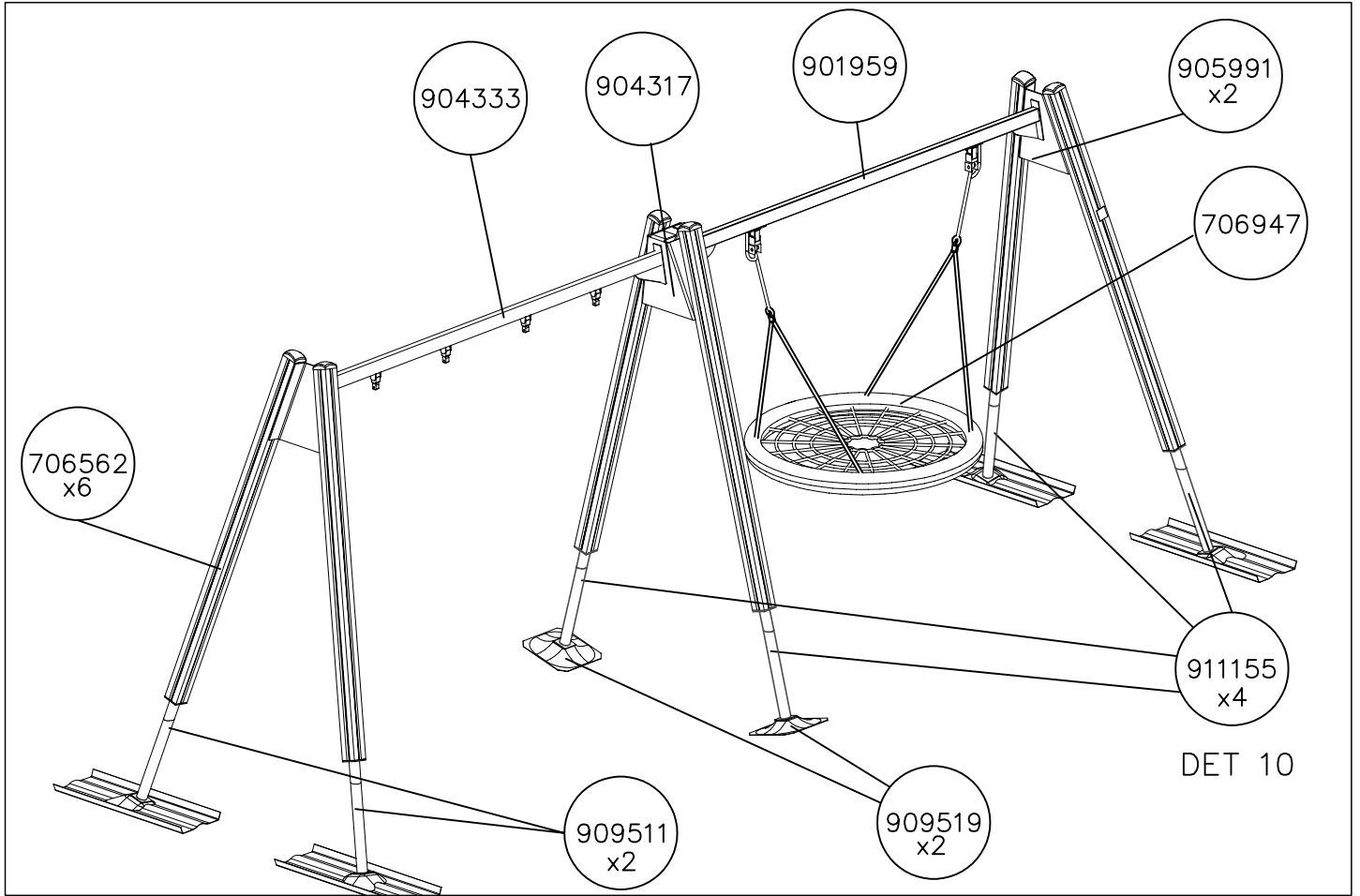



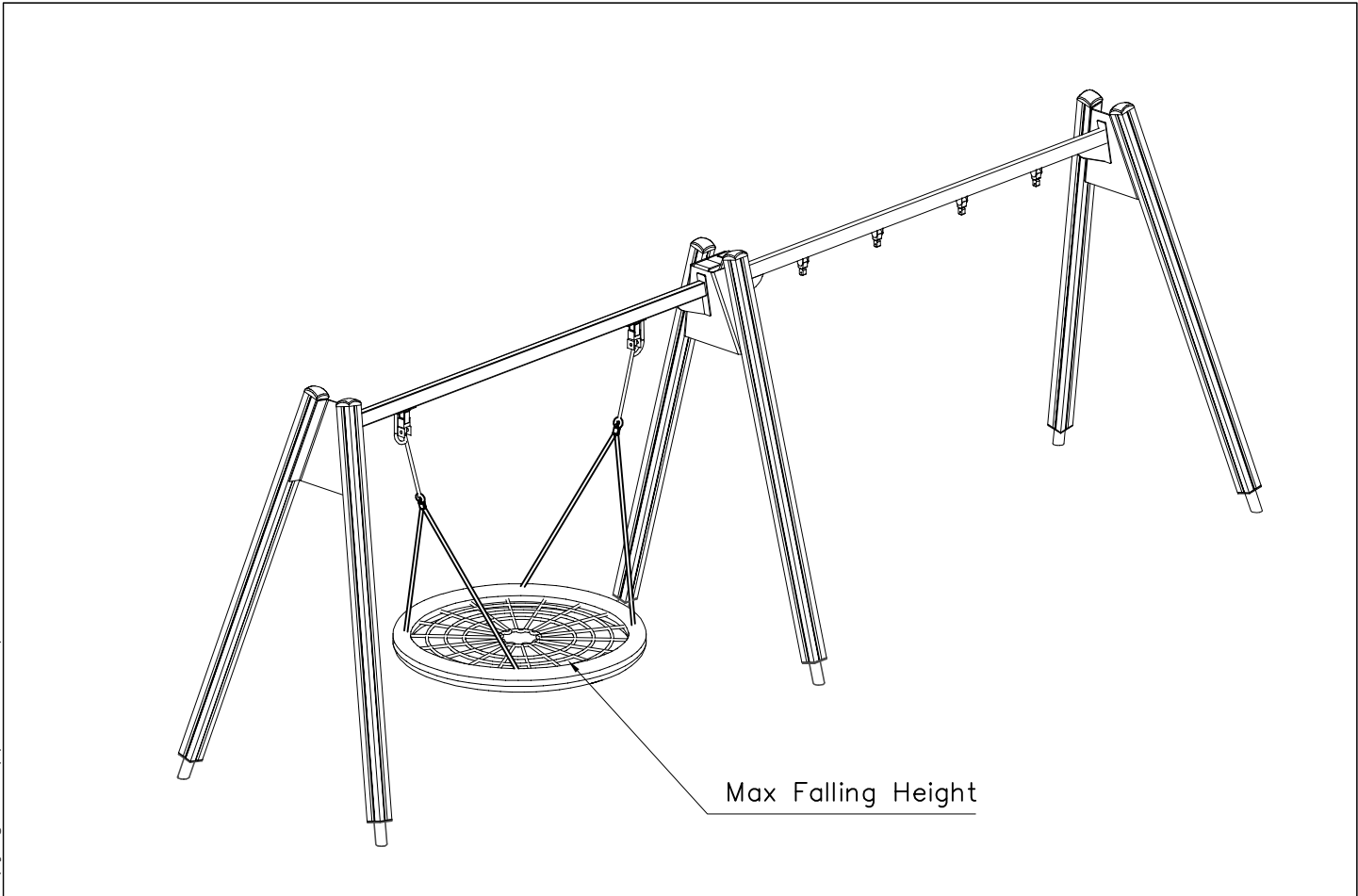

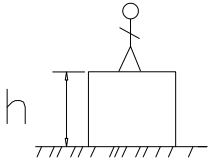
<p>DET 1</p> <p>6x60 980131</p>	<p>DET 2</p> <p>M10 905104 909521</p>	<p>DET 3</p> <p>901958 903577</p>	<p>DET 4</p> <p>M12x110 Ø24/13 901958 M8x35 Ø24/13 M12 M8 CUT EXTRA CHAIN</p>
<p>DET 5</p> <p>&gt;400</p>	<p>DET 6</p> <p>M12 → 80 Nm Ø24/13 M12 M12x30 M10x25 Ø20/10.5 M10 M10 → 45 Nm</p>	<p>DET 7</p> <p>904317</p>	<p>DET 8</p> <p>M12 980154 Ø24/13 904904</p>
<p>DET 9</p> <p>999561 GLUE Ø24/13 12x35 905115 905090</p>	<p>DET 10</p> <p>911155</p>		

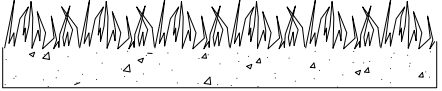
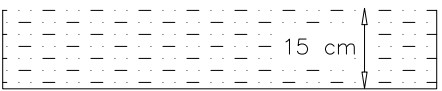
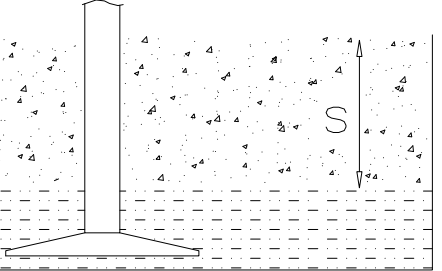
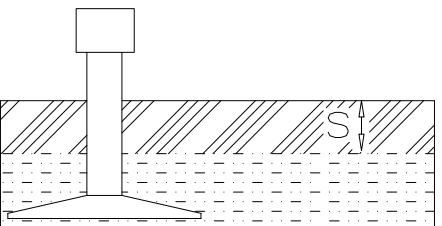

		
<p><b><math>h &lt; 600</math></b></p> <p>Without movement and therefore without Impact Area</p>	<p>Totally hard surfaces.</p> <p>Note. Lappset does <u>not recommend</u> totally hard surfaces at all.</p>	<p>E.g. concrete or asphalt</p> 
<p><b><math>h &lt; 600</math></b></p> <p>With movement e.g. rocking</p>	<p>Materials with very limited impact attenuating properties.</p>	<p>E.g. wood</p> 
<p><b><math>h &lt; 1000</math></b></p>	<p>Materials with significant impact attenuating properties.</p>	<p>fine gravel 0–8 mm</p>  <p>grass</p>  <p>unsorted sand</p> 
<p><b><math>h &lt; 3000</math></b></p>	<p>Loose fill material</p> <p>E.g. sand/gravel 0,25...8 mm D60/D10&lt;3,0 Woodchips 5...30 mm bark 20...80 mm</p>	 <p><math>\underline{S}</math>                      <math>\underline{h}</math></p> <p>30 cm                      &lt; 2,0 m</p> <p>40 cm                      &lt; 3,0 m</p>
	<p>Syntethic granulates</p> <p><math>\underline{S}</math>                      <math>\underline{h}</math></p> <p>40 mm ~&gt; 1,2...1,3 m</p> <p>50 mm ~&gt; 1,5...1,7 m</p> <p>60 mm ~&gt; 1,8...2,0 m</p> <p>70 mm ~&gt; 2,1...2,5 m</p> <p>Note. For accurate values, see manufacturer's instructions.</p>	

REMOVE SAFETY SURFACE/SAND/GRAVEL  
TO CHECK FOUNDATION

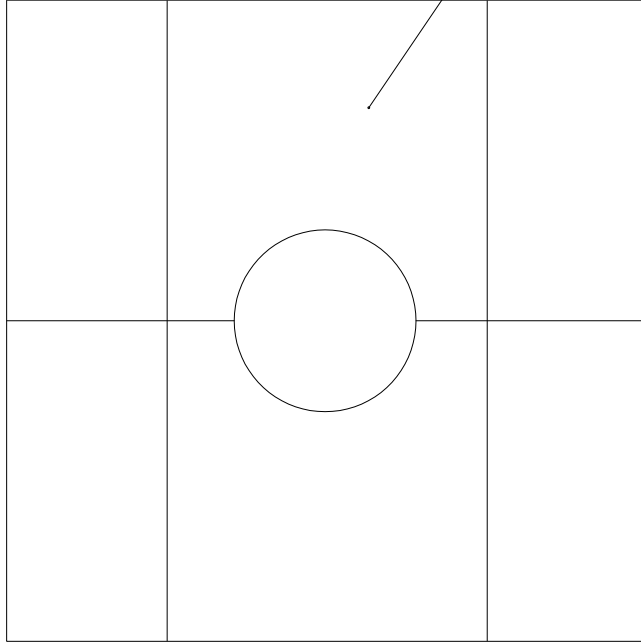

REMOVE SAFETY SURFACE/SAND/GRAVEL  
TO CHECK FOUNDATION



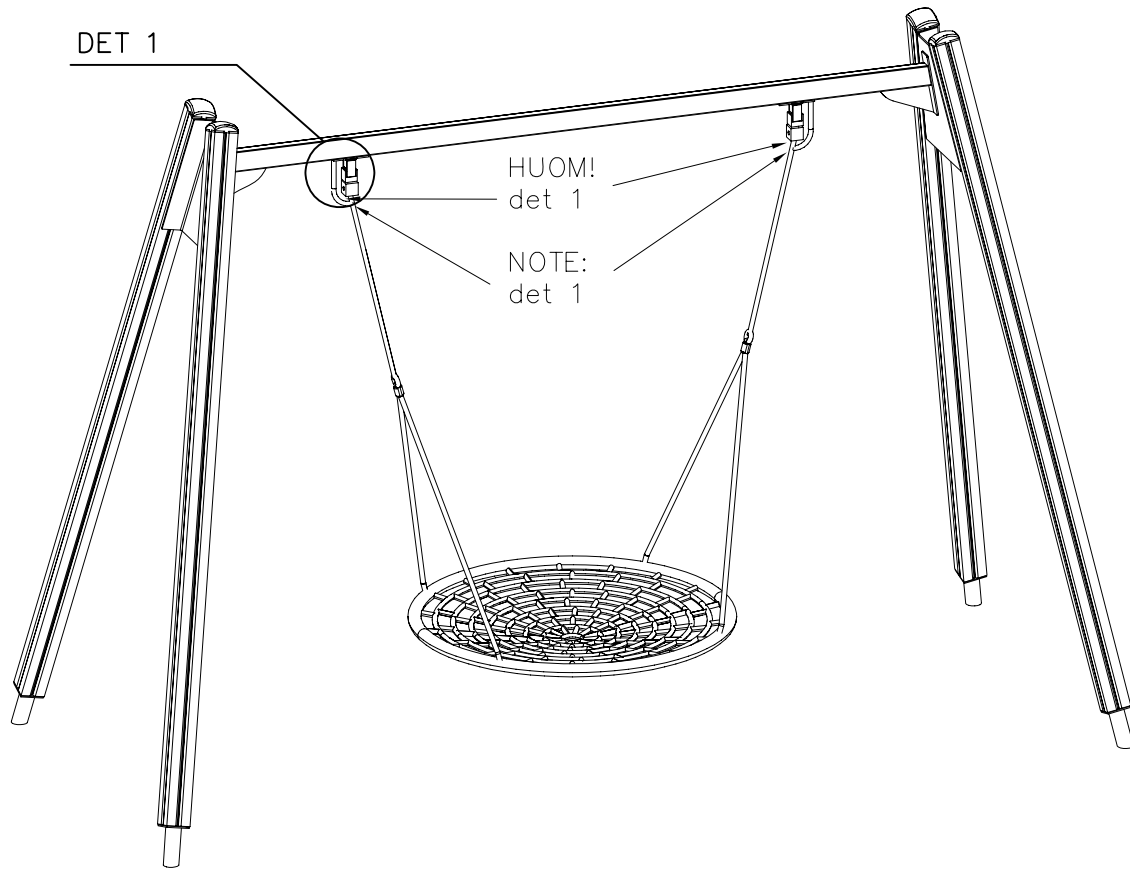

DET 1

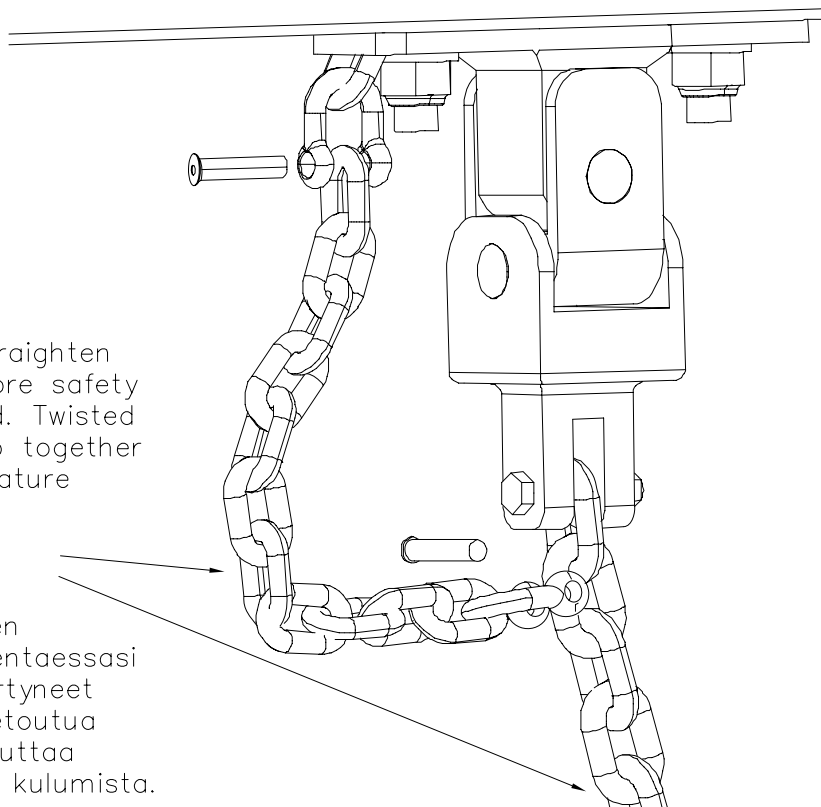

Note:  
Make sure to straighten both chains before safety chain is installed. Twisted chains may wrap together and cause premature wear.

Huom!  
Varmistu ketjujen suoruudesta asentaessasi turvaketjua. Kiertyneet ketjut voivat kietoutua toisiinsa ja aiheuttaa ketjujen nopeaa kulumista.

**LAPPSET®**  
**BETON FOUNDATION**

**FOOT**

DATE: 27.10.2015

**1(1)**

② 905104	PCS		PCS
	4		
 M10	PCS		PCS



905104

**Tuotekyltti tulee tuotteen mukana yhdellä seuraavista tavoista:****1) Metallinen tuotekyltti ja kiinnitysruuvit**

- Kiinnitä tuotekyltti ruuveilla tolppaan noin 2 metrin korkeuteen kuvan 1 mukaisesti.

**2) Tuotekylttitarra**

- Puhdista maalattu metalli- tai vaneripinta pölystä ja kosteudesta. Liimaa tarra kuvan 2 mukaisesti.
- Huom. Älä kiinnitä tarraa karheapintaiseen laminaattiin tai maalattuun puuhun.

**Vår produktmärkning levereras på ett av följande sätt:****1) Produktskylt i metall**

- Fäst skylten med de medföljande skruvarna

**2) Självhäftande produktetikett**

- Rengör den pulverlackerade metallytan eller laminatyten så att den blir fri från smuts och fukt. Fäst etiketten enligt fig. 2.
- Obs! Fäst ej etiketten på detaljer med skrovlig yta eller på målat trä.

**Product label is delivered by one of following ways:****1) Metal product label and screws**

- Fasten the label with screws.

**2) Label sticker**

- Clean the painted metal or plywood surface from dirt and moisture. Fasten the sticker as shown in the figure 2.
- Note. Do not attach the sticker to rough surfaced laminate or painted wood.

**La plaque d'informations produit est livrée sous l'une de ces 3 formes :****1) Plaque métallique et vis**

- Fixez la plaque à l'aide des vis.

**2) Etiquette autocollante**

- Avant de coller l'étiquette, nettoyez le composant métallique peint ou la plaque de contreplaqué, de toute saleté. La surface doit être sèche (voir image 2).
- Attention, ne pas coller l'étiquette sur une surface lamellé-collée irrégulière ou sur du bois peint.

**Die Auslieferung des Produktaufklebers erfolgt auf eine dieser Arten:****1) Produkt-Schild aus Metall incl. Schrauben**

- Die Befestigung des Schildes erfolgt mittels der Schrauben.

**2) Aufkleber**

- Entfernen Sie zunächst Schmutz und Feuchtigkeit vom lackierten Metall bzw. von der Holzoberfläche und bringen Sie den Aufkleber wie im Bild oben rechts beschrieben auf den gesäuberten Untergrund auf.
- Beachten Sie: Bringen Sie den Aufkleber nicht auf raues laminiertes oder lackiertes Holz an.