

# **LAPPSET®**

## **SPORT**







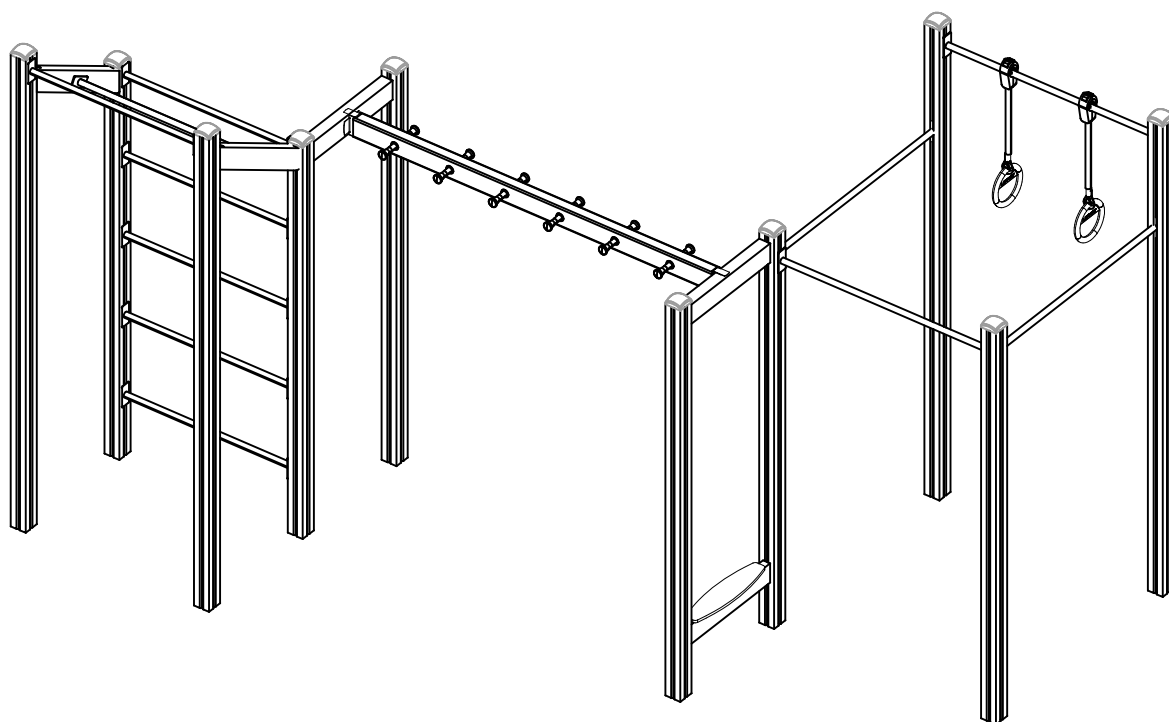

ASENNUSOHJE  
MONTERINGSANSVISNING  
INSTALLATION INSTRUCTION  
AUFBAUANLEITUNG  
NOTICE D'INSTALLATION

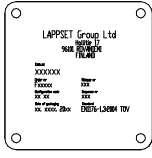
DATE: 10.3.2022

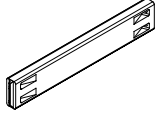
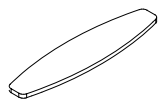
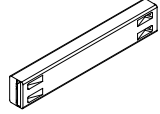
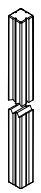
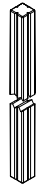
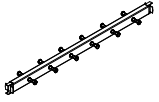
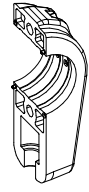
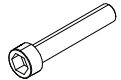
### **Q16081**

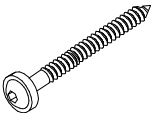
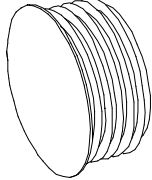
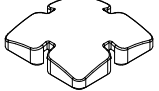
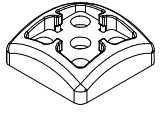
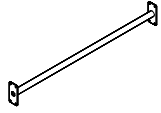
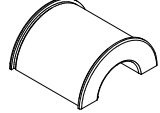
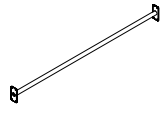
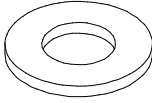
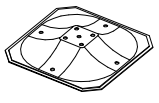
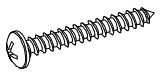
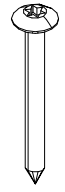
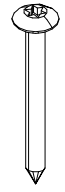
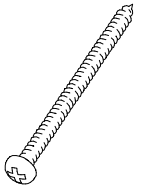

DATE: 10.3.2022

702286	PCS	705040	PCS	706439-602	PCS	706453	PCS	706512-602	PCS	706568-602	PCS
	1		2		1		1		2		6
65x65		Ø16x764		L 704		15x145x600		70x120x704		93x93x3000	
706790-602	PCS	707290-602	PCS	902195	PCS	902232	PCS	902233	PCS	903093	PCS
	4		1		4		2		2		16
93x93x3500		127x300x2355		150x50x50		M10x55		M10x30		Ø8x90	
905103	PCS	905138	PCS	905196	PCS	905838-217	PCS	906006	PCS	908017-217	PCS
	4		10		10		7		4		4
PT-28/32-H		GRAY		GRAY		L 1060		Ø64/36,4x59		L 1315	
909256	PCS	909519	PCS	980114	PCS	980123	PCS	980128	PCS	980131	PCS
	100		10		4		92		12		40
Ø16/8.4		50x380x380		Ø4x20		Ø7x60		Ø7x40		Ø6x60	
980161	PCS	P10639-602	PCS	P10640-602	PCS		PCS		PCS		PCS
	4		1		1						
M10		70x120x892		70x120x892							
	PCS		PCS		PCS		PCS		PCS		PCS
	PCS		PCS		PCS		PCS		PCS		PCS

EN/AS Impact Area 51.2 m<sup>2</sup>

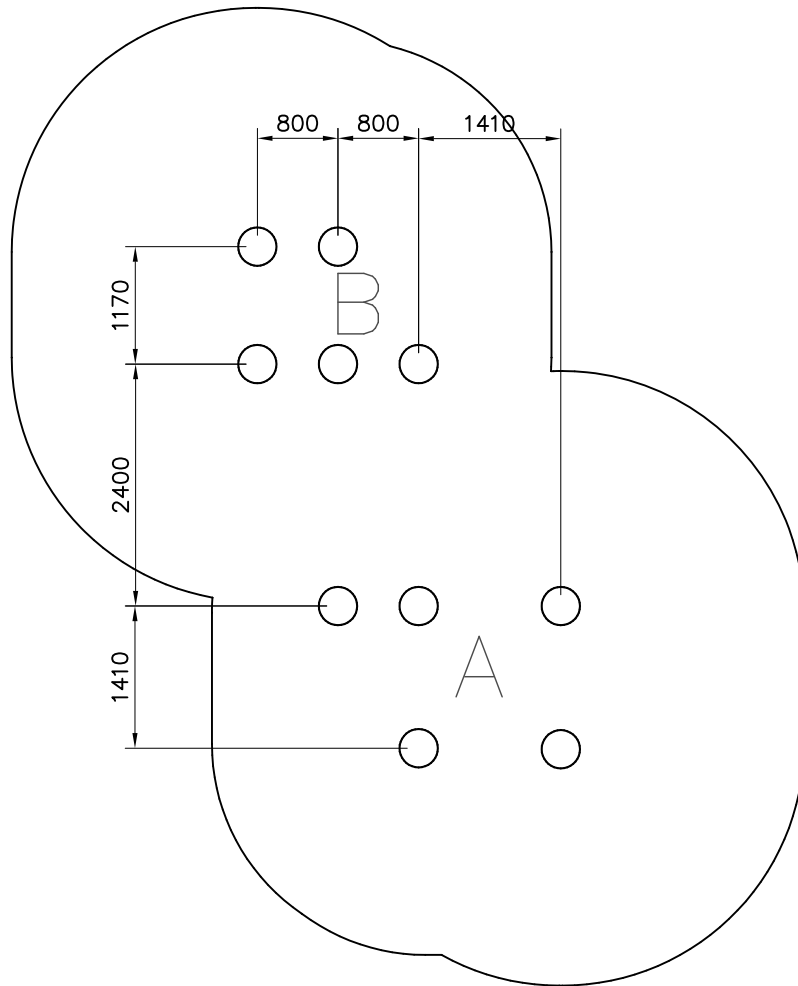
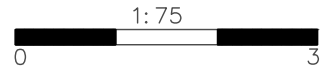

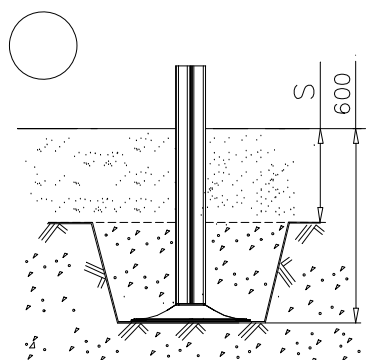
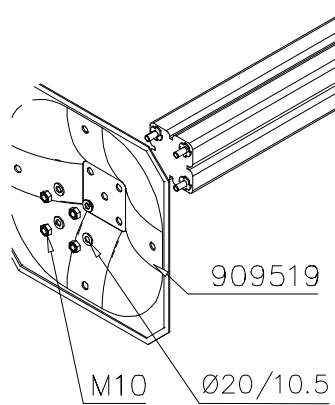
- EN/AS Impact Area 51.2 m<sup>2</sup>
- - - - Falling Space 51.3 m<sup>2</sup>  
Max Falling Height 2880 mm



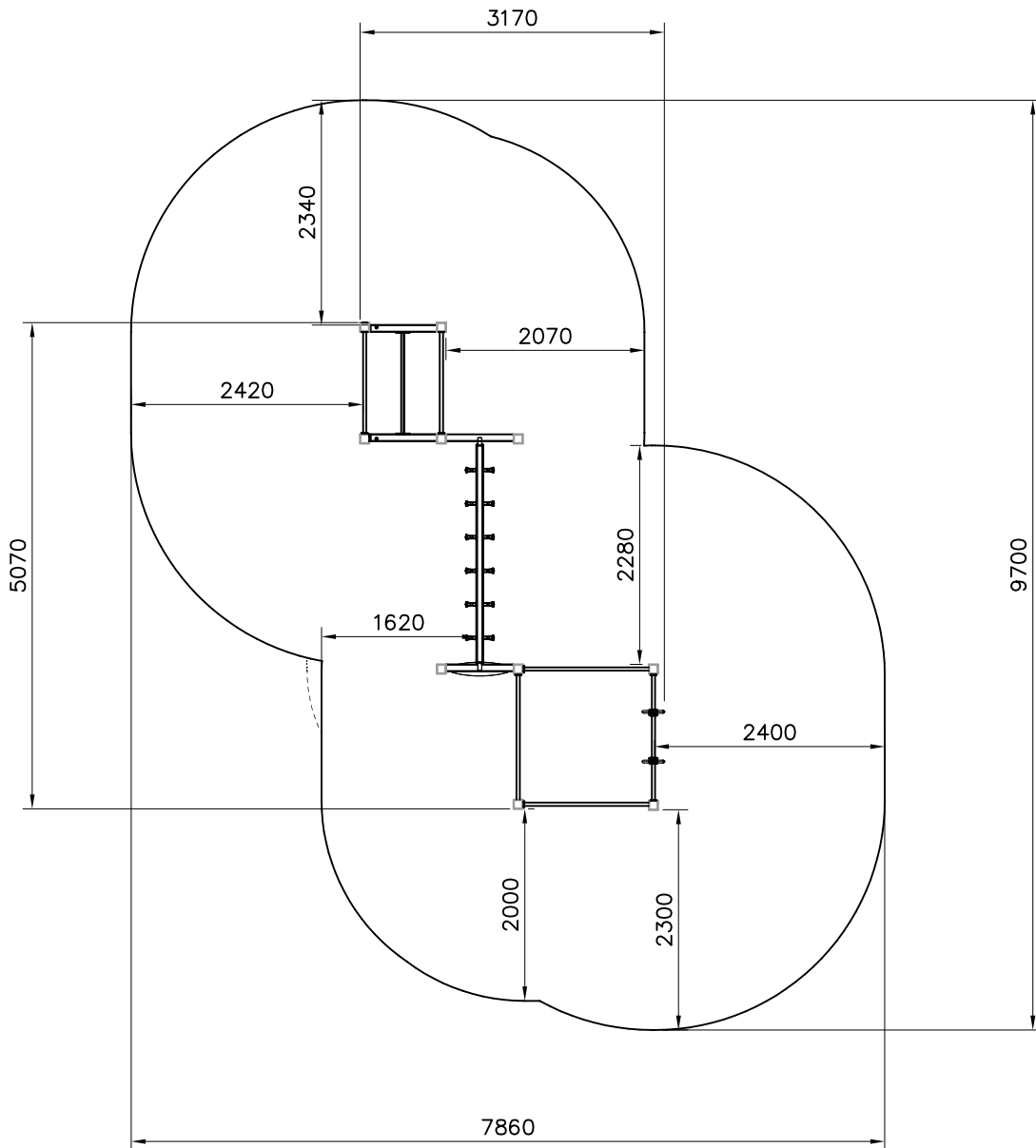

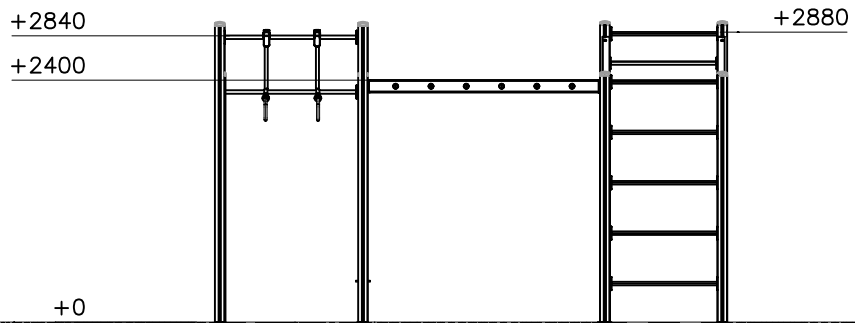
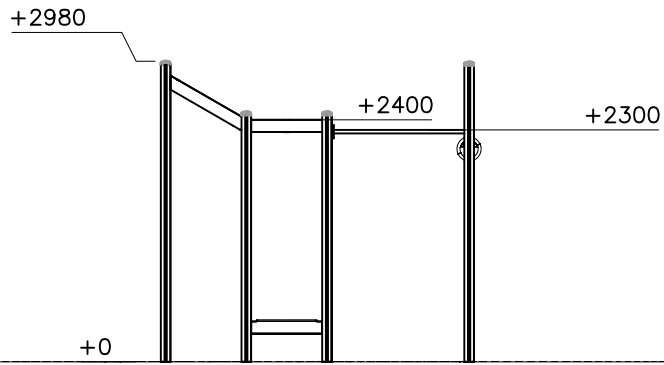

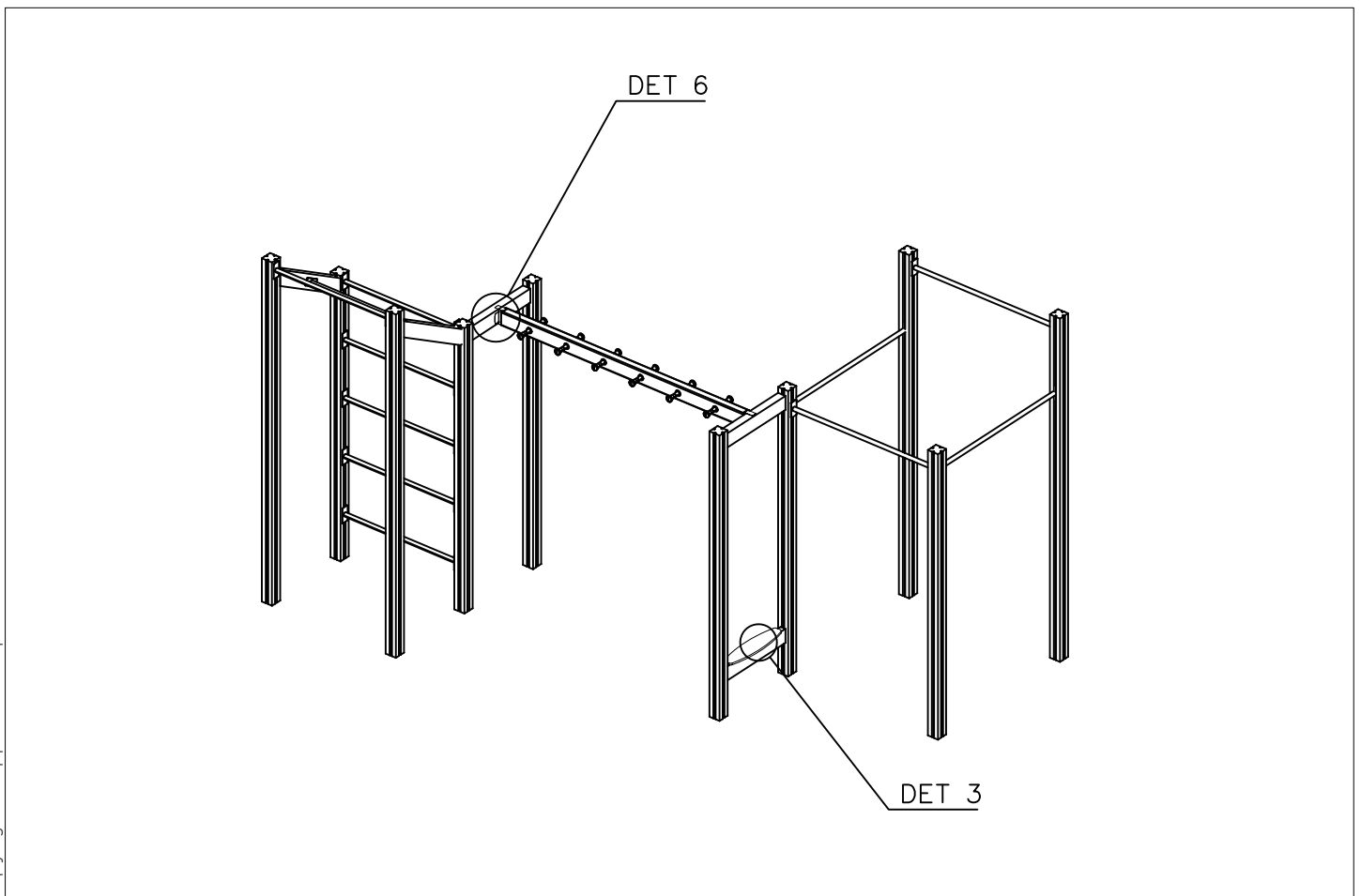
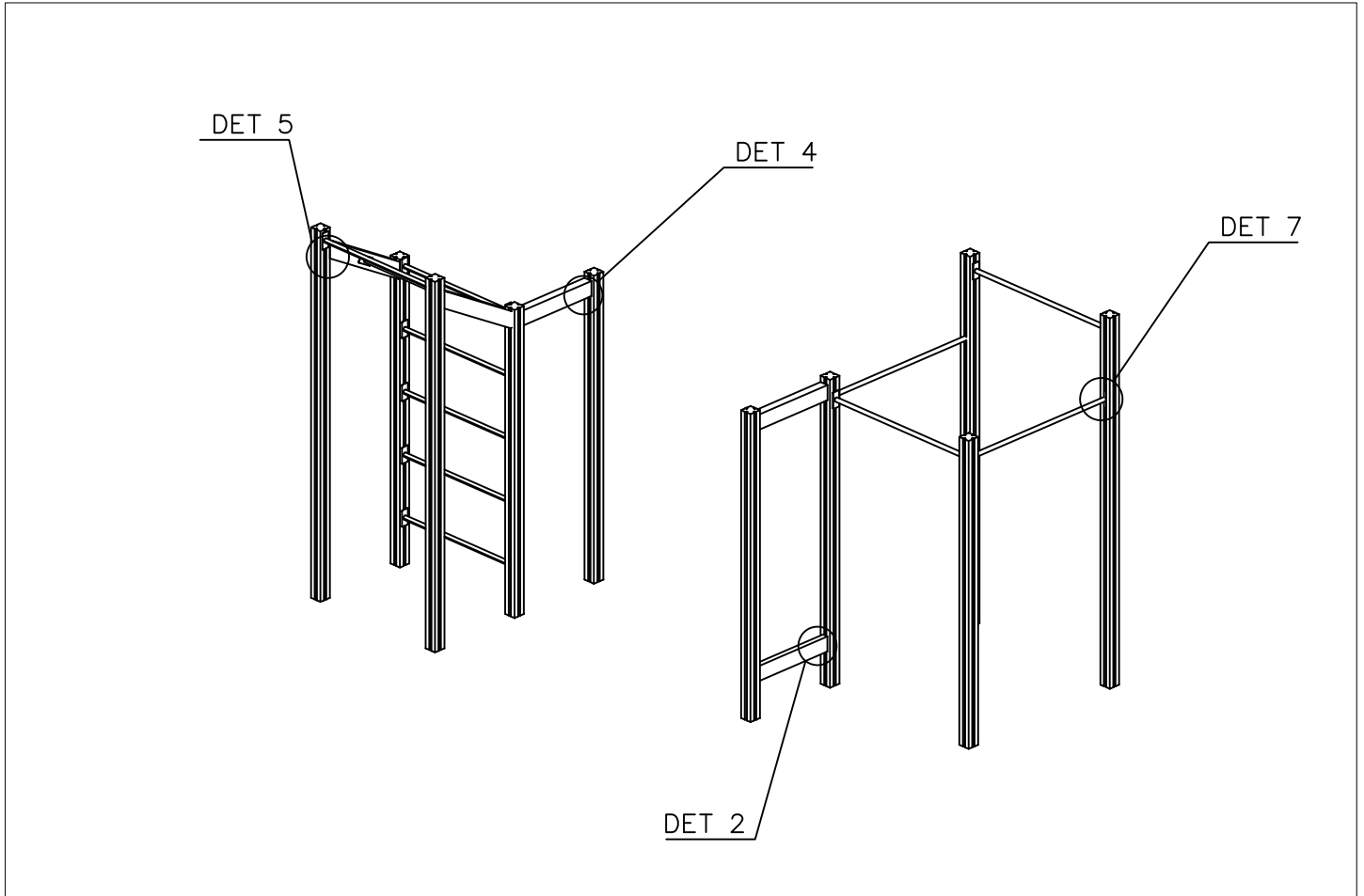
<p>DET 1</p> <p>905138 Ø6x60 (980131) 905196</p>	<p>DET 2</p> <p>Ø8x90 (903093)</p>	<p>DET 3</p> <p>Ø7x60 (980123) 706453</p>	<p>DET 4</p> <p>Ø8x90 (903093)</p>
<p>DET 5</p> <p>905103 Ø8x90 (903093) 707859</p>	<p>DET 6</p> <p>Ø7x40 (980128) Ø16/8.4 (909256)</p>	<p>DET 7</p> <p>Ø7x60 (980123) Ø16/8.4 (909256)</p>	



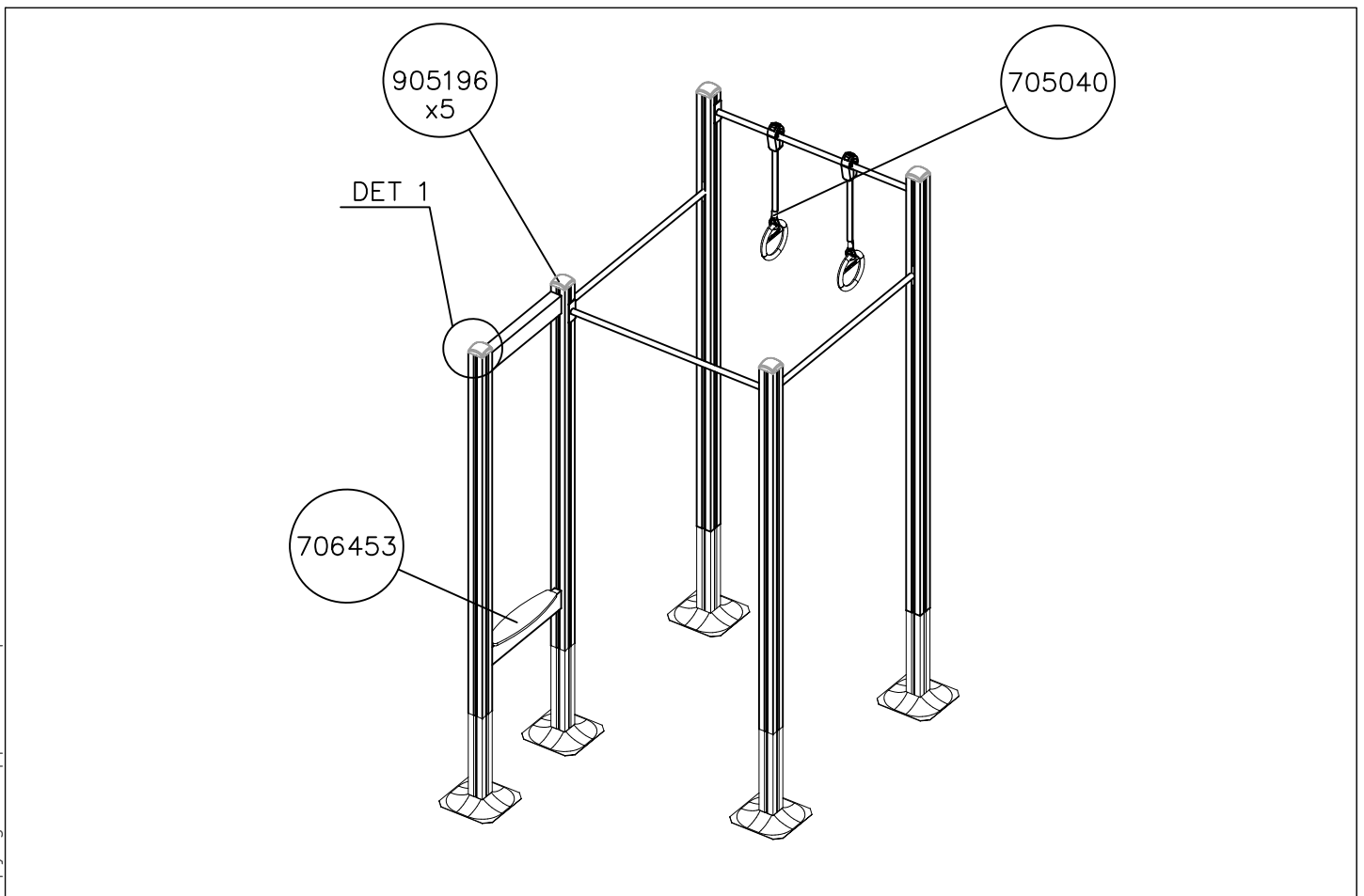
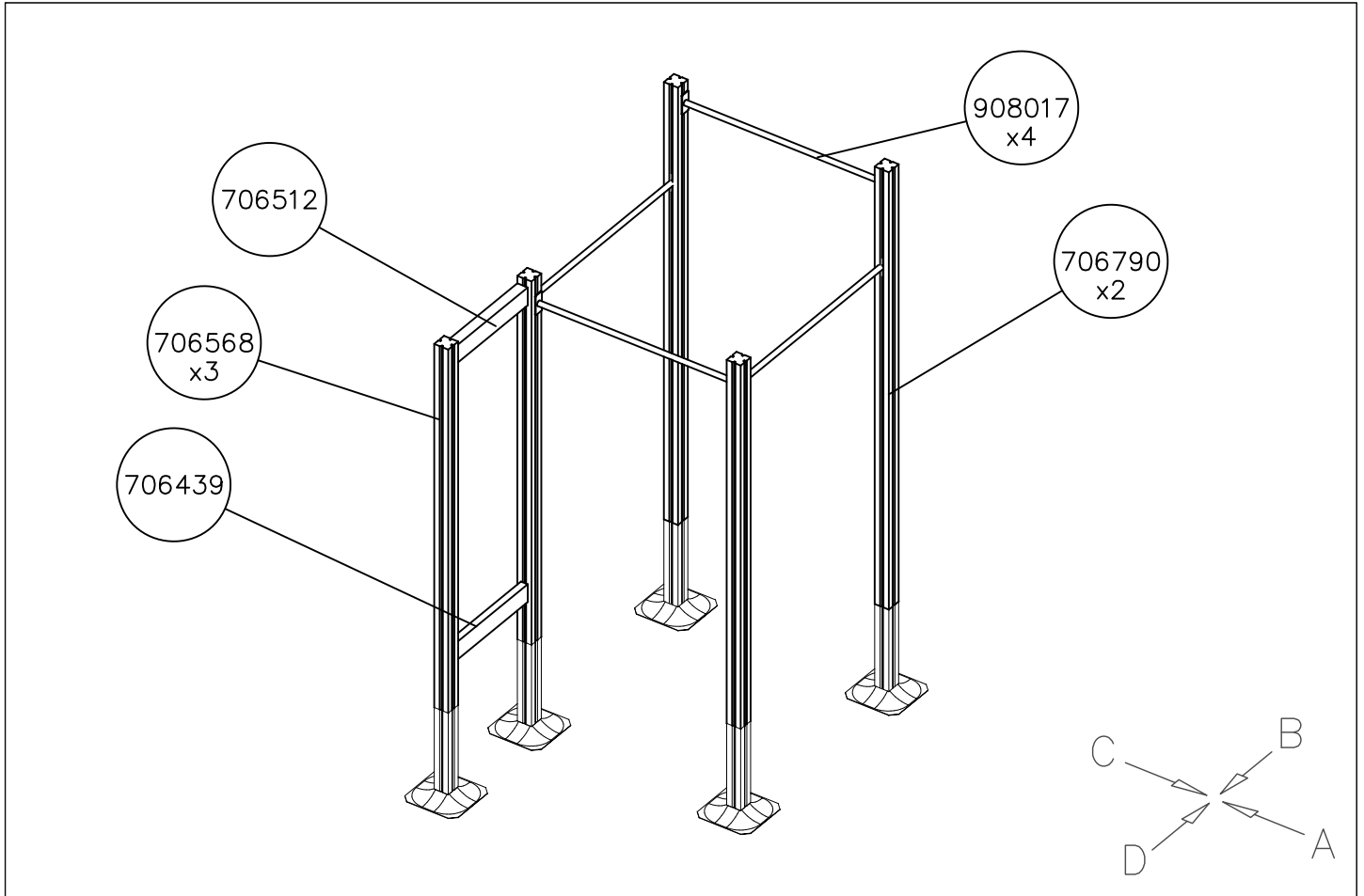

DATE: 10.3.2022

1:50

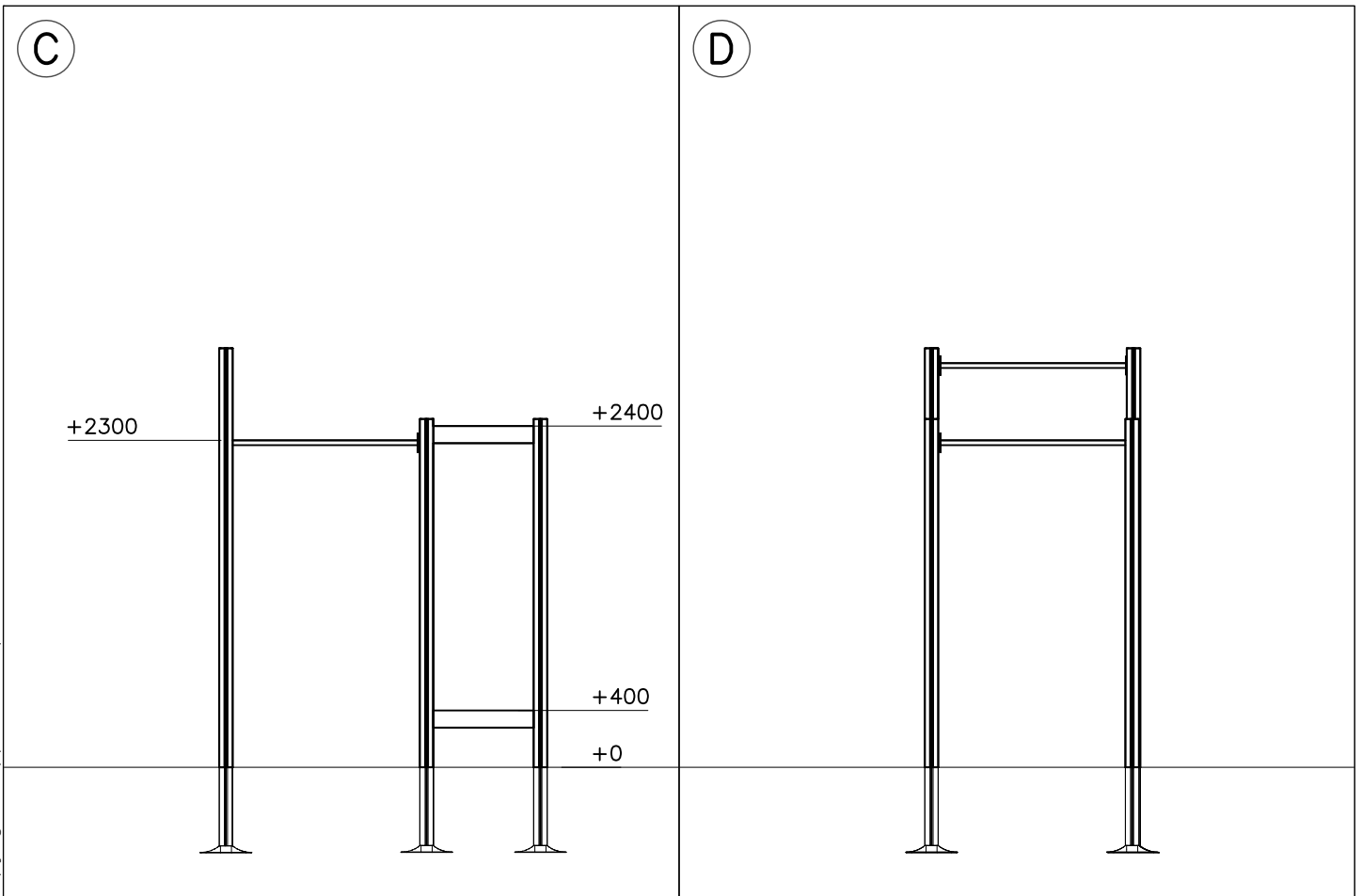
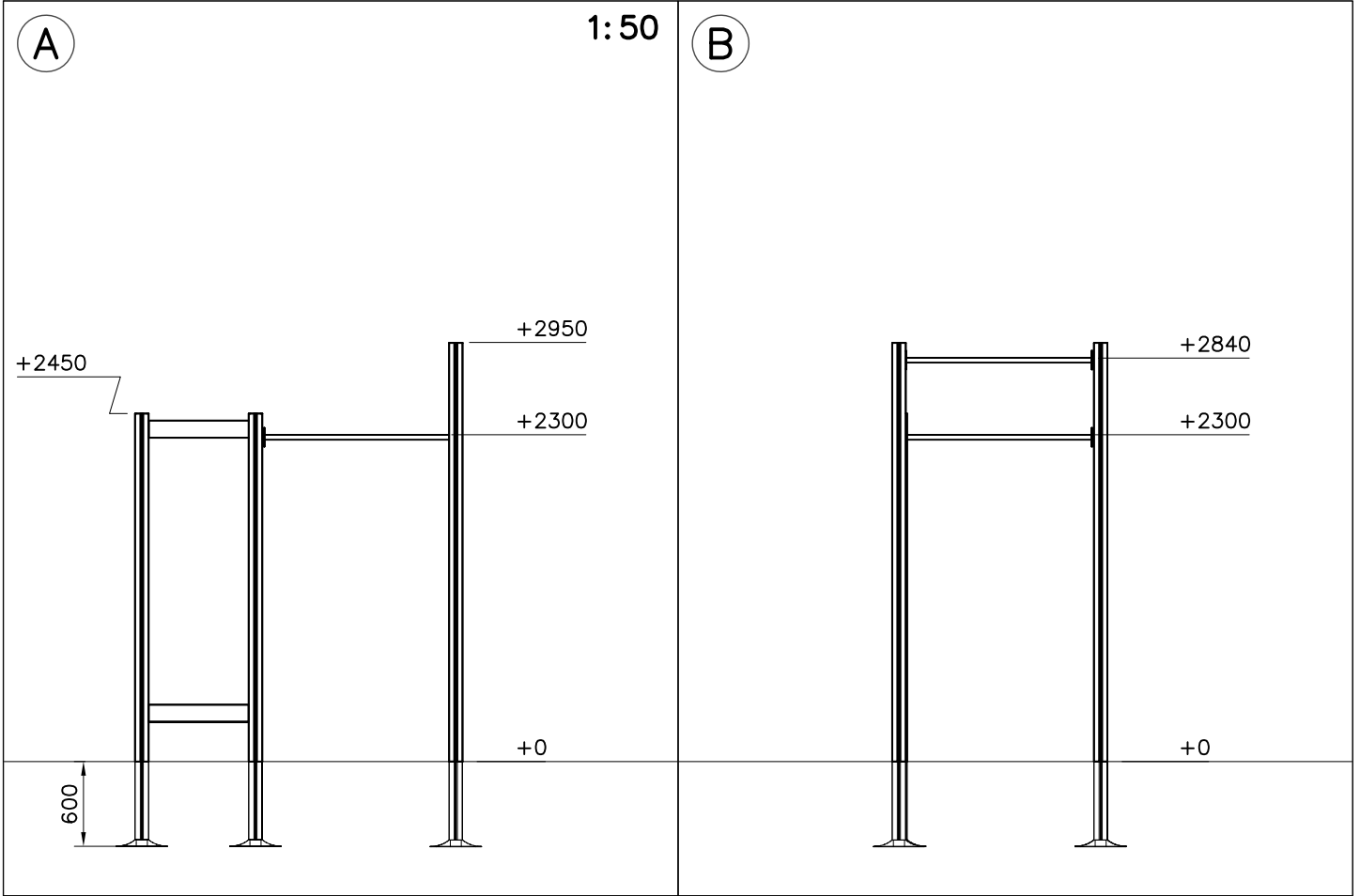

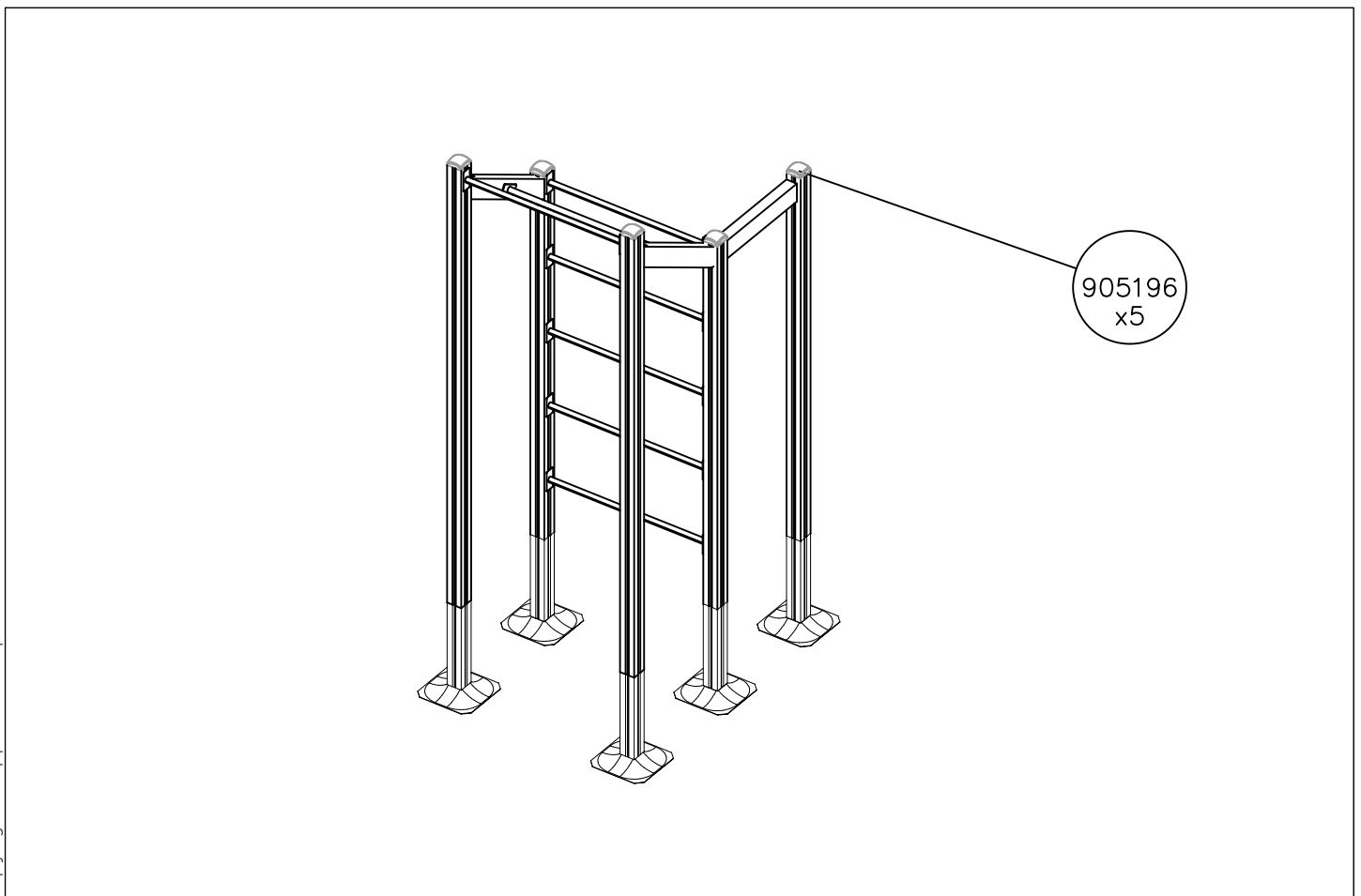
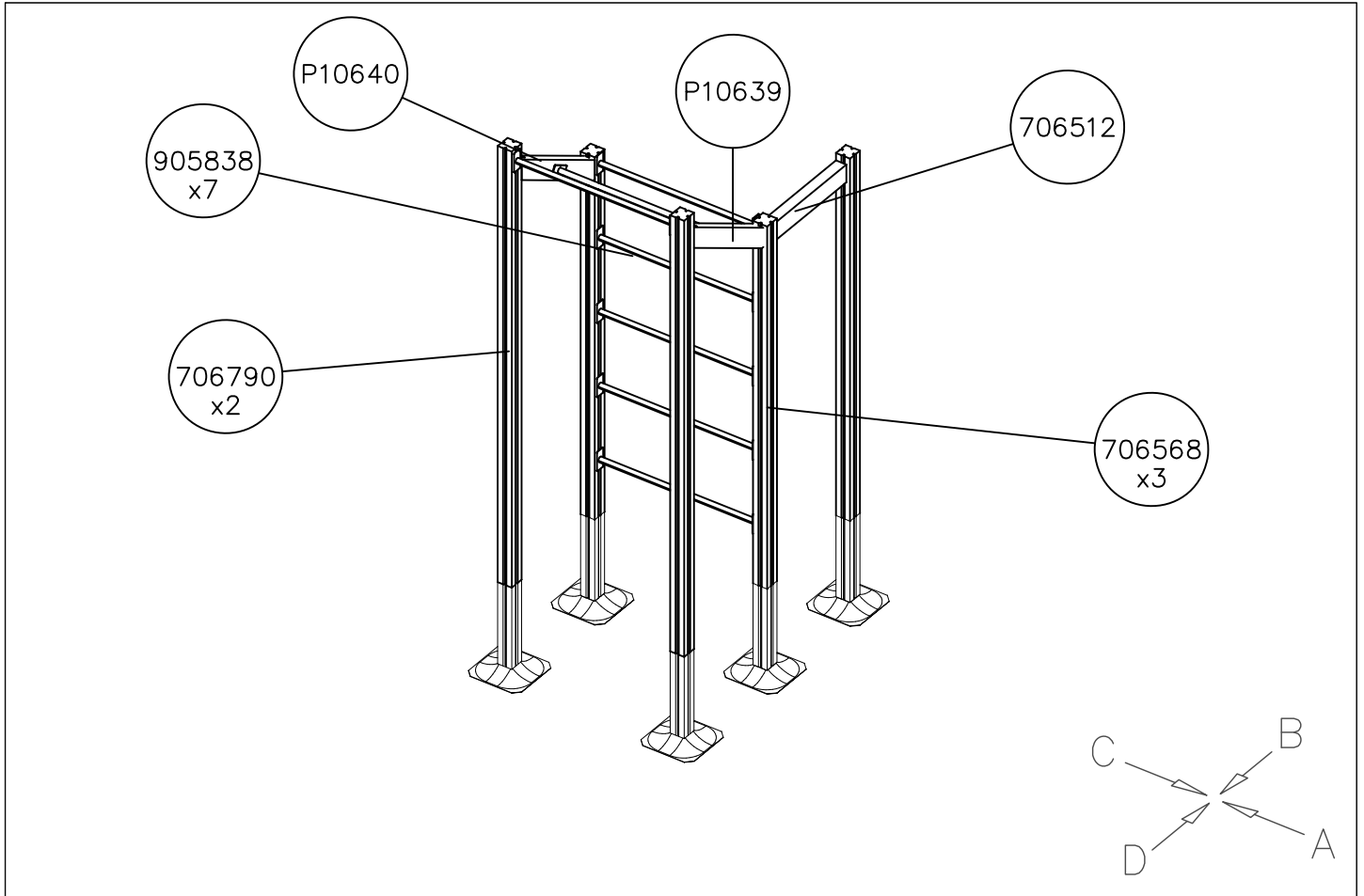

1:50

A

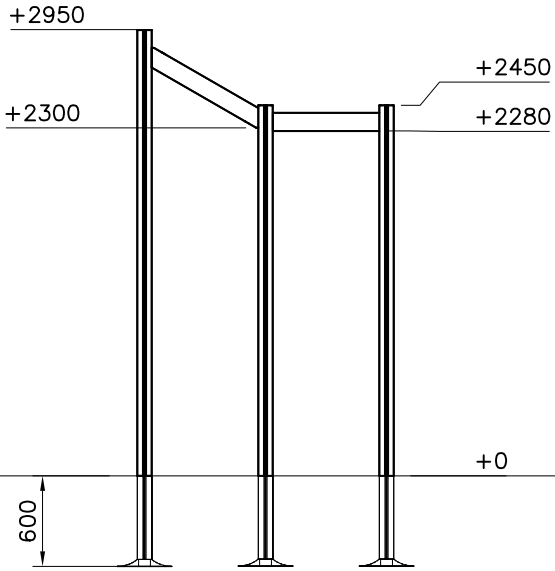

B

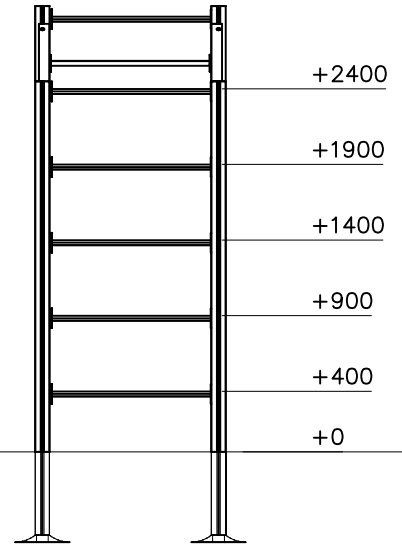

C

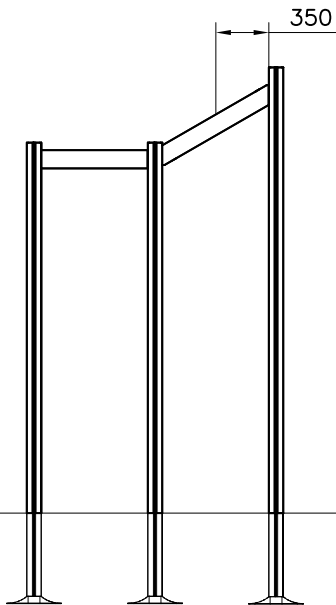

D

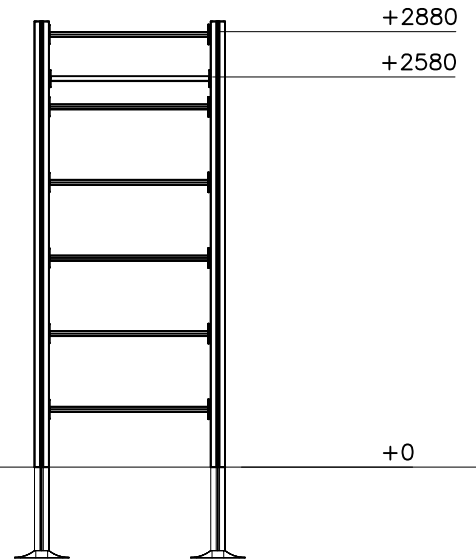

Max falling height

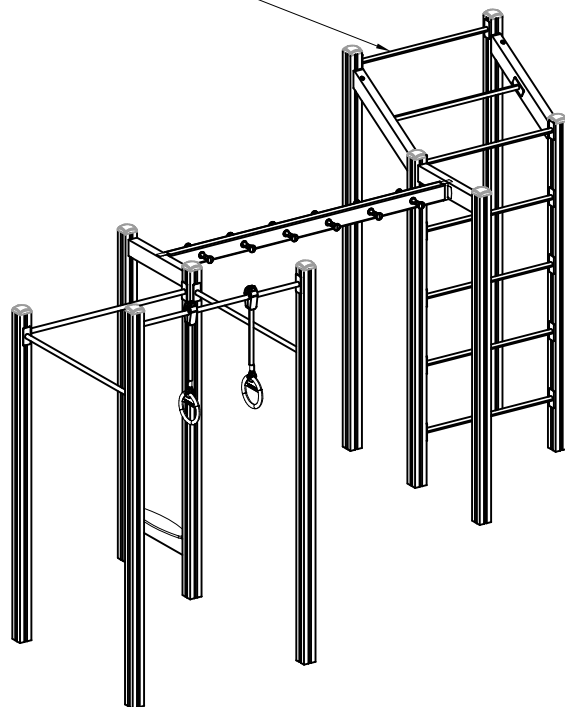

707290

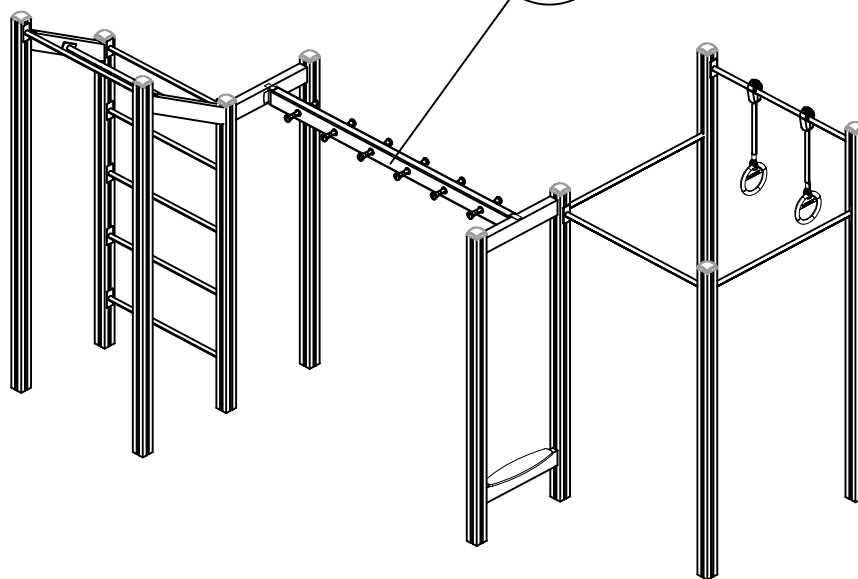



**Tuotekyltti tulee tuotteen mukana yhdellä seuraavista tavoista:**

**1) Metallinen tuotekyltti ja kiinnitysruuvit**

- Kiinnitä tuotekyltti ruuveilla tolppaan noin 2 metrin korkeuteen kuvan 1 mukaisesti.

**2) Tuotekylttitarra**

- Puhdista maalattu metalli- tai vaneripinta pölystä ja kosteudesta. Liimaa tarra kuvan 2 mukaisesti.
- Huom. Älä kiinnitä tarraa karheapintaiseen laminaattiin tai maalattuun puuhun.

**Vår produktmärkning levereras på ett av följande sätt:**

**1) Produktskylt i metall**

- Fäst skylten med de medföljande skruvarna

**2) Självhäftande produktetikett**

- Rengör den pulverlackerade metallytan eller laminatyten så att den blir fri från smuts och fukt. Fäst etiketten enligt fig. 2.
- Obs! Fäst ej etiketten på detaljer med skrovlig yta eller på målat trä.

**Product label is delivered by one of following ways:**

**1) Metal product label and screws**

- Fasten the label with screws.

**2) Label sticker**

- Clean the painted metal or plywood surface from dirt and moisture. Fasten the sticker as shown in the figure 2.
- Note. Do not attach the sticker to rough surfaced laminate or painted wood.

**La plaque d'informations produit est livrée sous l'une de ces 3 formes :**

**1) Plaque métallique et vis**

- Fixez la plaque à l'aide des vis.

**2) Etiquette autocollante**

- Avant de coller l'étiquette, nettoyez le composant métallique peint ou la plaque de contreplaqué, de toute saleté. La surface doit être sèche (voir image 2).
- Attention, ne pas coller l'étiquette sur une surface lamellé-collée irrégulière ou sur du bois peint.

**Die Auslieferung des Produktaufklebers erfolgt auf eine dieser Arten:**

**1) Produkt-Schild aus Metall incl. Schrauben**

- Die Befestigung des Schildes erfolgt mittels der Schrauben.

**2) Aufkleber**

- Entfernen Sie zunächst Schmutz und Feuchtigkeit vom lackierten Metall bzw. von der Holzoberfläche und bringen Sie den Aufkleber wie im Bild oben rechts beschrieben auf den gesäuberten Untergrund auf.
- Beachten Sie: Bringen Sie den Aufkleber nicht auf raues laminiertes oder lackiertes Holz an.