

LAPPSET®

FINNO







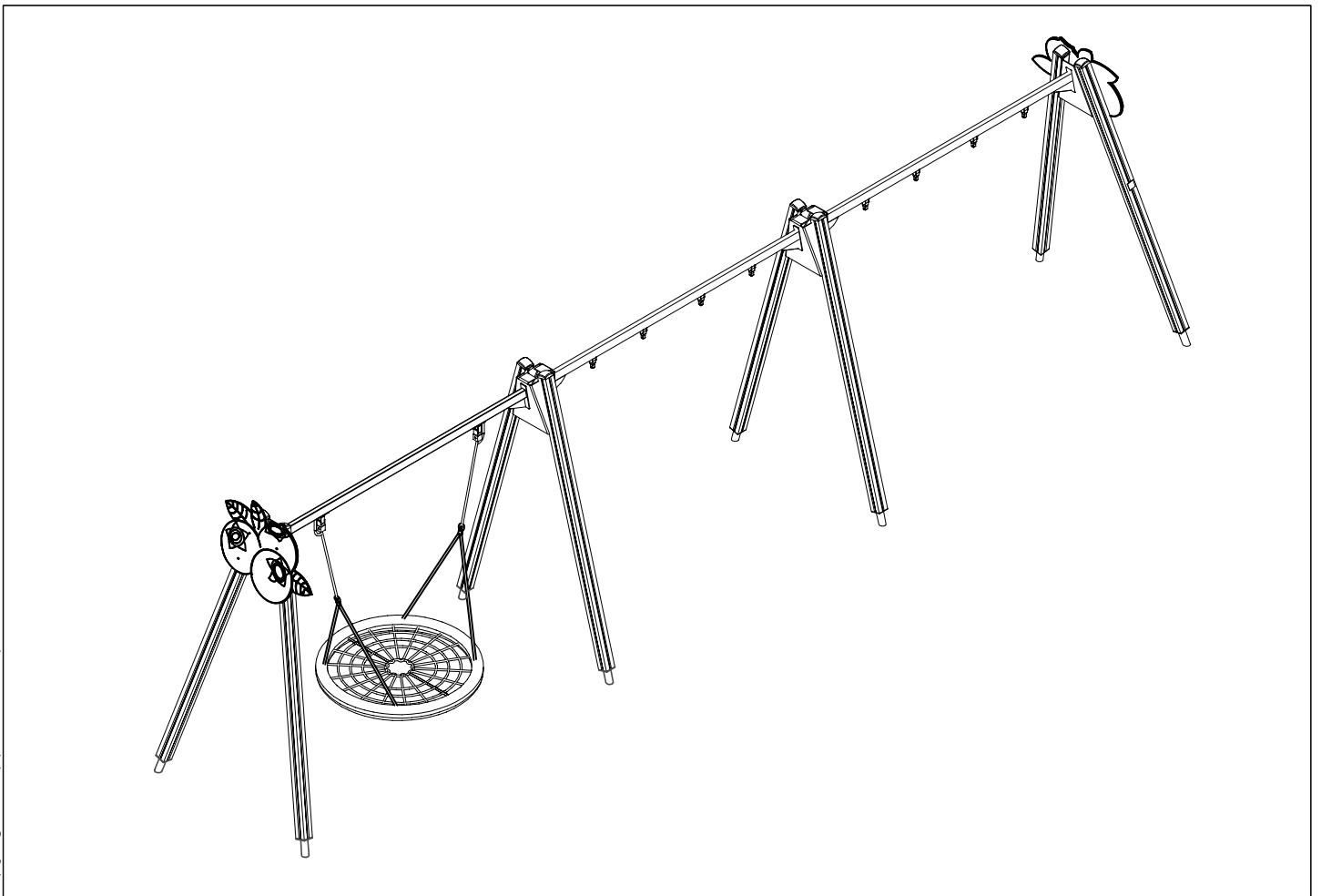







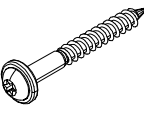

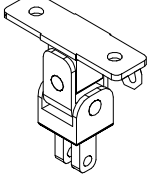



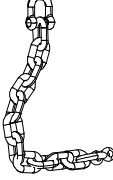
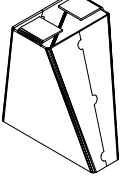

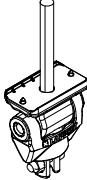
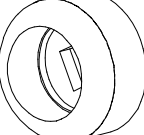
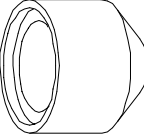
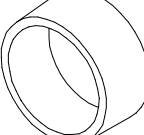

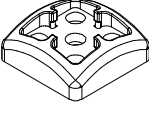
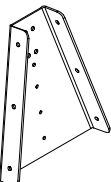
ASENNUSOHJE
MONTERINGSANSVISNING
INSTALLATION INSTRUCTION
AUFBAUANLEITUNG
NOTICE D'INSTALLATION

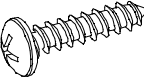
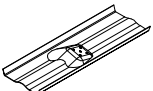
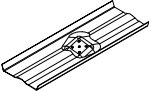
DATE: 25.7.2024

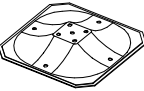
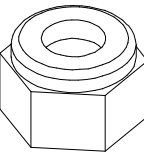
Q16030

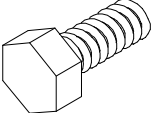
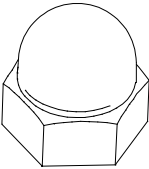
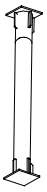
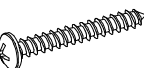
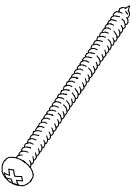

DATE: 25.7.2024

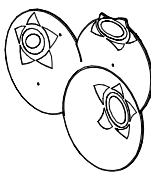
702286	PCS	702533	PCS	703248	PCS	706564	PCS	900240	PCS	900965	PCS
	1		1		1		8		8		12
65x65		118x78				L2650		Ø8x70		M10	
901958	PCS	901959	PCS	902234	PCS	903149	PCS	903577	PCS	904317	PCS
	2		1		4		12		2		2
		L2940		M12		M12x30					
904333	PCS	904904	PCS	905090	PCS	905104	PCS	905115	PCS	905138	PCS
	2		8		24		32		24		8
L2940				Ø45		M10		Ø30			
905196	PCS	905991	PCS	906499	PCS	909347	PCS	909506	PCS	909507	PCS
	8		2		4		24		4		2
				M12x110		M12x35		Ø3.5x13		L 1000	
909508	PCS	909511	PCS	909519	PCS	909637	PCS	909638	PCS	909639	PCS
	2		4		4		32		88		44
L 1000		L650		50x380x380		M10		Ø20/10.5		M10x25	
909644	PCS	911155	PCS	980114	PCS	980131	PCS	980154	PCS	999561	PCS
	12		4		4		32		56		1
M12		L650		Ø4x20		Ø6x60		Ø24x13		10g	
P15078	PCS	P15079	PCS		PCS		PCS		PCS		PCS
	2		2								

—— EN/AS Impact Area 67.1 m²
- - - - Falling Space 67.1 m²
Max Falling Height 1400 mm

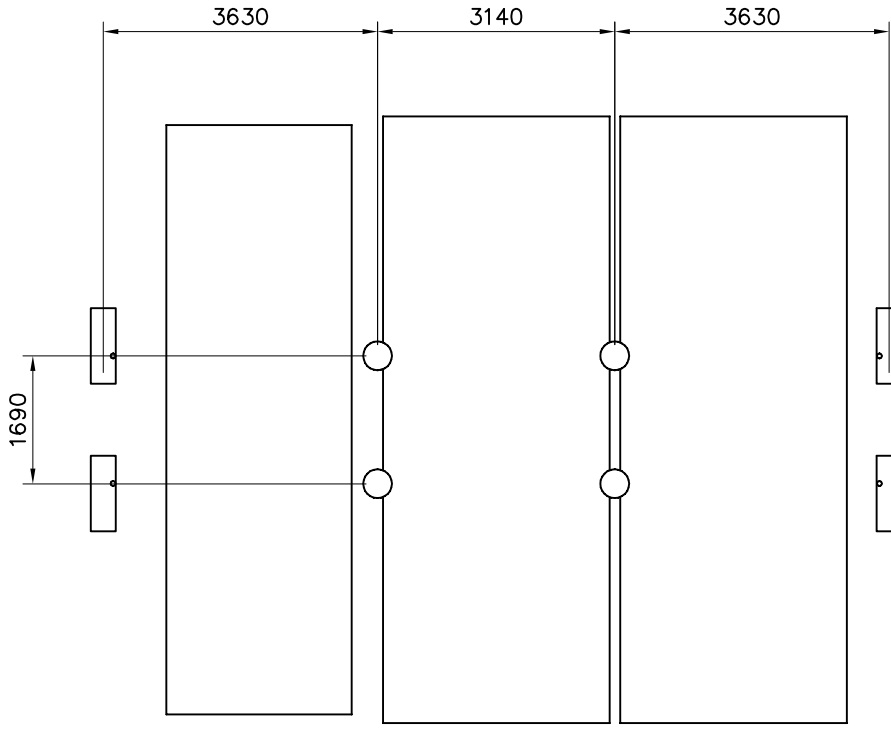
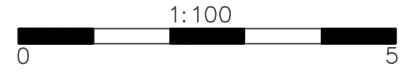

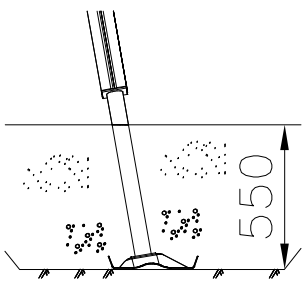
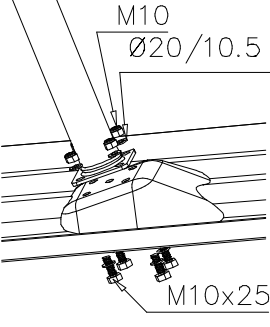
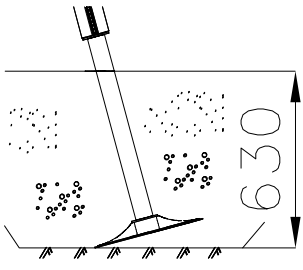
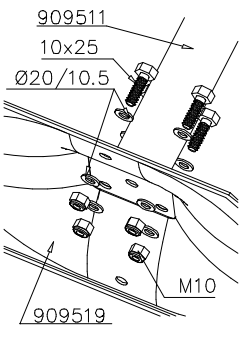

—— EN/AS Impact Area 67.1 m²
 - - - - Falling Space 67.1 m²
 Max Falling Height 1400 mm

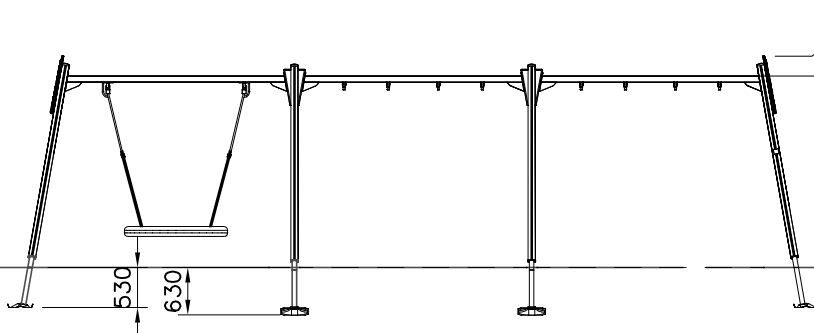
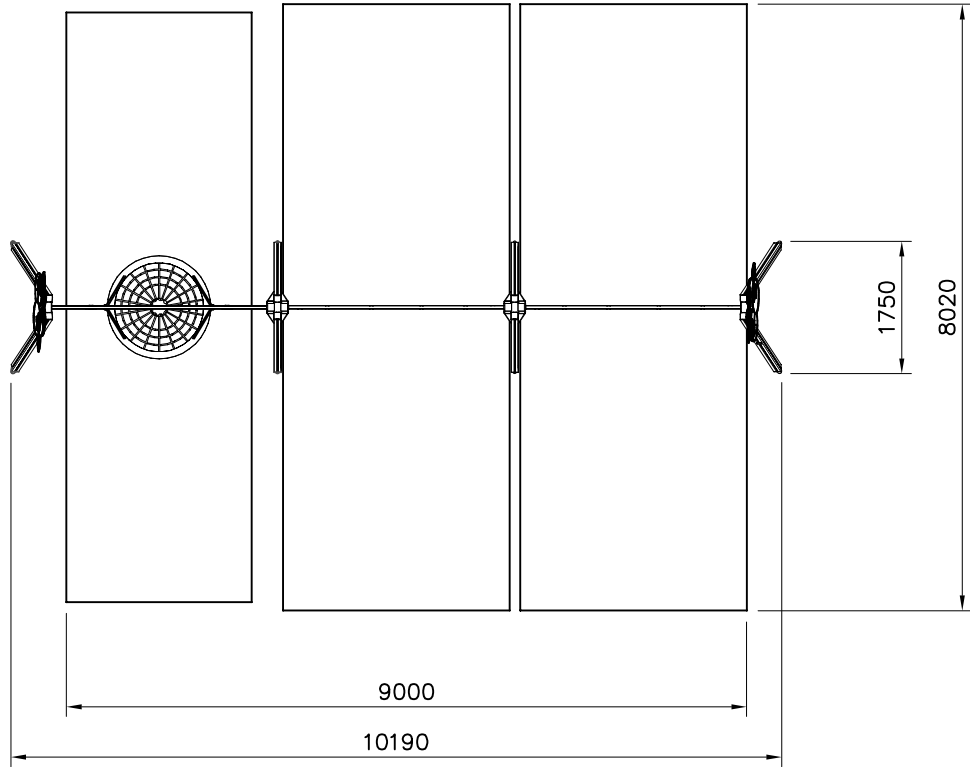

+2790
 +2530

+0

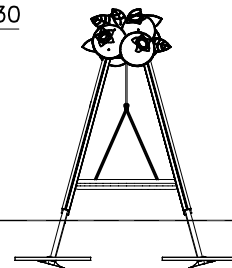

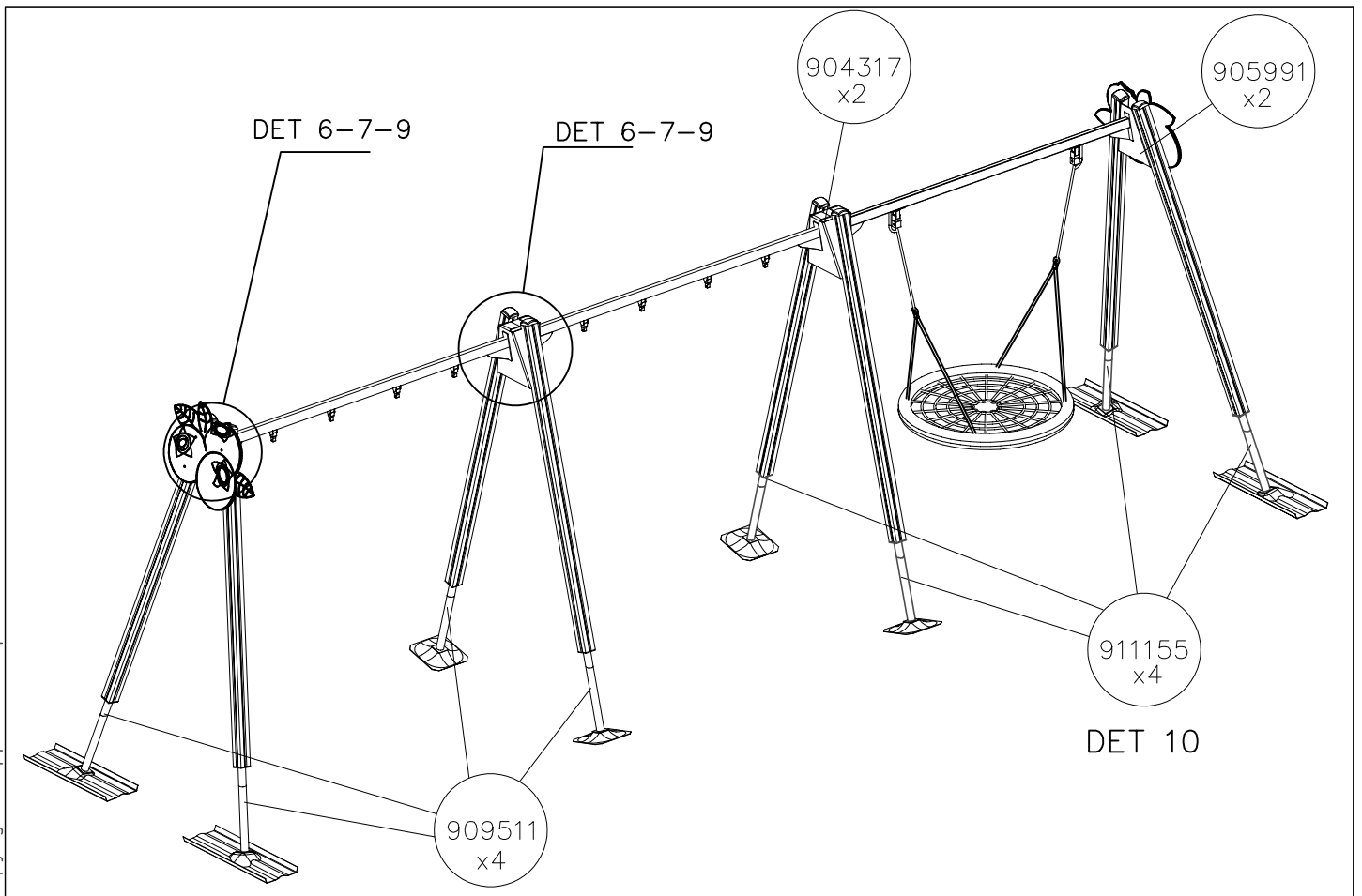
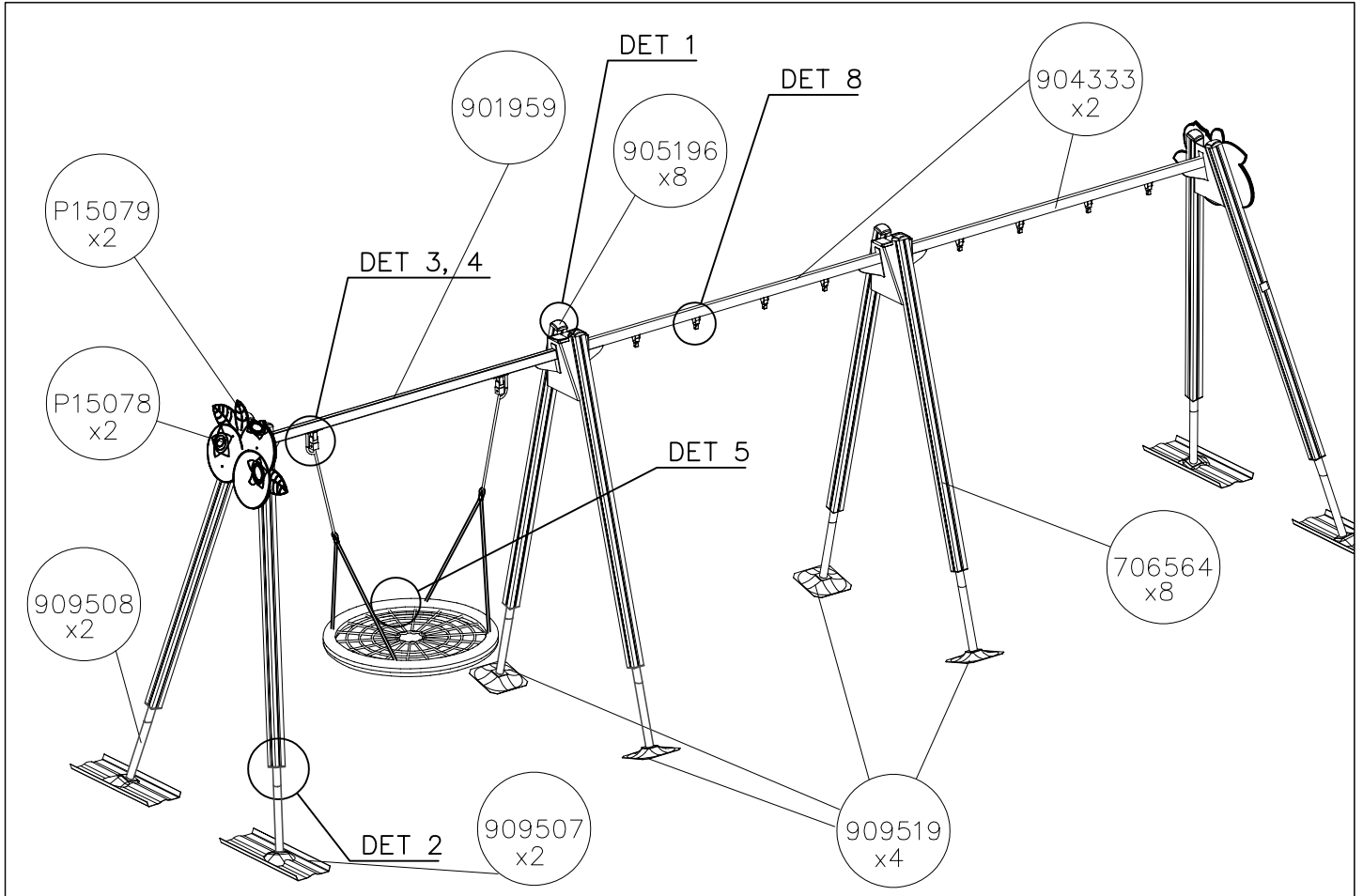

<p>DET 1</p> <p>6x60 980131</p>	<p>DET 2</p> <p>M10 905104 909521</p>	<p>DET 3</p> <p>901958 903577</p>	<p>DET 4</p> <p>M12x110 Ø24/13 901958 M8x35 Ø24/13 M12 M8 CUT EXTRA CHAIN</p>
<p>DET 5</p> <p>>400</p>	<p>DET 6</p> <p>M12 → 80 Nm Ø24/13 M12 M12x30 M10x25 Ø20/10.5 M10 M10 → 45 Nm 904317</p>	<p>DET 7</p> <p>904317</p>	<p>DET 8</p> <p>M12 980154 Ø24/13 904904</p>
<p>DET 9</p> <p>999561 GLUE Ø24/13 12x35 905115 905090</p>	<p>DET 10</p> <p>91155</p>		

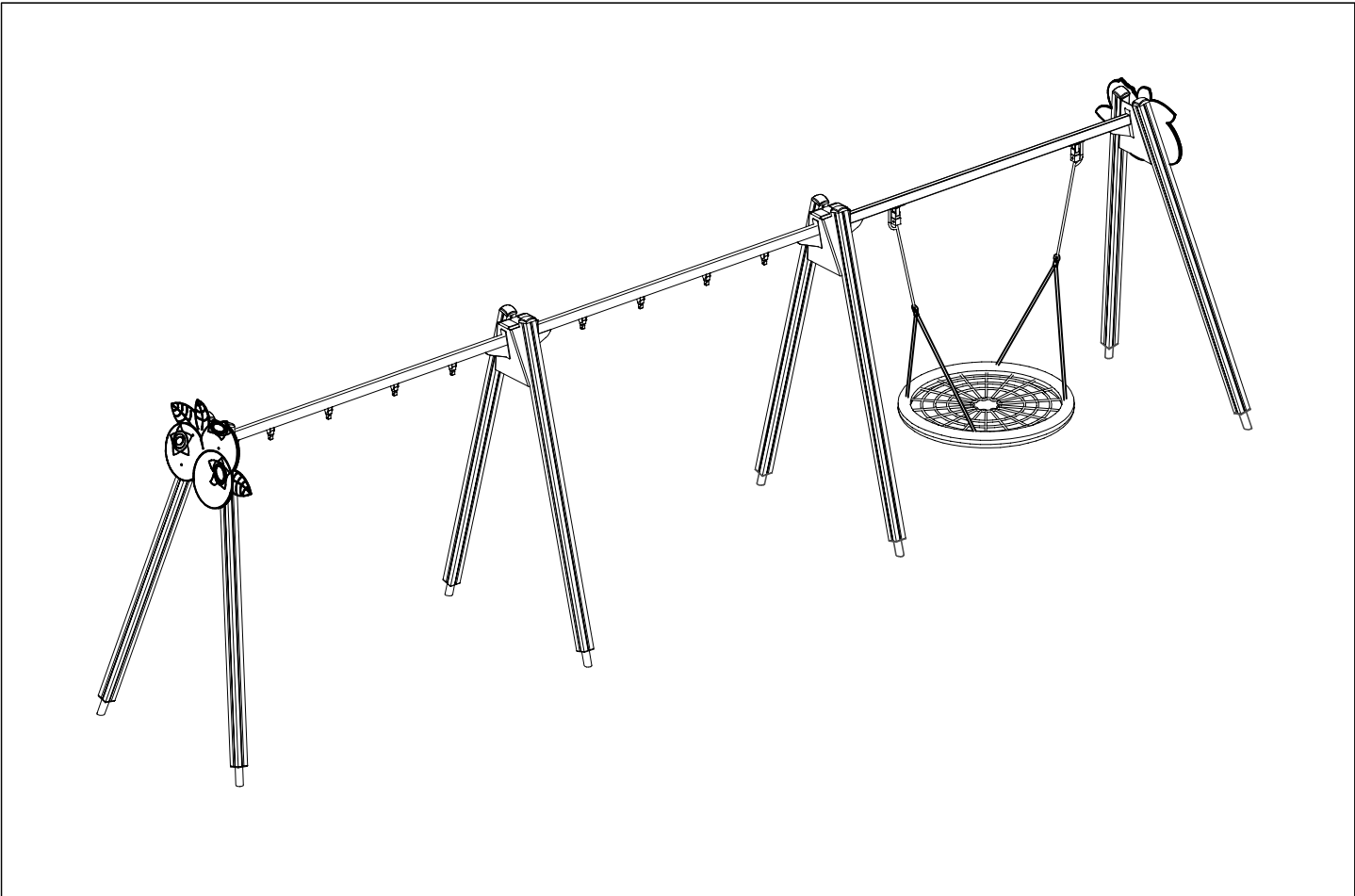

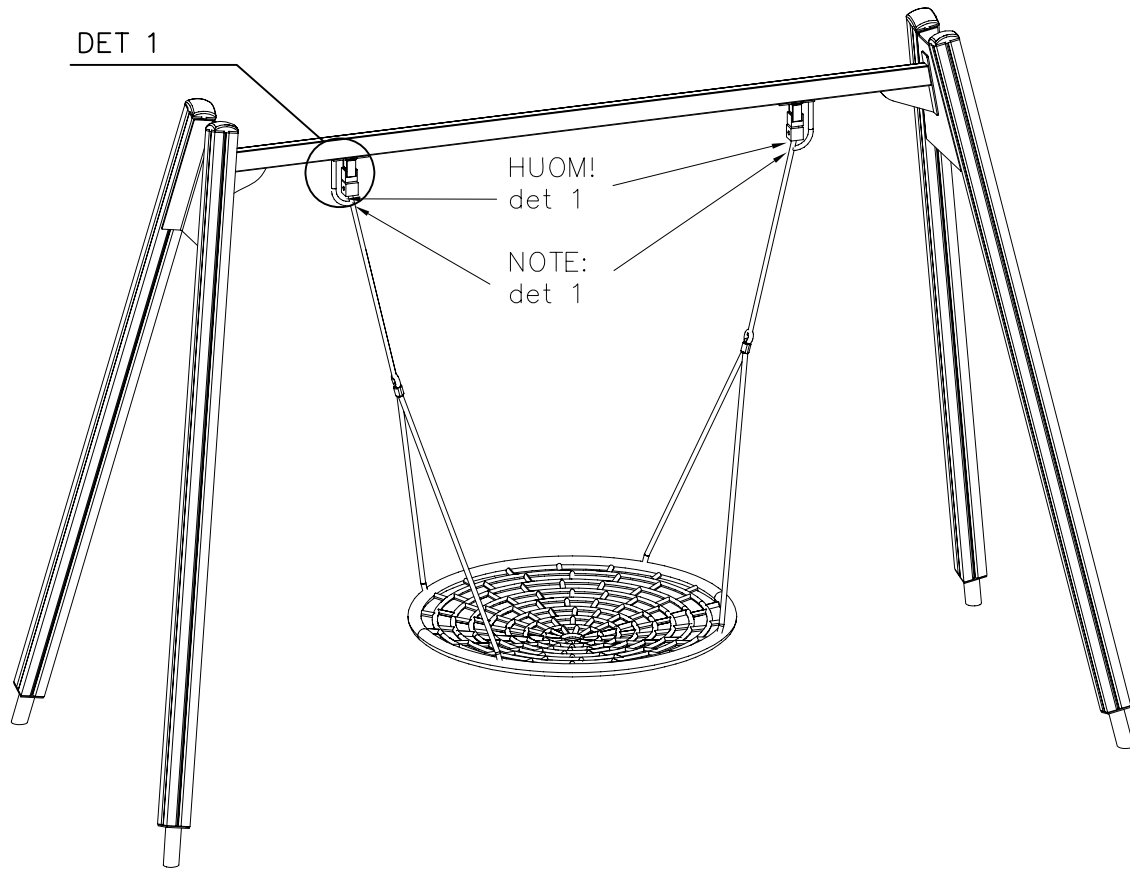

DET 1

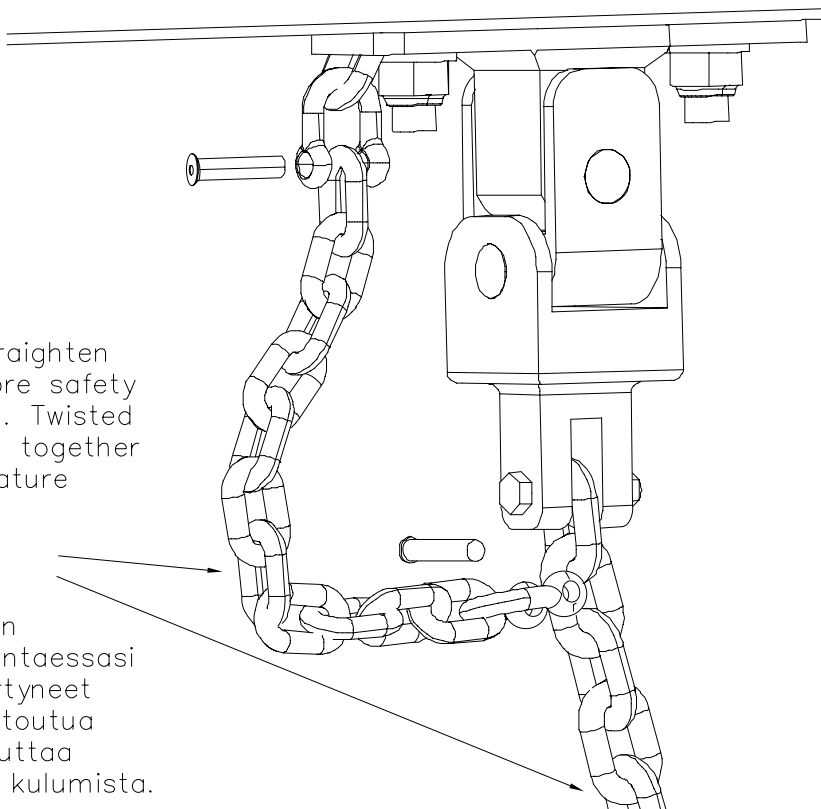

LAPPSET®
BETON FOUNDATION

FOOT

DATE: 27.10.2015

1(1)

② 905104	PCS		PCS
	4		
 M10	PCS		PCS



905104



Tuotekyltti tulee tuotteen mukana yhdellä seuraavista tavoista:

1) Metallinen tuotekyltti ja kiinnitysruuvit

- Kiinnitä tuotekyltti ruuveilla tolppaan noin 2 metrin korkeuteen kuvan 1 mukaisesti.

2) Tuotekyltitarra

- Puhdista maalattu metalli- tai vaneripinta pölystä ja kosteudesta. Liimaa tarra kuvan 2 mukaisesti.
- Huom. Älä kiinnitä tarraa karheapintaiseen laminaattiin tai maalattuun puuhun.

Vår produktmärkning levereras på ett av följande sätt:

1) Produktskylt i metall

- Fäst skylten med de medföljande skruvarna

2) Självhäftande produktetikett

- Rengör den pulverlackerade metallytan eller laminatyten så att den blir fri från smuts och fukt. Fäst etiketten enligt fig. 2.
- Obs! Fäst ej etiketten på detaljer med skrovlig yta eller på målat trä.

Product label is delivered by one of following ways:

1) Metal product label and screws

- Fasten the label with screws.

2) Label sticker

- Clean the painted metal or plywood surface from dirt and moisture. Fasten the sticker as shown in the figure 2.
- Note. Do not attach the sticker to rough surfaced laminate or painted wood.

La plaque d'informations produit est livrée sous l'une de ces 3 formes :

1) Plaque métallique et vis

- Fixez la plaque à l'aide des vis.

2) Etiquette autocollante

- Avant de coller l'étiquette, nettoyez le composant métallique peint ou la plaque de contreplaqué, de toute saleté. La surface doit être sèche (voir image 2).
- Attention, ne pas coller l'étiquette sur une surface lamellé-collée irrégulière ou sur du bois peint.

Die Auslieferung des Produktaufklebers erfolgt auf eine dieser Arten:

1) Produkt-Schild aus Metall incl. Schrauben

- Die Befestigung des Schildes erfolgt mittels der Schrauben.

2) Aufkleber

- Entfernen Sie zunächst Schmutz und Feuchtigkeit vom lackierten Metall bzw. von der Holzoberfläche und bringen Sie den Aufkleber wie im Bild oben rechts beschrieben auf den gesäuberten Untergrund auf.
- Beachten Sie: Bringen Sie den Aufkleber nicht auf raues laminiertes oder lackiertes Holz an.