

# LAPPSET®

## FINNO





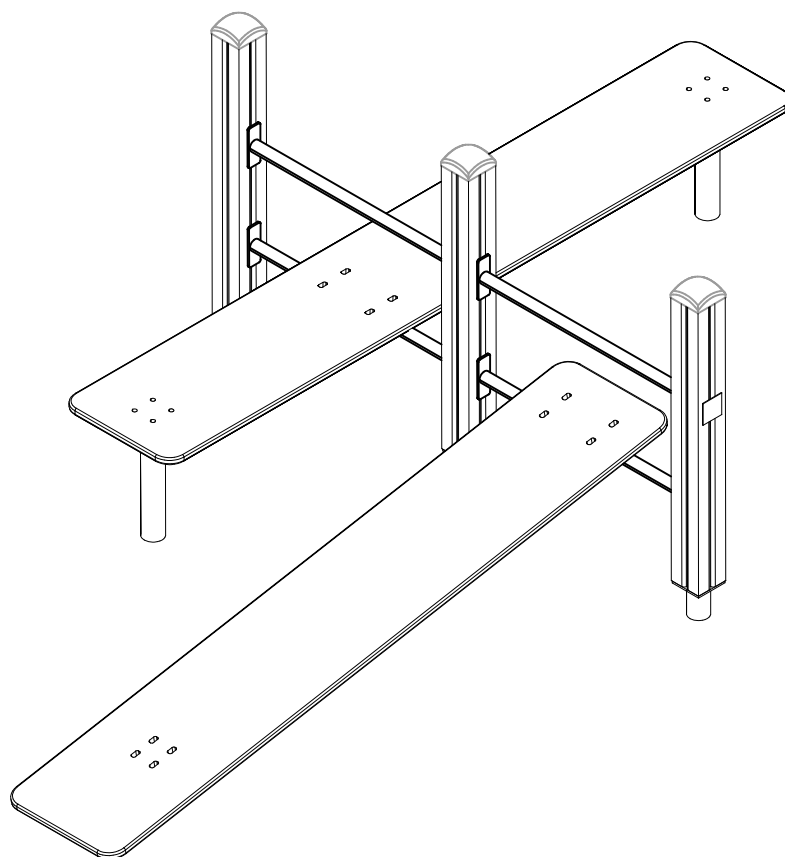

ASENNUSOHJE  
MONTERINGSANSVISNING  
INSTALLATION INSTRUCTION  
AUFBAUANLEITUNG  
NOTICE D'INSTALLATION

DATE: 27.10.2021

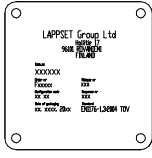
### Q12451-3

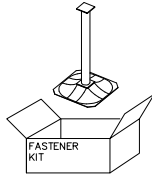
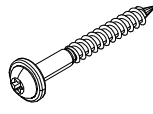
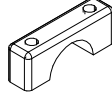
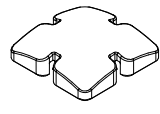
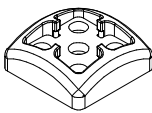
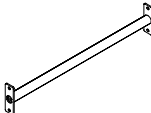
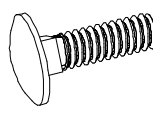

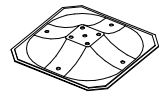
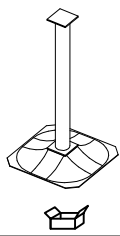
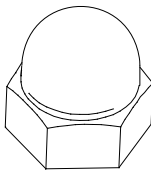
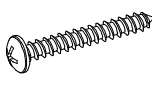
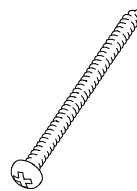
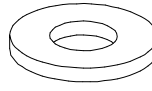
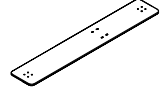
DATE: 27.10.2021

702286  65x65	PCS 1	706499-604  93x93x860	PCS 3	706531  FASTENER KIT	PCS 3	900240  Ø8x70	PCS 16	902454 	PCS 4	905138  GRAY	PCS 3
905196  GRAY	PCS 3	907694-215  L 704	PCS 4	909107  M12x80	PCS 8	909109  M12x40	PCS 12	909511  90x90x650	PCS 3	909519  50x380x380	PCS 3
909521  P01986	PCS 3	909644  M12	PCS 20	980114  Ø4x20	PCS 4	980131  Ø6x60	PCS 12	980154  Ø24/13	PCS 68	P01986  2200x380	PCS 1
P01987  2000x380	PCS 1		PCS		PCS		PCS		PCS		PCS
	PCS		PCS		PCS		PCS		PCS		PCS
	PCS		PCS		PCS		PCS		PCS		PCS
	PCS		PCS		PCS		PCS		PCS		PCS

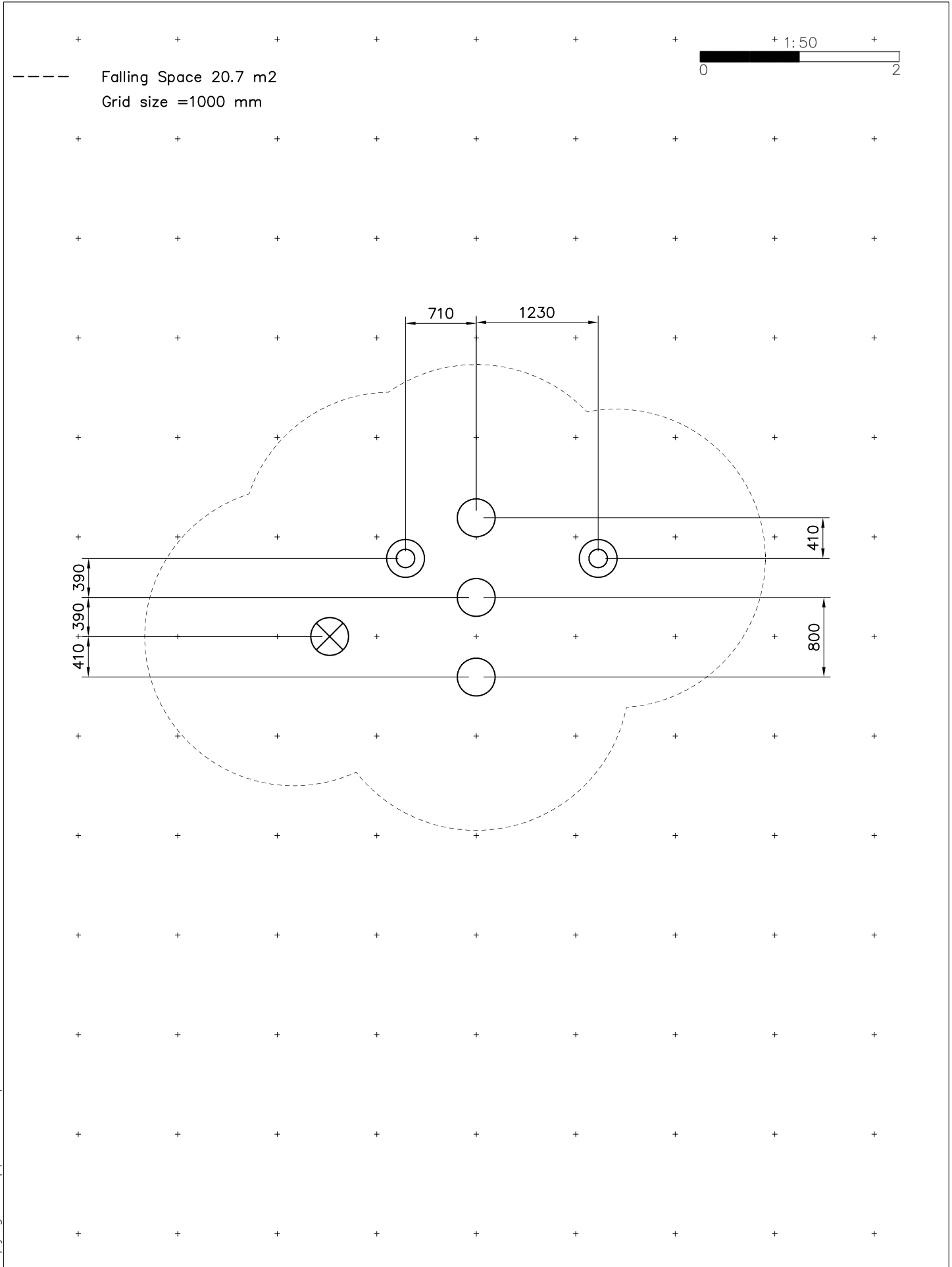

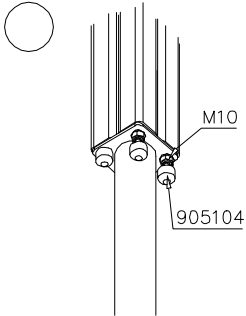
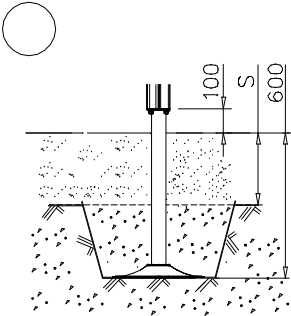
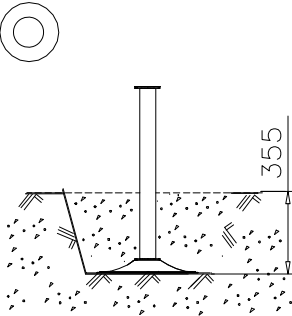
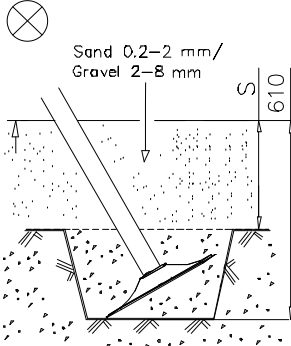

----- Falling Space 20.7 m<sup>2</sup>  
Max Falling Height 450 mm

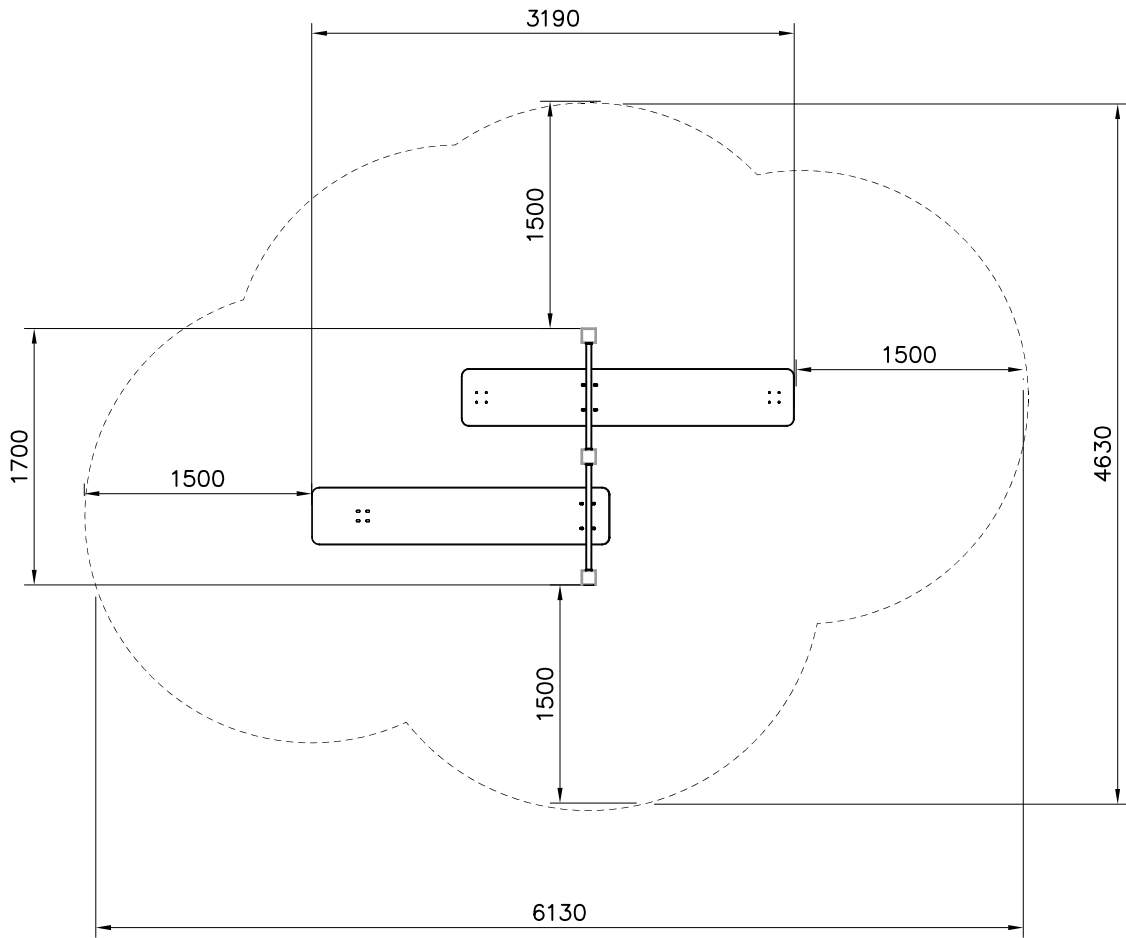
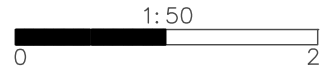

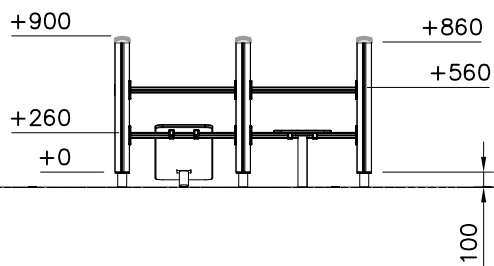
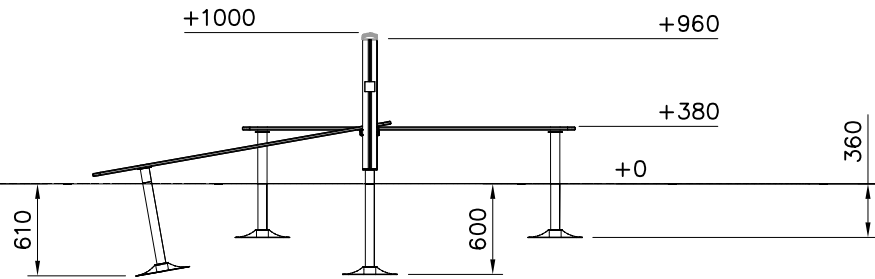

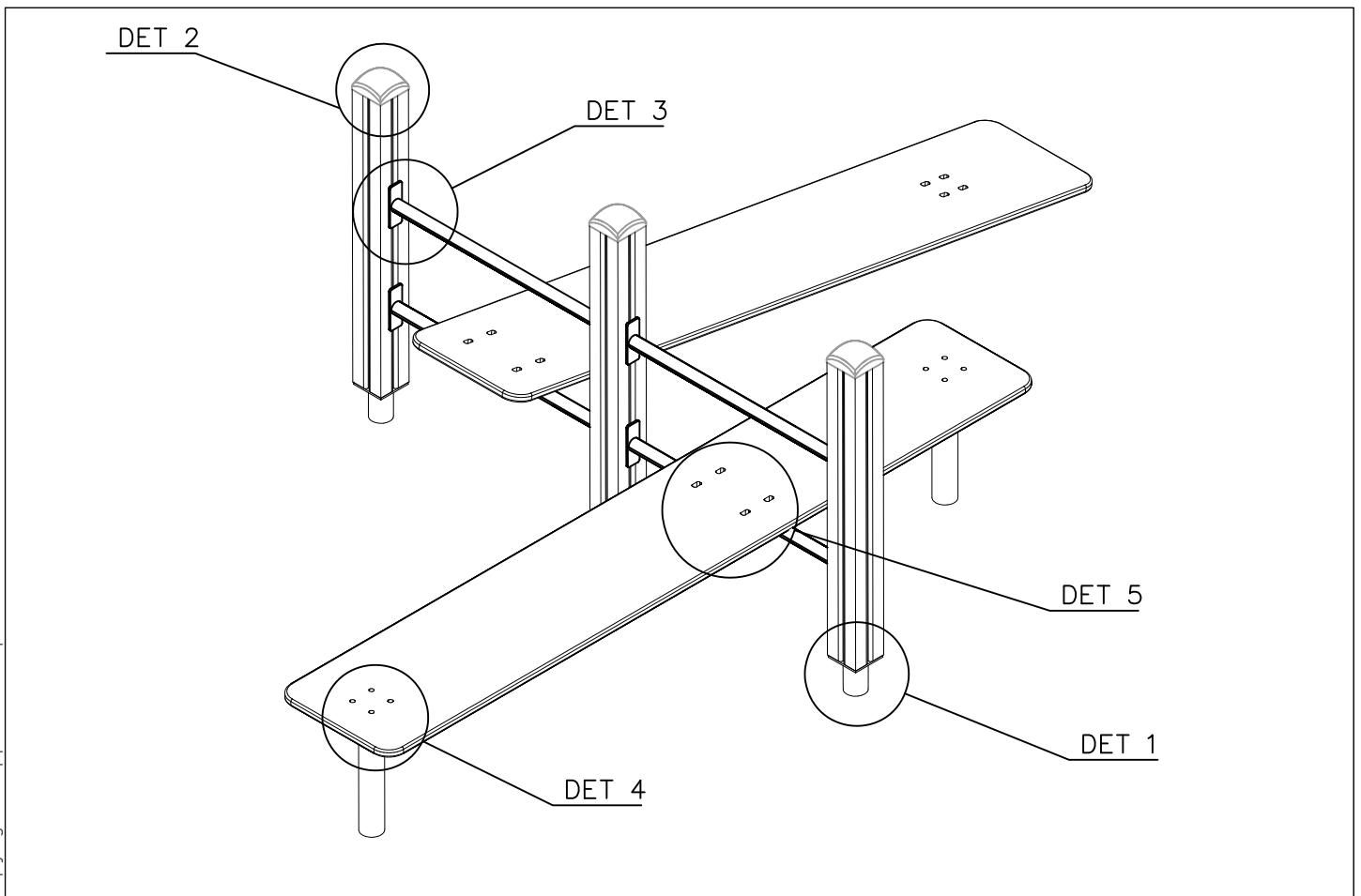
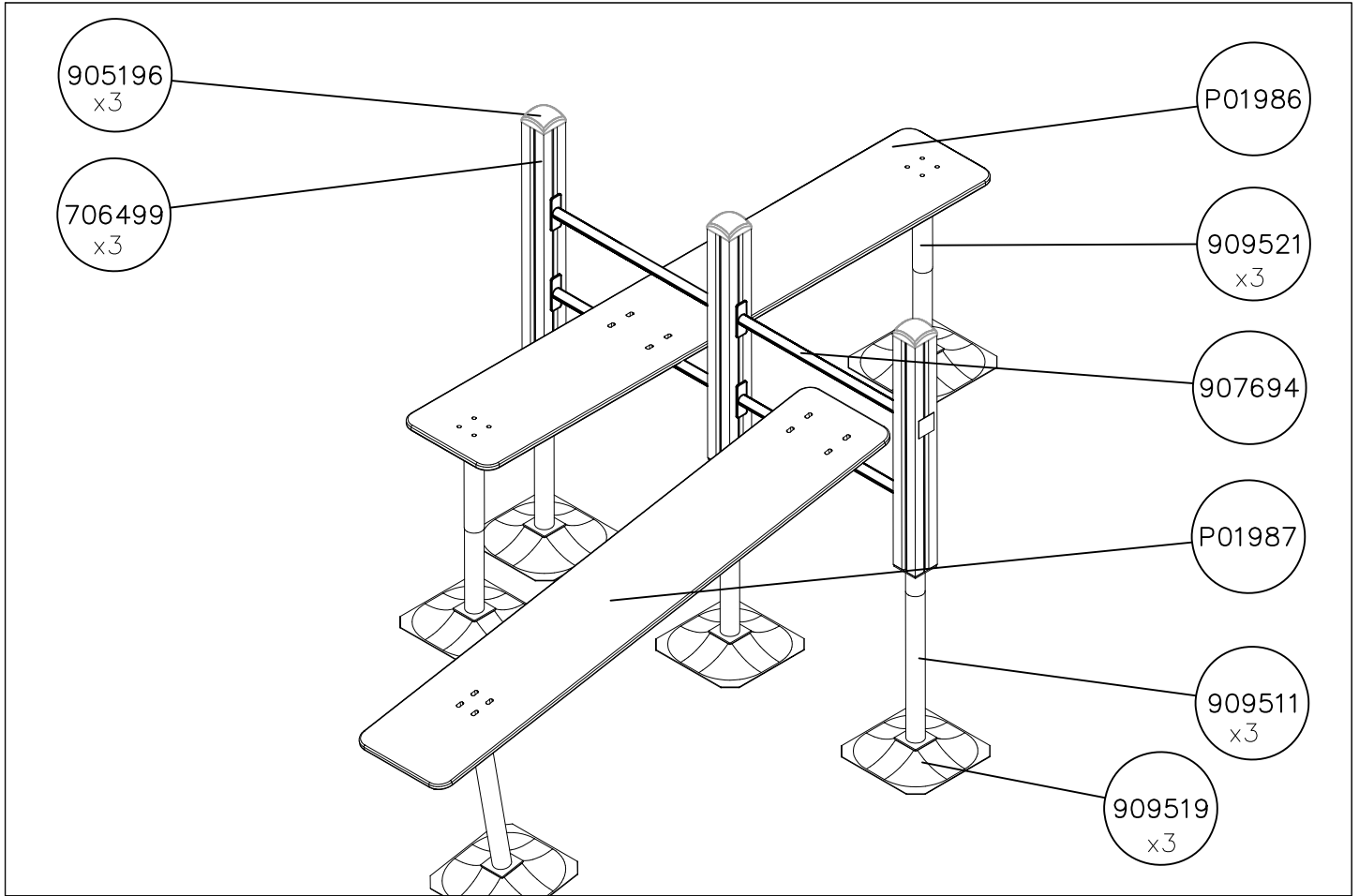

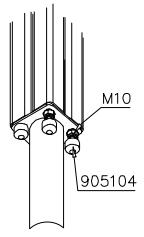
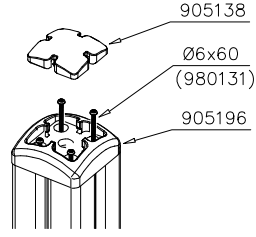
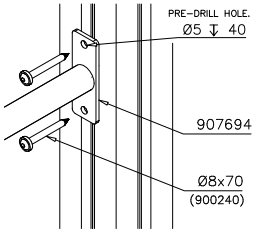
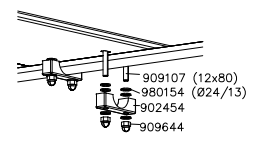
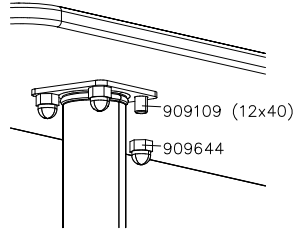

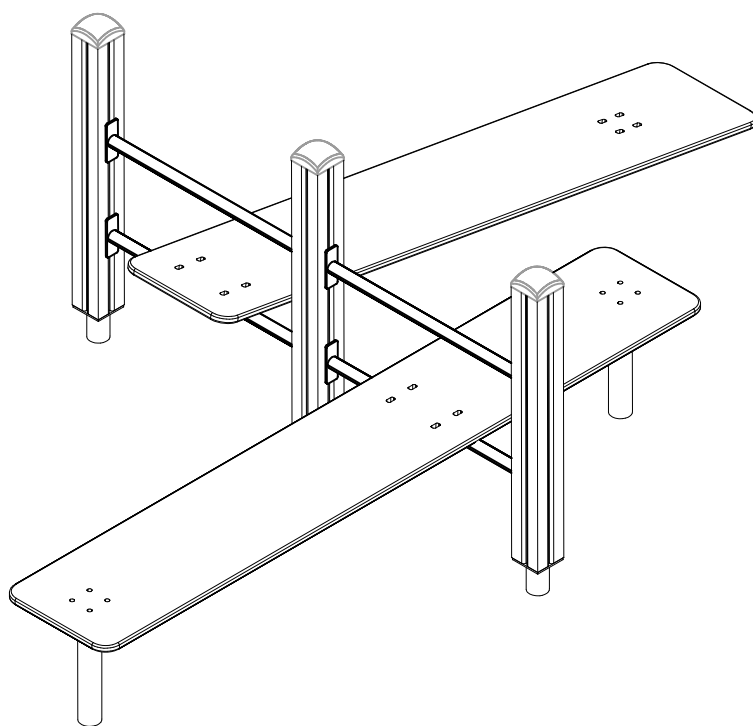
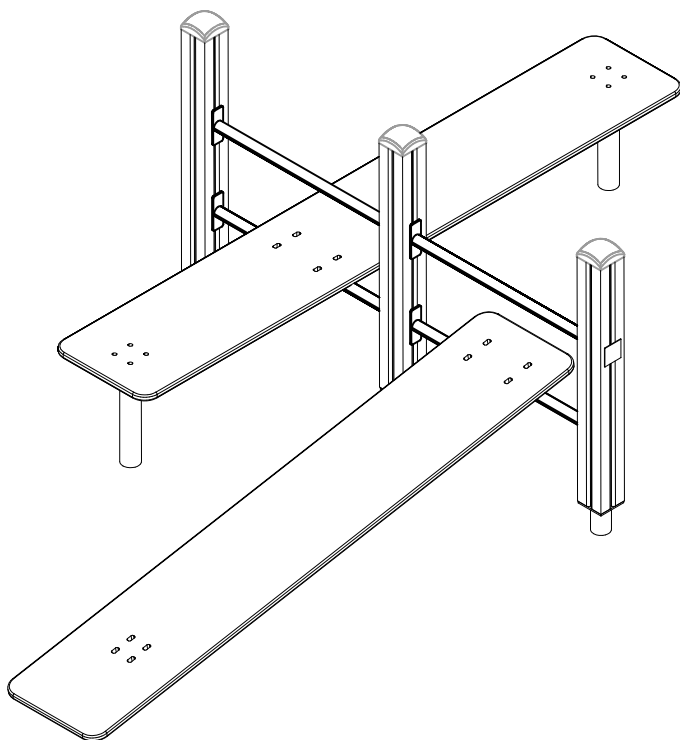

<p>DET 1</p> 	<p>DET 2</p> 	<p>DET 3</p> 	<p>DET 4</p> 
<p>DET 5</p> 			

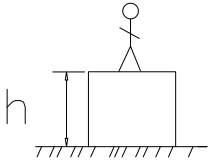



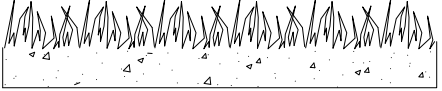
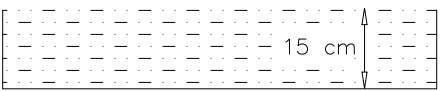
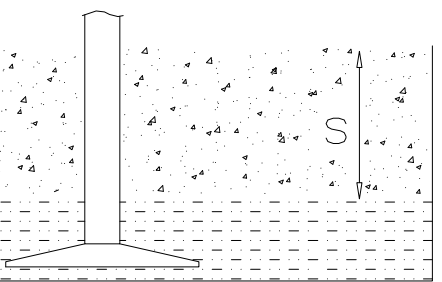
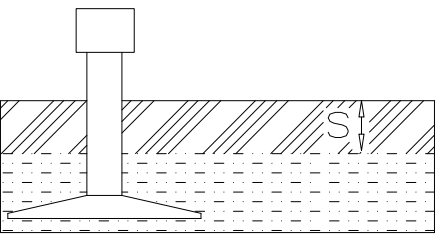

												
<p><b><math>h &lt; 600</math></b></p> <p>Without movement and therefore without Impact Area</p>	<p>Totally hard surfaces.</p> <p>Note. Lappset does <u>not recommend</u> totally hard surfaces at all.</p>	<p>E.g. concrete or asphalt</p> 										
<p><b><math>h &lt; 600</math></b></p> <p>With movement e.g. rocking</p>	<p>Materials with very limited impact attenuating properties.</p>	<p>E.g. wood</p> 										
<p><b><math>h &lt; 1000</math></b></p>	<p>Materials with significant impact attenuating properties.</p>	<p>fine gravel 0–8 mm</p>  <p>grass</p>  <p>unsorted sand</p> 										
<p><b><math>h &lt; 3000</math></b></p>	<p>Loose fill material</p> <p>E.g. sand/gravel 0,25...8 mm D60/D10&lt;3,0 Woodchips 5...30 mm bark 20...80 mm</p>	 <table data-bbox="1024 1691 1332 1792"> <tr> <td><math>\underline{S}</math></td> <td><math>\underline{h}</math></td> </tr> <tr> <td>30 cm</td> <td>&lt; 2,0 m</td> </tr> <tr> <td>40 cm</td> <td>&lt; 3,0 m</td> </tr> </table>	$\underline{S}$	$\underline{h}$	30 cm	< 2,0 m	40 cm	< 3,0 m				
$\underline{S}$	$\underline{h}$											
30 cm	< 2,0 m											
40 cm	< 3,0 m											
	<p>Syntethic granulates</p> <table data-bbox="406 1892 758 2060"> <tr> <td><math>\underline{S}</math></td> <td><math>\underline{h}</math></td> </tr> <tr> <td>40 mm</td> <td>~&gt; 1,2...1,3 m</td> </tr> <tr> <td>50 mm</td> <td>~&gt; 1,5...1,7 m</td> </tr> <tr> <td>60 mm</td> <td>~&gt; 1,8...2,0 m</td> </tr> <tr> <td>70 mm</td> <td>~&gt; 2,1...2,5 m</td> </tr> </table> <p>Note. For accurate values, see manufacturer's instructions.</p>	$\underline{S}$	$\underline{h}$	40 mm	~> 1,2...1,3 m	50 mm	~> 1,5...1,7 m	60 mm	~> 1,8...2,0 m	70 mm	~> 2,1...2,5 m	
$\underline{S}$	$\underline{h}$											
40 mm	~> 1,2...1,3 m											
50 mm	~> 1,5...1,7 m											
60 mm	~> 1,8...2,0 m											
70 mm	~> 2,1...2,5 m											

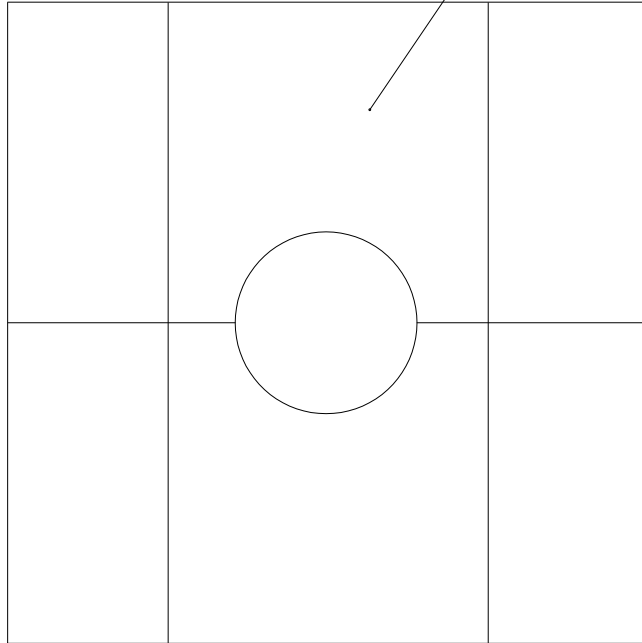
REMOVE SAFETY SURFACE/SAND/GRAVEL  
TO CHECK FOUNDATION



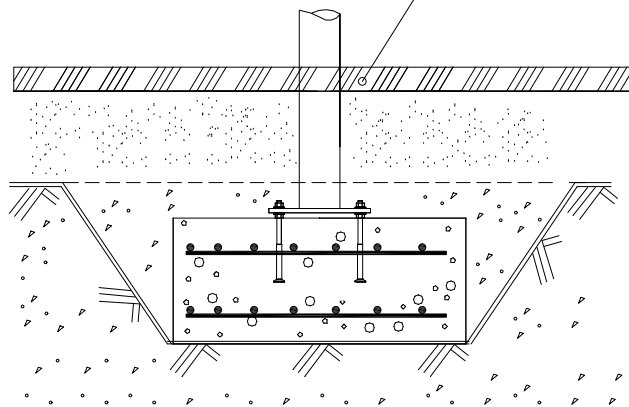

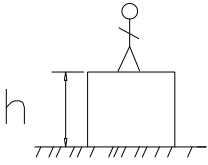

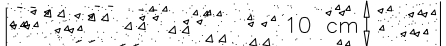
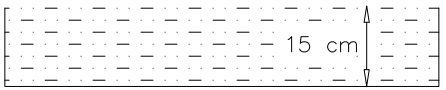
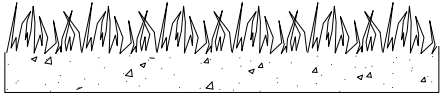
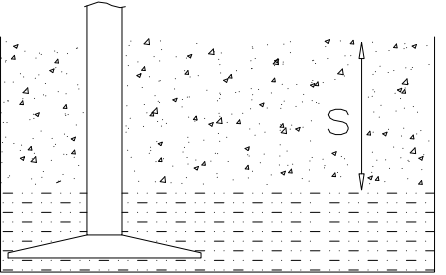
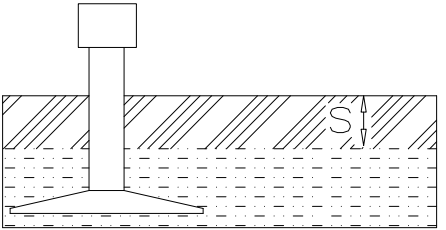
REMOVE SAFETY SURFACE/SAND/GRAVEL  
TO CHECK FOUNDATION

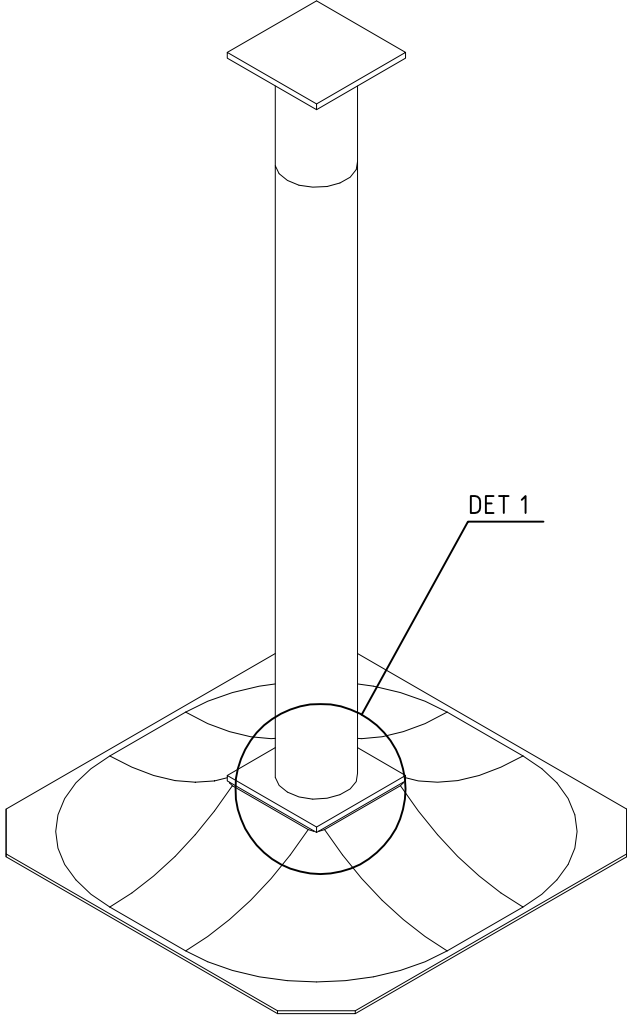

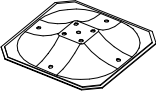
		
<p><b>h &lt; 1000</b></p>	<p>Totally hard surfaces or materials with very limited impact attenuating properties.</p> <p>Case by case risk assessment is needed including e.g. evaluation whether there is forced movement, what is the intended exercise and where will the product be installed.</p>	<p>Totally hard surfaces. E.g. concrete or asphalt</p>  <p>Materials with very limited impact attenuating properties. E.g. wood</p> 
<p><b>h &lt; 1200</b></p>	<p>Materials with significant impact attenuating properties.</p>	<p>fine gravel 0–8 mm</p>  <p>Unsorted sand/ topsoil</p> 
<p><b>h &lt; 1500</b></p>	<p>Lawn</p> 	
<p><b>h &lt; 3000</b></p>	<p>Loose fill material</p> <p>E.g. sand/gravel 0,25...8 mm D60/D10&lt;3,0 Woodchips 5...30 mm bark 20...80 mm</p>	 <p><u>S</u>                      <u>h</u> 30 cm                      &lt; 2,0 m 40 cm                      &lt; 3,0 m</p>
<p>Syntetic granulates</p> <p><u>S</u>                      <u>h</u> 40 mm                      ~ &gt; 1,2...1,3 m 50 mm                      ~ &gt; 1,5...1,7 m 60 mm                      ~ &gt; 1,8...2,0 m 70 mm                      ~ &gt; 2,1...2,5 m</p> <p>Note. For accurate values, see manufacturer's instructions.</p>		



①	909511	PCS	②	909519	PCS
		1			1
③	909637	PCS	④	909638	PCS
		4			8
	M10			Ø20/10.5	
⑤	909639	PCS			PCS
		4			
	M10x25				
		PCS			PCS
		PCS			PCS
		PCS			PCS
		PCS			PCS
		PCS			PCS

DET 1

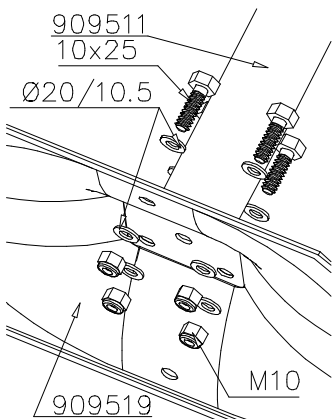

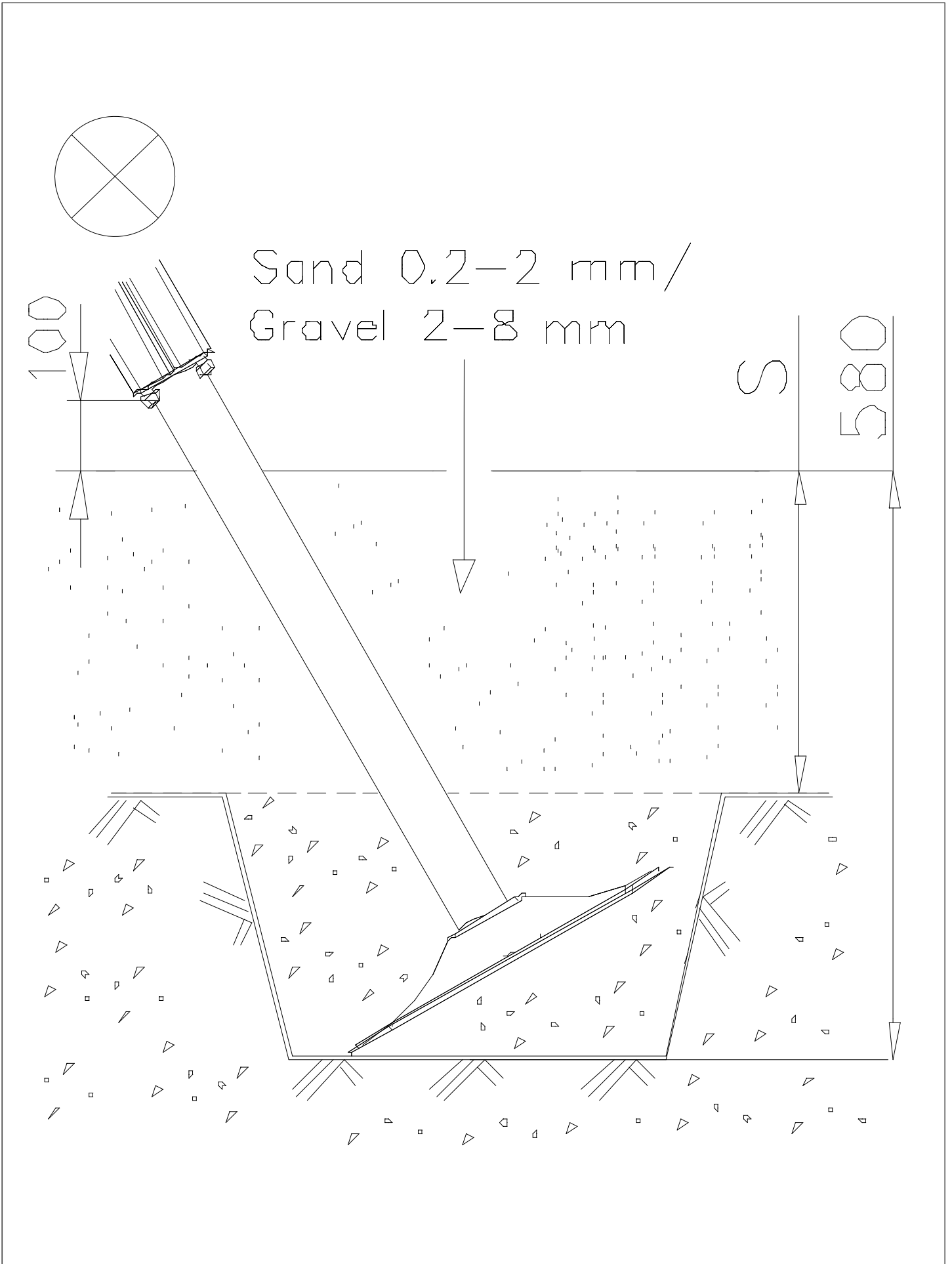

**Tuotekyltti tulee tuotteen mukana yhdellä seuraavista tavoista:****1) Metallinen tuotekyltti ja kiinnitysruuvit**

- Kiinnitä tuotekyltti ruuveilla tolppaan noin 2 metrin korkeuteen kuvan 1 mukaisesti.

**2) Tuotekylttitarra**

- Puhdista maalattu metalli- tai vaneripinta pölystä ja kosteudesta. Liimaa tarra kuvan 2 mukaisesti.
- Huom. Älä kiinnitä tarraa karheapintaiseen laminaattiin tai maalattuun puuhun.

**Vår produktmärkning levereras på ett av följande sätt:****1) Produktskylt i metall**

- Fäst skylten med de medföljande skruvarna

**2) Självhäftande produktetikett**

- Rengör den pulverlackerade metallytan eller laminatyten så att den blir fri från smuts och fukt. Fäst etiketten enligt fig. 2.
- Obs! Fäst ej etiketten på detaljer med skrovlig yta eller på målat trä.

**Product label is delivered by one of following ways:****1) Metal product label and screws**

- Fasten the label with screws.

**2) Label sticker**

- Clean the painted metal or plywood surface from dirt and moisture. Fasten the sticker as shown in the figure 2.
- Note. Do not attach the sticker to rough surfaced laminate or painted wood.

**La plaque d'informations produit est livrée sous l'une de ces 3 formes :****1) Plaque métallique et vis**

- Fixez la plaque à l'aide des vis.

**2) Etiquette autocollante**

- Avant de coller l'étiquette, nettoyez le composant métallique peint ou la plaque de contreplaqué, de toute saleté. La surface doit être sèche (voir image 2).
- Attention, ne pas coller l'étiquette sur une surface lamellé-collée irrégulière ou sur du bois peint.

**Die Auslieferung des Produktaufklebers erfolgt auf eine dieser Arten:****1) Produkt-Schild aus Metall incl. Schrauben**

- Die Befestigung des Schildes erfolgt mittels der Schrauben.

**2) Aufkleber**

- Entfernen Sie zunächst Schmutz und Feuchtigkeit vom lackierten Metall bzw. von der Holzoberfläche und bringen Sie den Aufkleber wie im Bild oben rechts beschrieben auf den gesäuberten Untergrund auf.
- Beachten Sie: Bringen Sie den Aufkleber nicht auf raues laminiertes oder lackiertes Holz an.

**LAPPSET®**  
**DEEP FOUNDATION**

**FOOT**

DATE: 13.3.2014

**4A**

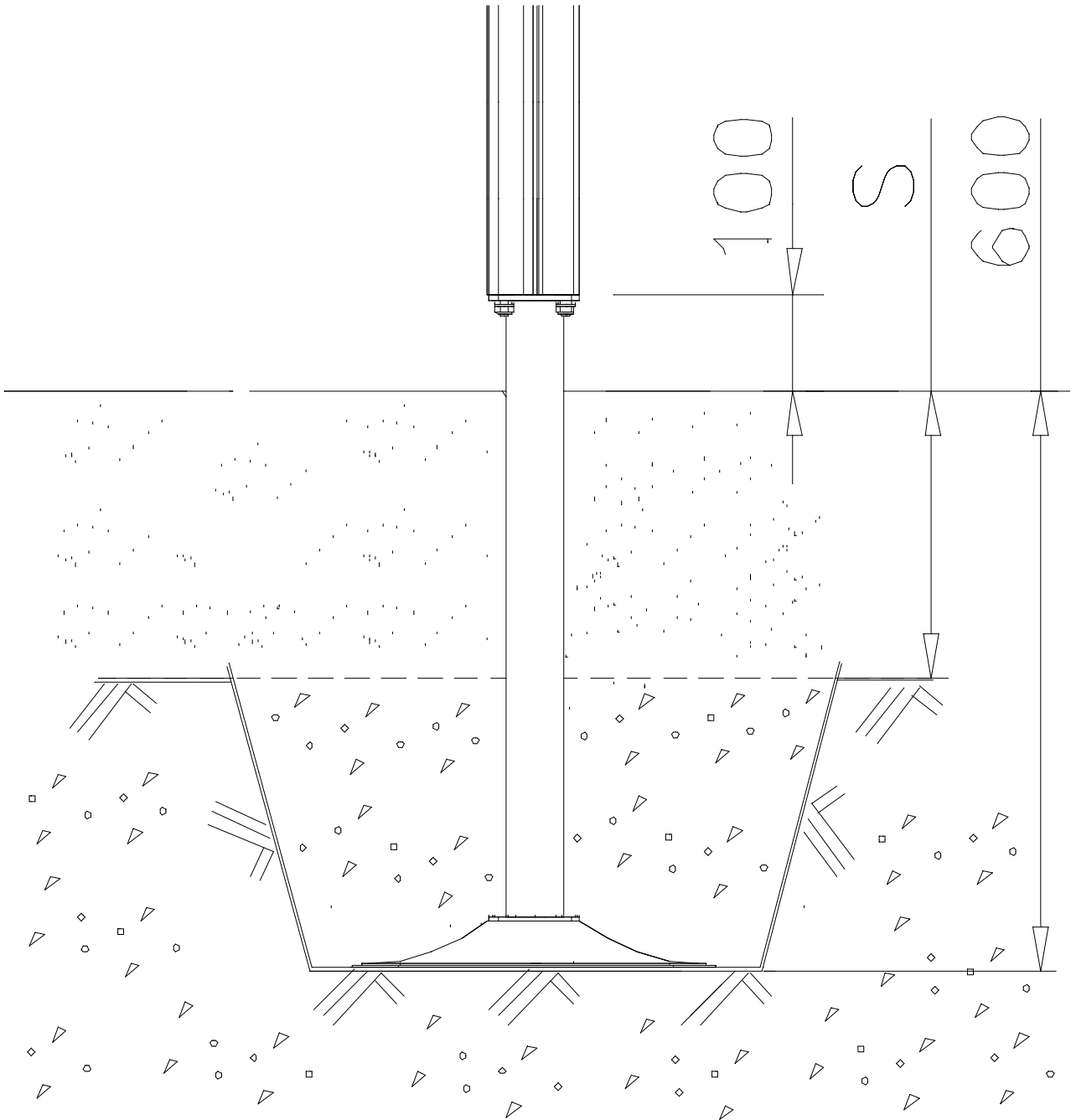
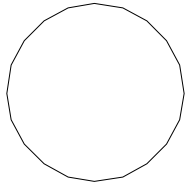



**LAPPSET®**  
**BETON FOUNDATION**

**FOOT**

DATE: 27.10.2015

**1(1)**

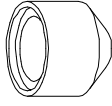
② 905104	PCS		PCS
	4		
 M10	PCS		PCS

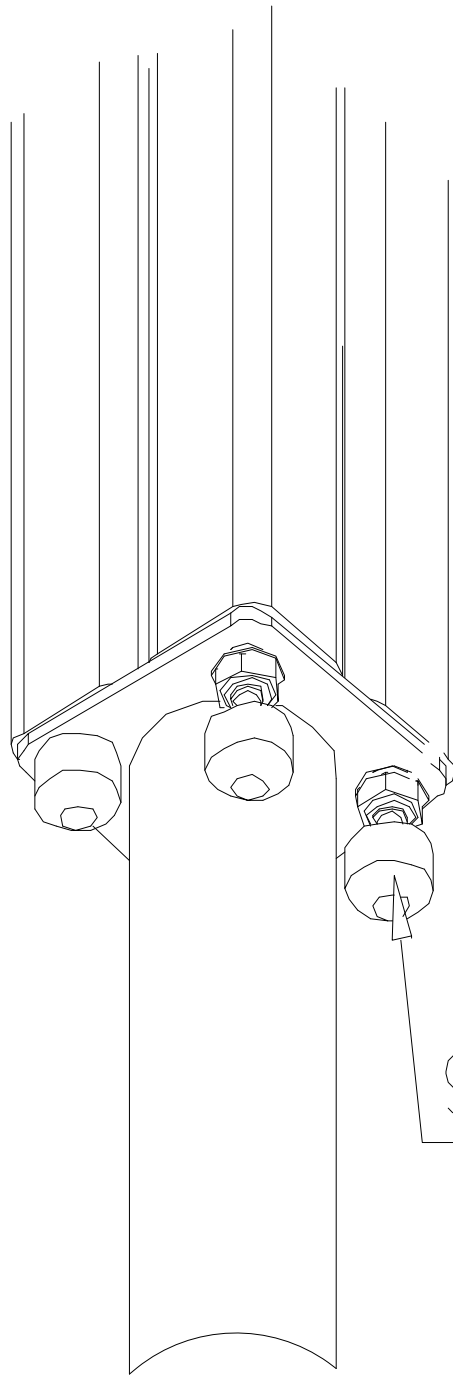

905104

# LAPPSET® DEEP FOUNDATION

# FOOT

DATE: 15.5.2018

1(1)

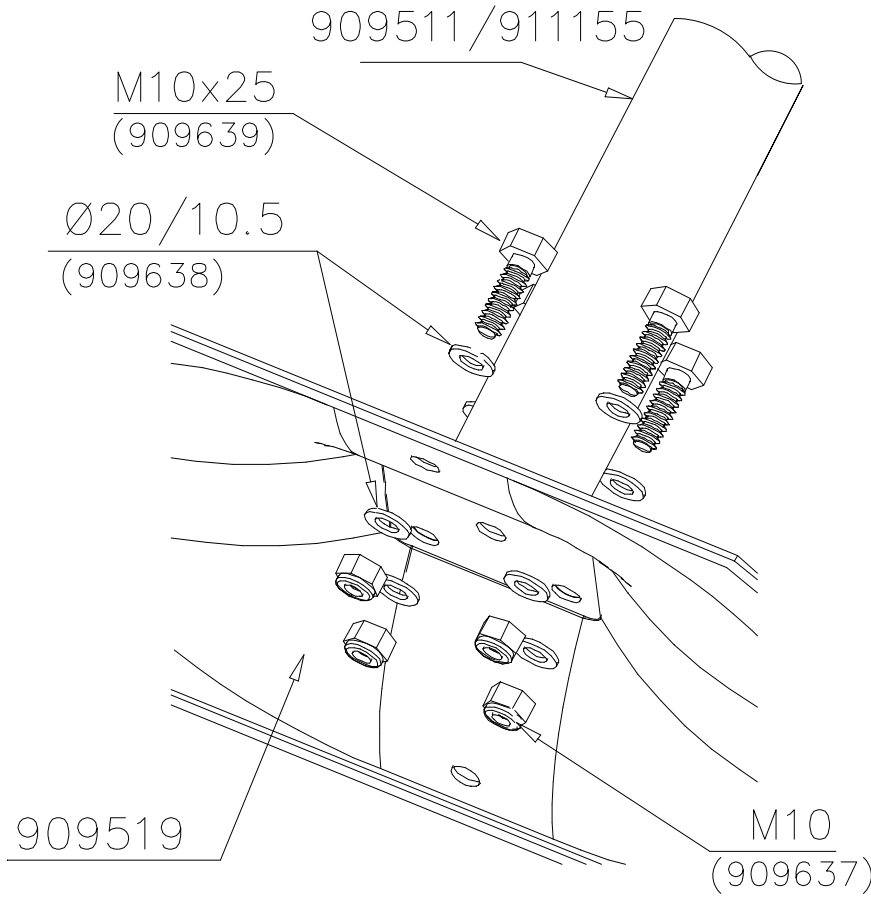

① 909511	PCS	② 909519	PCS
	1		1
90x90x650		50x380x380	
③ 909637	PCS	④ 909638	PCS
	4		8
M10		Ø20/10.5	
⑤ 909639	PCS	⑥ 905104	PCS
	4		4
M10x25		M10	

OPTION FOOT

① 911155	PCS		PCS
	1		
90x90x650			