

LAPPSET®

FINNO









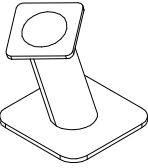
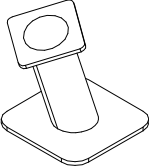
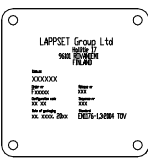

ASENNUSOHJE
MONTERINGSANSVISNING
INSTALLATION INSTRUCTION
AUFBAUANLEITUNG
NOTICE D'INSTALLATION

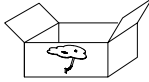
DATE: 30.9.2021

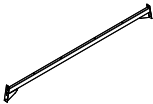
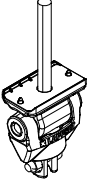
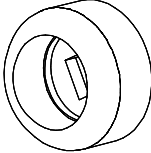
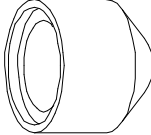
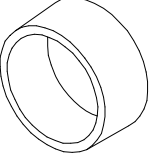
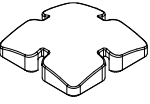
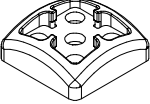
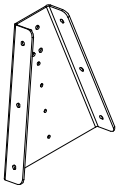
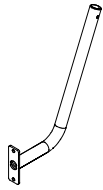
Q10174-2

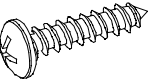
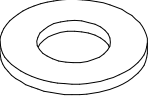
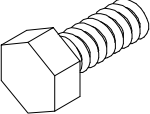
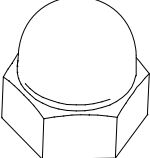
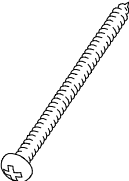
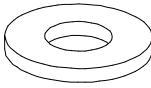

DATE: 30.9.2021

701902  L150	PCS 2	701903  L150	PCS 2	702286  65x65	PCS 1	706562-602  L2250	PCS 2	707665  M10	PCS 2	900965  M10	PCS 4
903149  M12x30	PCS 4	904333  L2940	PCS 1	904904  65x65	PCS 4	905090  Ø45	PCS 12	905104  M10	PCS 16	905115  Ø30	PCS 12
905138  M12x35	PCS 4	905196  Ø3.5x13	PCS 4	905991  336x392x40	PCS 2	908207-216  M12x35	PCS 2	909347  Ø3.5x13	PCS 12	909506  Ø3.5x13	PCS 4
909638  Ø20/10.5	PCS 8	909639  M10x25	PCS 4	909644  M12	PCS 4	980131  Ø6x60	PCS 16	980154  Ø24x13	PCS 20	999561  10g	PCS 1
P00940-602  L3150	PCS 2	P14796  10x750x1290	PCS 2		PCS		PCS		PCS		PCS
	PCS		PCS		PCS		PCS		PCS		PCS
	PCS		PCS		PCS		PCS		PCS		PCS

AS4685:2004 Impact Area 21.9 m²

No grid found

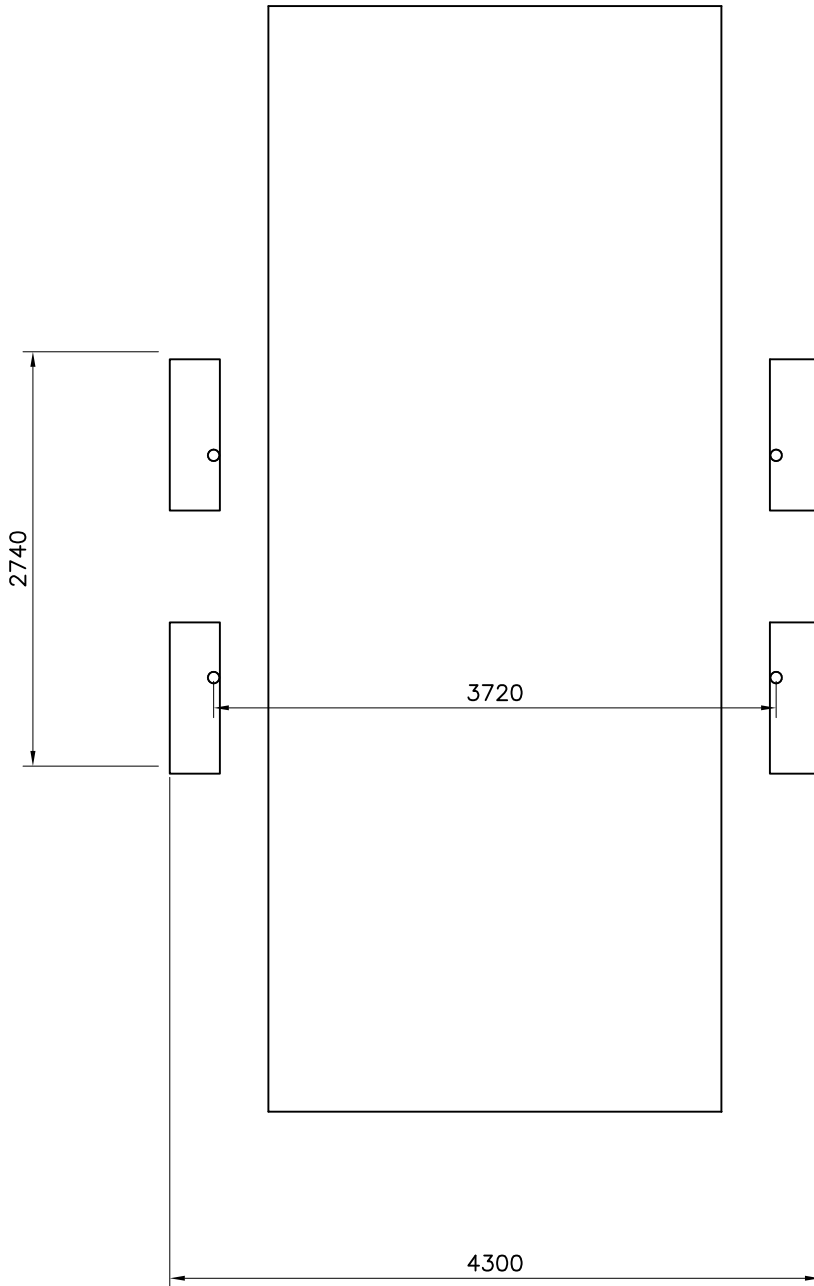
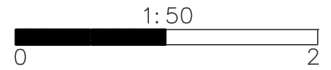

AS4685:2004 Impact Area 21.9 m²

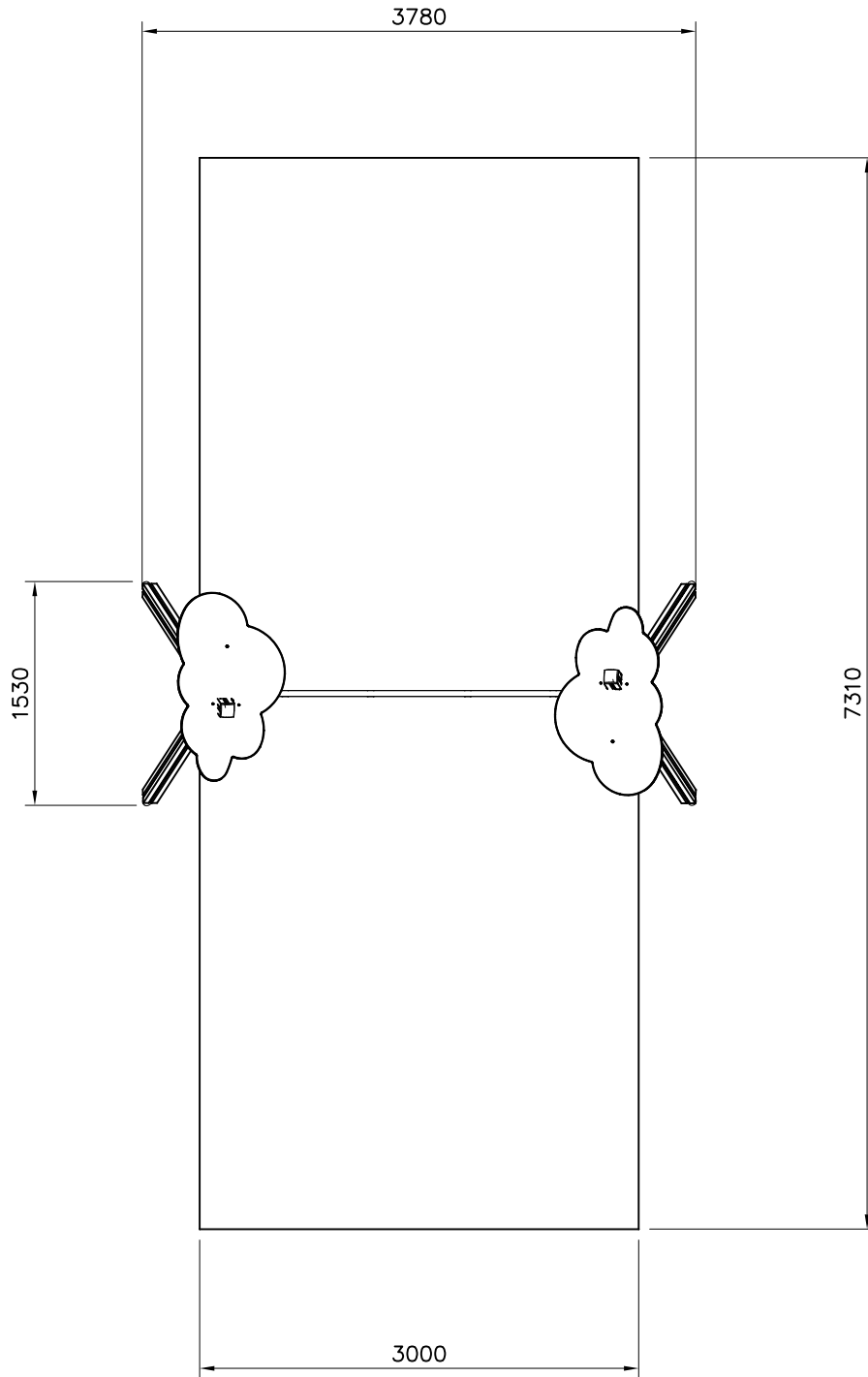
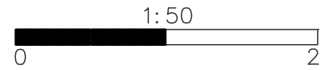

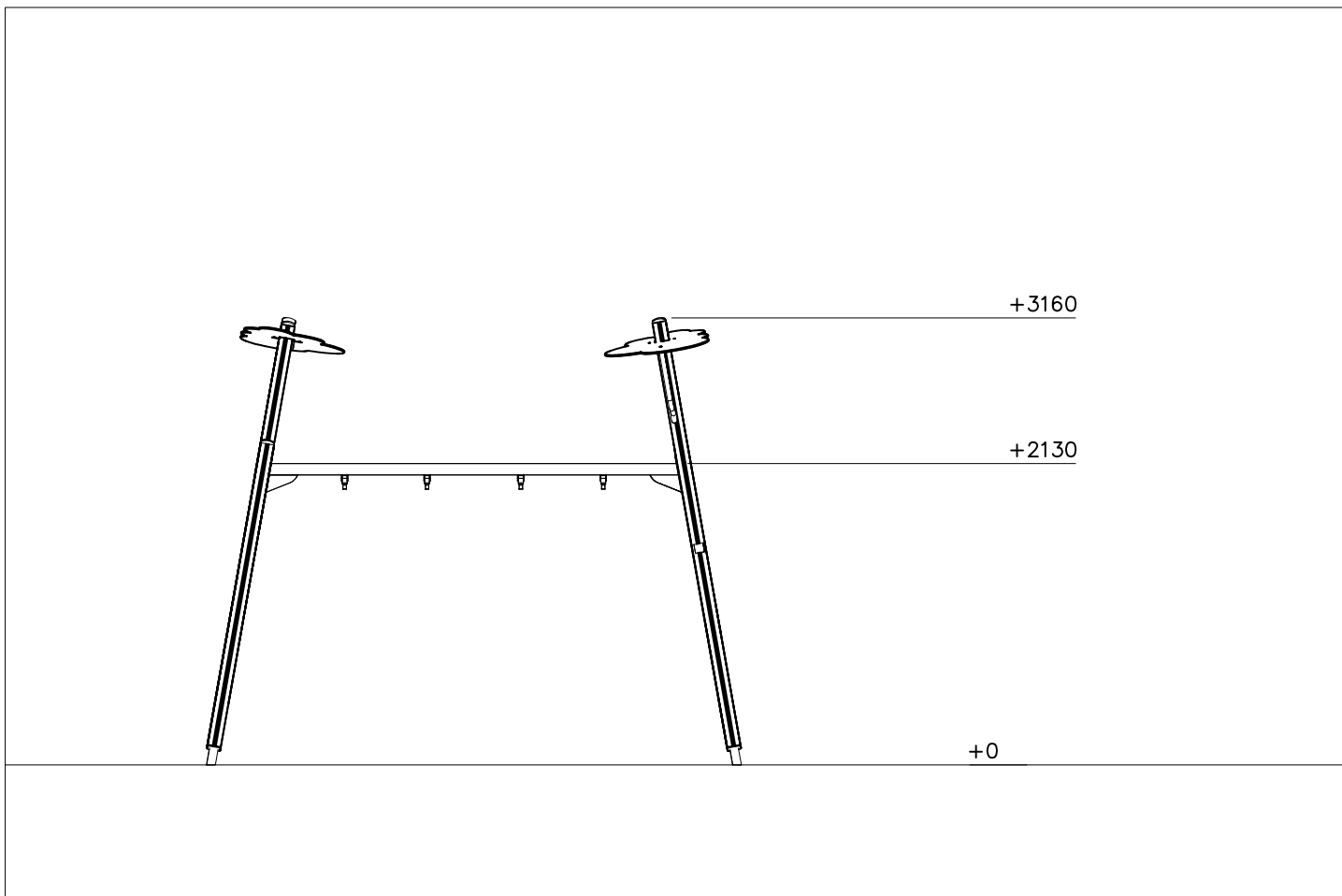

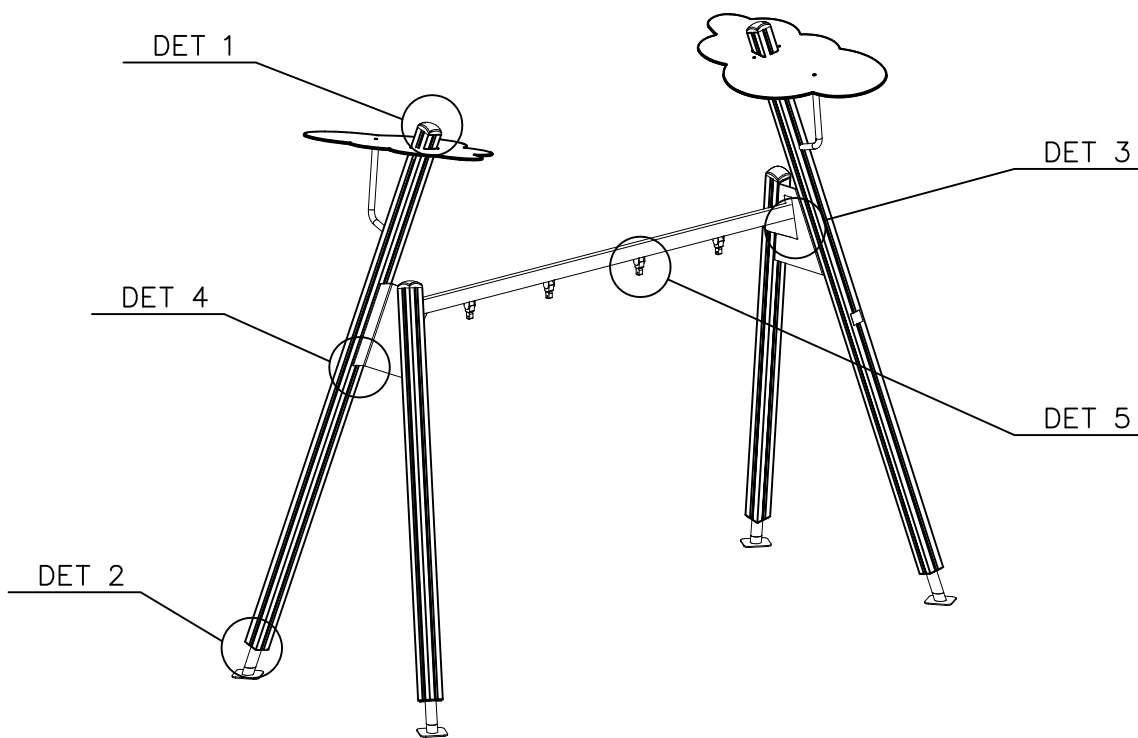

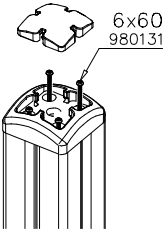
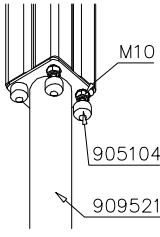
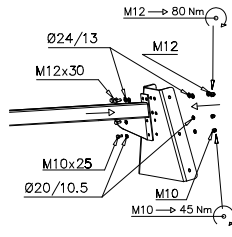
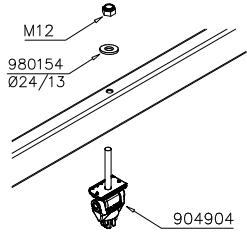
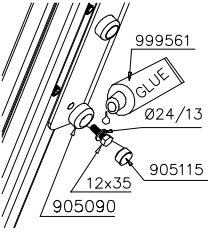

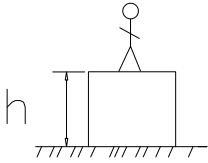

<p>DET 1</p>  <p>6x60 980131</p>	<p>DET 2</p>  <p>M10 905104 909521</p>	<p>DET 3</p>  <p>M12 → 80 Nm M12 Ø24/13 M12x30 M10x25 Ø20/10.5 M10 → 45 Nm</p>	<p>DET 4</p>  <p>M12 980154 Ø24/13 904904</p>
<p>DET 5</p>  <p>999561 GLUE Ø24/13 12x35 905115 905090</p>			

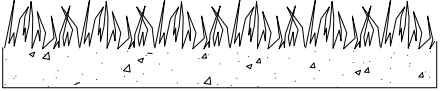
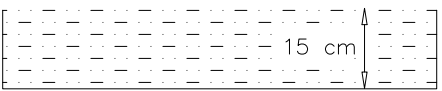
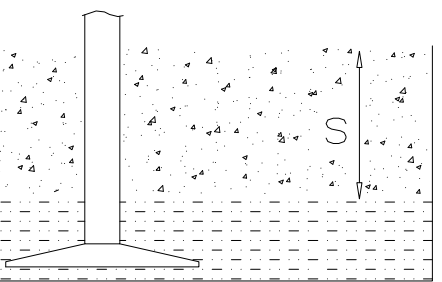
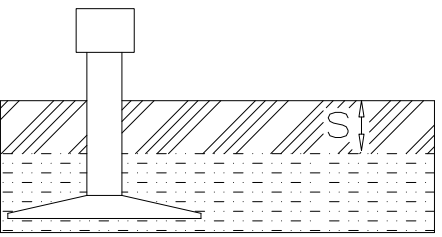

		
<p>$h < 600$</p> <p>Without movement and therefore without Impact Area</p>	<p>Totally hard surfaces.</p> <p>Note. Lappset does <u>not recommend</u> totally hard surfaces at all.</p>	<p>E.g. concrete or asphalt</p> 
<p>$h < 600$</p> <p>With movement e.g. rocking</p>	<p>Materials with very limited impact attenuating properties.</p>	<p>E.g. wood</p> 
<p>$h < 1000$</p>	<p>Materials with significant impact attenuating properties.</p>	<p>fine gravel 0–8 mm</p>  <p>grass</p>  <p>unsorted sand</p> 
<p>$h < 3000$</p>	<p>Loose fill material</p> <p>E.g. sand/gravel 0,25...8 mm D60/D10<3,0 Woodchips 5...30 mm bark 20...80 mm</p>	 <p>\underline{S} \underline{h}</p> <p>30 cm < 2,0 m</p> <p>40 cm < 3,0 m</p>
	<p>Syntethic granulates</p> <p>\underline{S} \underline{h}</p> <p>40 mm ~> 1,2...1,3 m</p> <p>50 mm ~> 1,5...1,7 m</p> <p>60 mm ~> 1,8...2,0 m</p> <p>70 mm ~> 2,1...2,5 m</p> <p>Note. For accurate values, see manufacturer's instructions.</p>	

REMOVE SAFETY SURFACE/SAND/GRAVEL
TO CHECK FOUNDATION

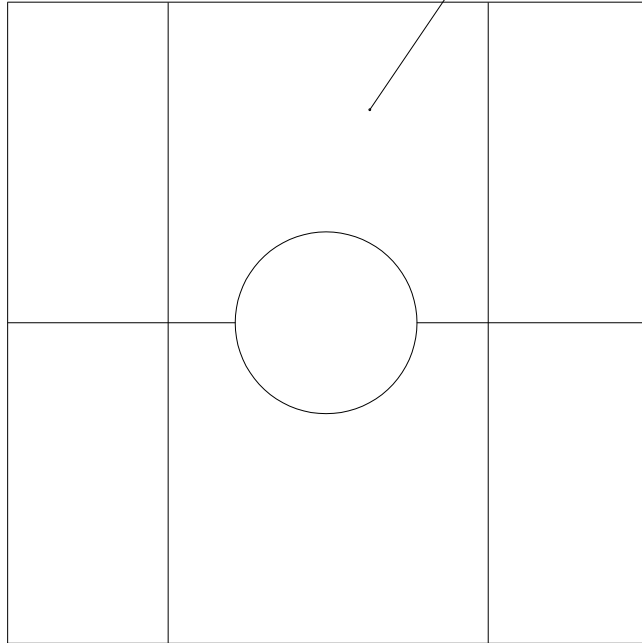

REMOVE SAFETY SURFACE/SAND/GRAVEL
TO CHECK FOUNDATION

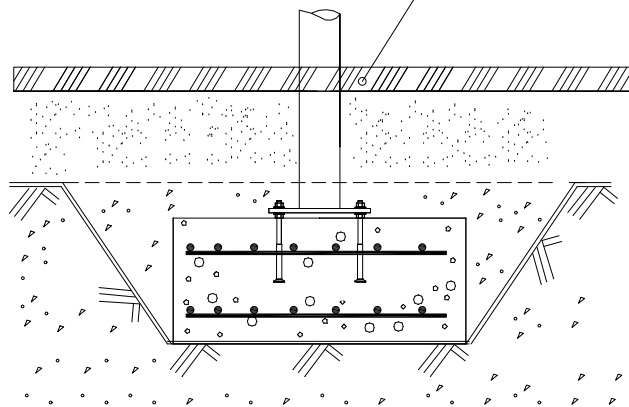

LAPPSET® BETON FOUNDATION

FOOT

DATE: 27.10.2015

1(1)

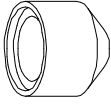
② 905104	PCS		PCS
	4		
 M10	PCS		PCS



905104

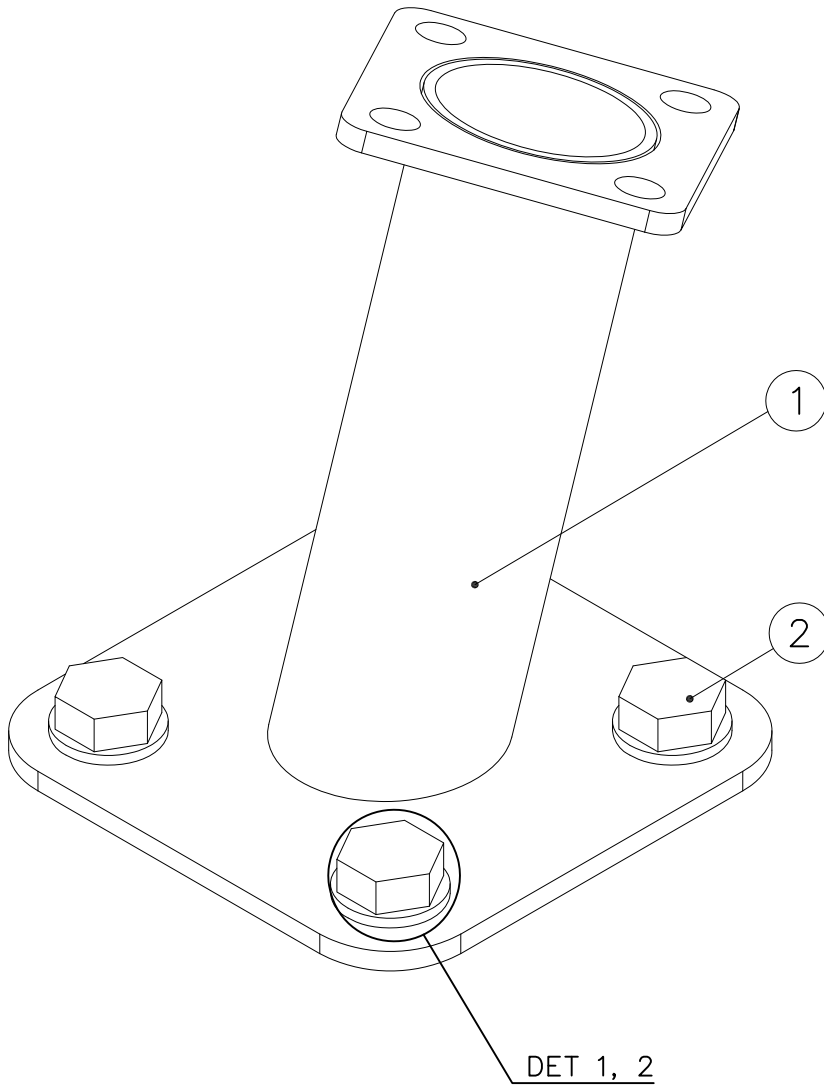

① 929550	PCS	① 929551	PCS
	1		1
RIGHT		LEFT	
	PCS		PCS
	PCS		PCS
	PCS		PCS
② 909520	PCS	③ 929426	PCS
	4		4
Ø30/17		M16x100	
④ 929914	PCS		PCS
	4		
M16x110			

DET 1

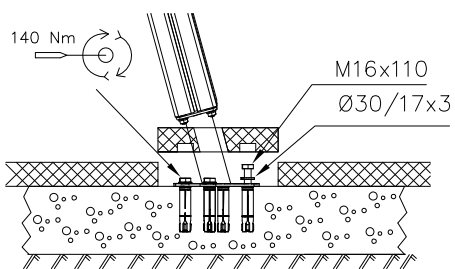

DET 2

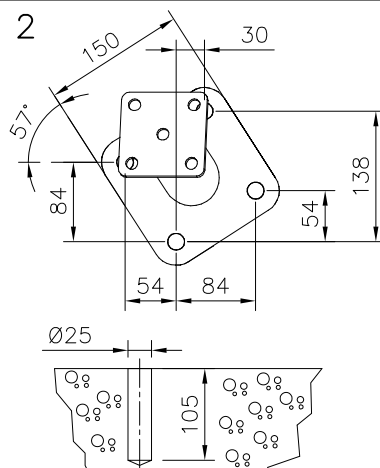

DET 3

**Tuotekyltti tulee tuotteen mukana yhdellä seuraavista tavoista:****1) Metallinen tuotekyltti ja kiinnitysruuvit**

- Kiinnitä tuotekyltti ruuveilla tolppaan noin 2 metrin korkeuteen kuvan 1 mukaisesti.

2) Tuotekylttitarra

- Puhdista maalattu metalli- tai vaneripinta pölystä ja kosteudesta. Liimaa tarra kuvan 2 mukaisesti.
- Huom. Älä kiinnitä tarraa karheapintaiseen laminaattiin tai maalattuun puuhun.

Vår produktmärkning levereras på ett av följande sätt:**1) Produktskylt i metall**

- Fäst skylten med de medföljande skruvarna

2) Självhäftande produktetikett

- Rengör den pulverlackerade metallytan eller laminatyten så att den blir fri från smuts och fukt. Fäst etiketten enligt fig. 2.
- Obs! Fäst ej etiketten på detaljer med skrovlig yta eller på målat trä.

Product label is delivered by one of following ways:**1) Metal product label and screws**

- Fasten the label with screws.

2) Label sticker

- Clean the painted metal or plywood surface from dirt and moisture. Fasten the sticker as shown in the figure 2.
- Note. Do not attach the sticker to rough surfaced laminate or painted wood.

La plaque d'informations produit est livrée sous l'une de ces 3 formes :**1) Plaque métallique et vis**

- Fixez la plaque à l'aide des vis.

2) Etiquette autocollante

- Avant de coller l'étiquette, nettoyez le composant métallique peint ou la plaque de contreplaqué, de toute saleté. La surface doit être sèche (voir image 2).
- Attention, ne pas coller l'étiquette sur une surface lamellé-collée irrégulière ou sur du bois peint.

Die Auslieferung des Produktaufklebers erfolgt auf eine dieser Arten:**1) Produkt-Schild aus Metall incl. Schrauben**

- Die Befestigung des Schildes erfolgt mittels der Schrauben.

2) Aufkleber

- Entfernen Sie zunächst Schmutz und Feuchtigkeit vom lackierten Metall bzw. von der Holzoberfläche und bringen Sie den Aufkleber wie im Bild oben rechts beschrieben auf den gesäuberten Untergrund auf.
- Beachten Sie: Bringen Sie den Aufkleber nicht auf raues laminiertes oder lackiertes Holz an.

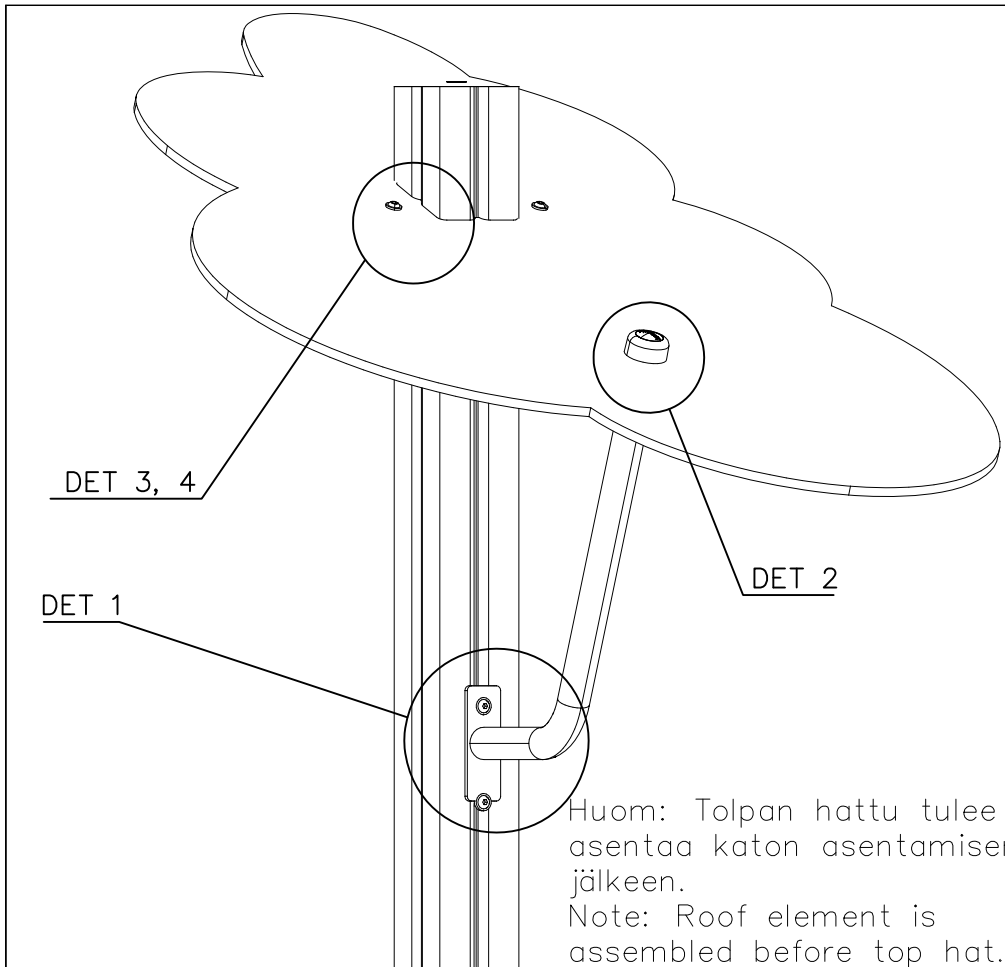

① 900240	PCS	② 901570	PCS
	4		2
Ø8x70		36x55x55	
③ 980154	PCS	④ 905086	PCS
	1		1
Ø24/13		Ø44/13,5	
⑤ 905090	PCS	⑥ 905115	PCS
	1		1
Ø45		Ø30	
⑦ 909142	PCS	⑧ 980160	PCS
	1		2
M12x70		M8	
⑨ 909852	PCS		PCS
	2		
M8x30			
	PCS		PCS

DET 1

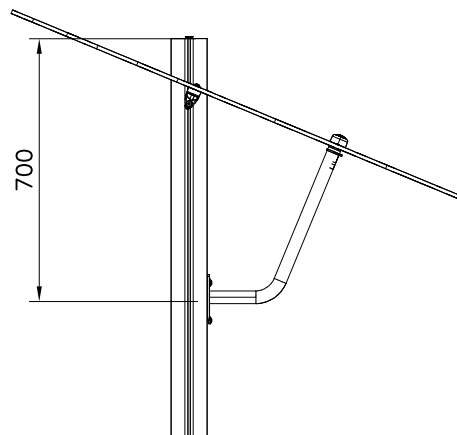
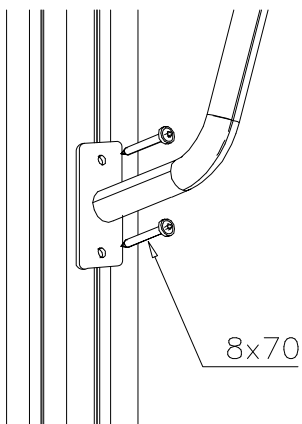

DET 2

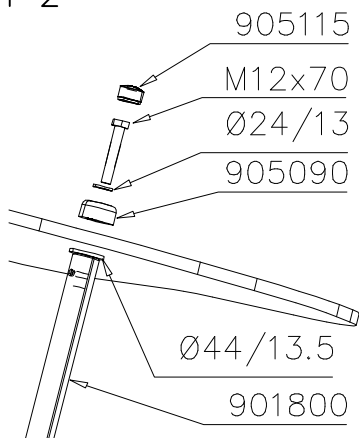

DET 3

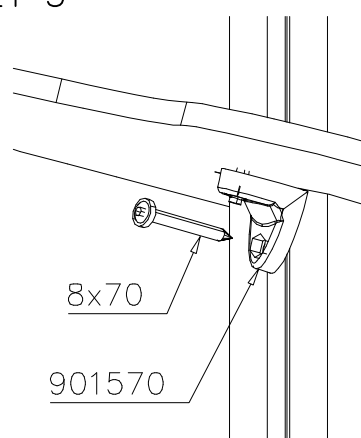

DET 4

