

LAPPSET®

FINNO



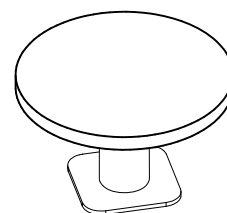
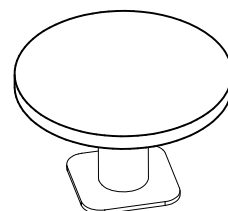
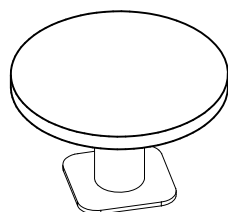
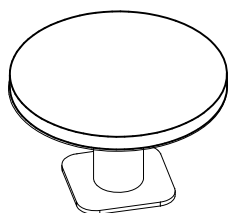

ASENNUSOHJE
MONTERINGSANSVISNING
INSTALLATION INSTRUCTION
AUFBAUANLEITUNG
NOTICE D'INSTALLATION

DATE: 2.9.2021

Q15720

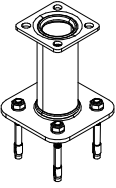

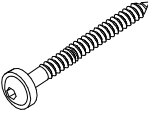
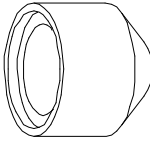
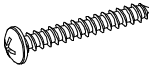
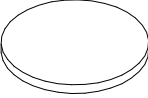
DATE: 2.9.2021

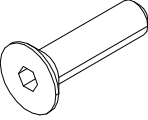
701898  4	PCS 4	702286  65x65 1	PCS 1	903093  8x90 16	PCS 16	905104  M10 16	PCS 16	980114  Ø4x20 4	PCS 4	P15904  Ø280 4	PCS 4
909637  Ø20/10,5	PCS 16	901302  Ø20x10,5x2	PCS 32	901487  Ø10x40	PCS 16		PCS		PCS		PCS
	PCS		PCS		PCS		PCS		PCS		PCS
	PCS		PCS		PCS		PCS		PCS		PCS
	PCS		PCS		PCS		PCS		PCS		PCS
	PCS		PCS		PCS		PCS		PCS		PCS
	PCS		PCS		PCS		PCS		PCS		PCS

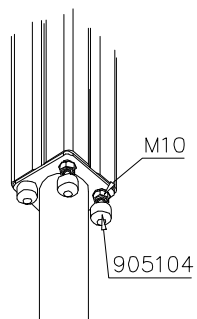
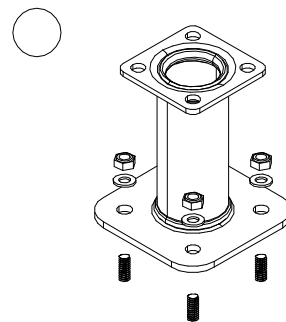
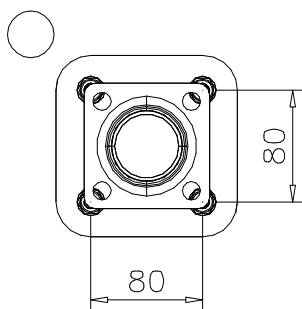
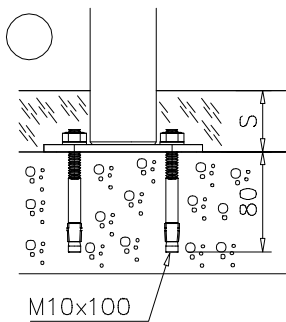

----- Falling Space 15.8 m²
Max Falling Height 170 mm

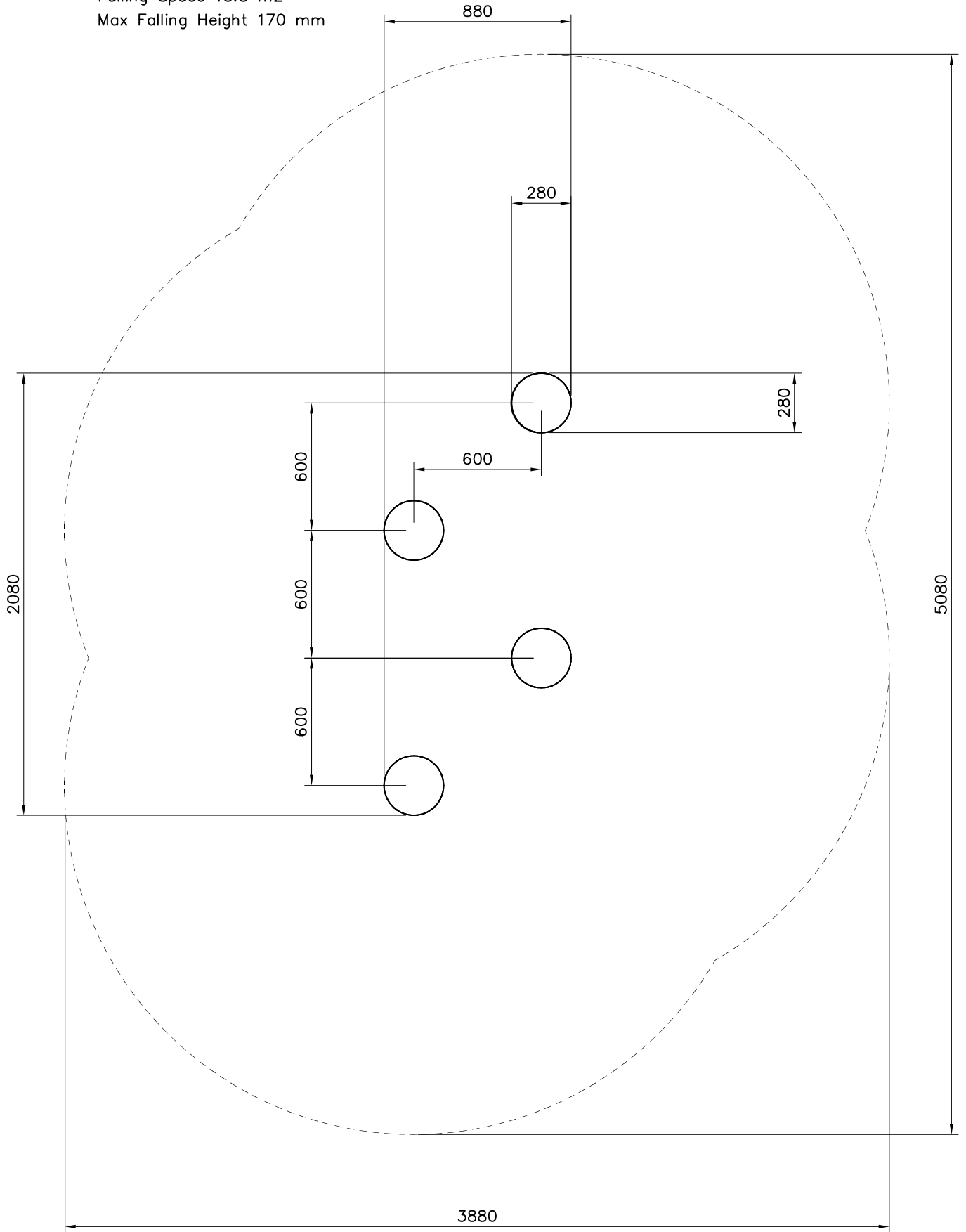

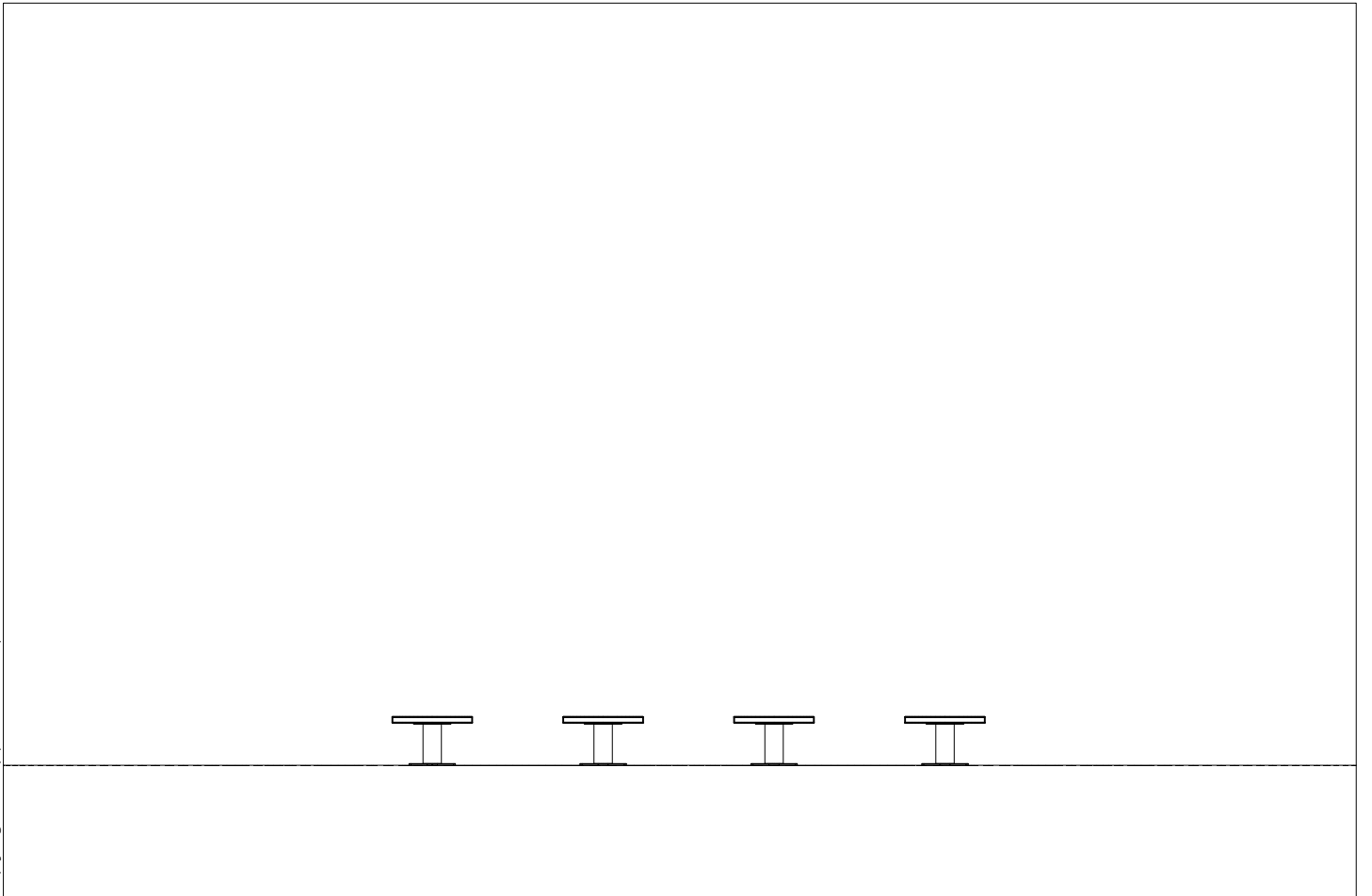
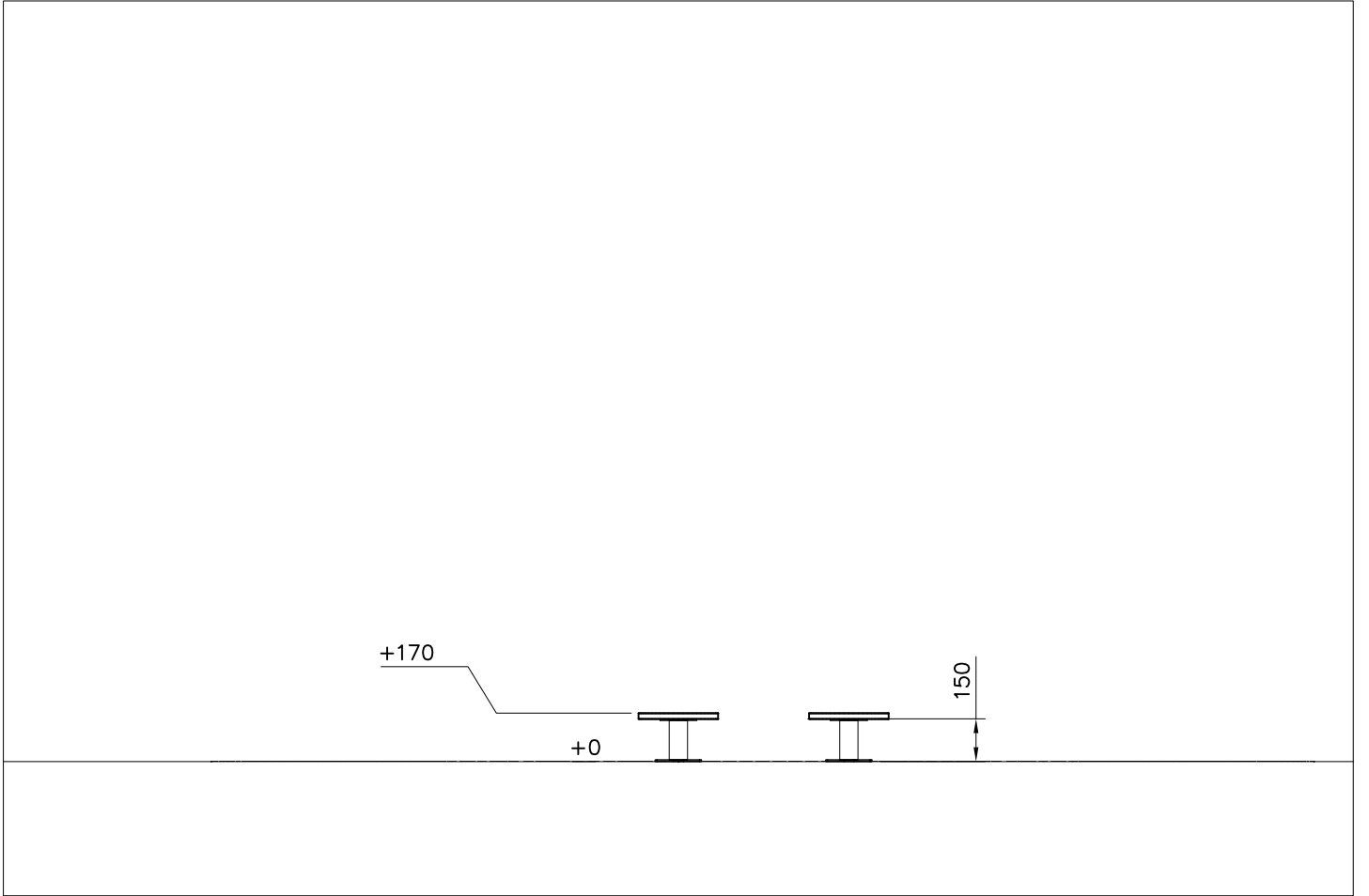

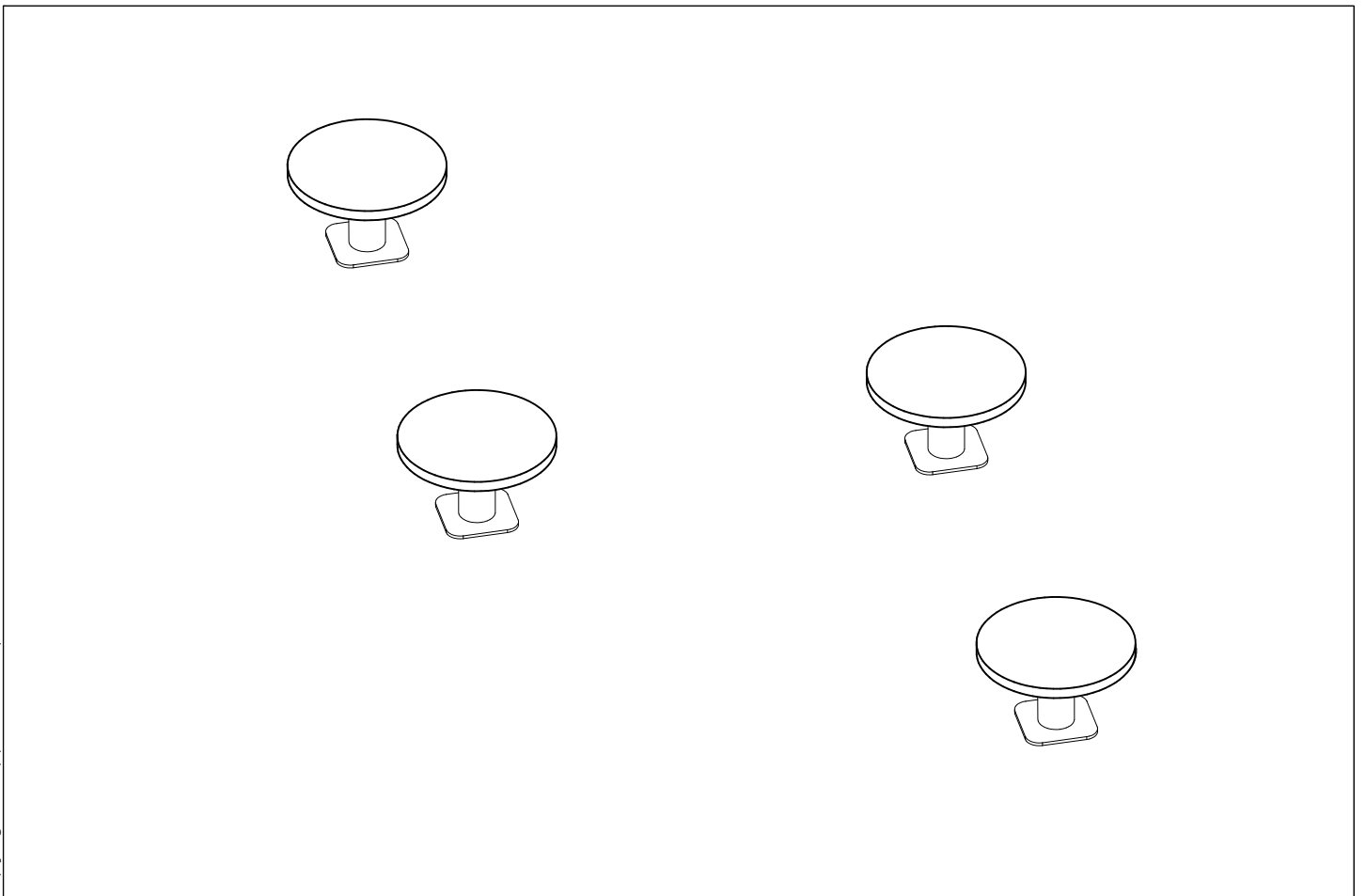
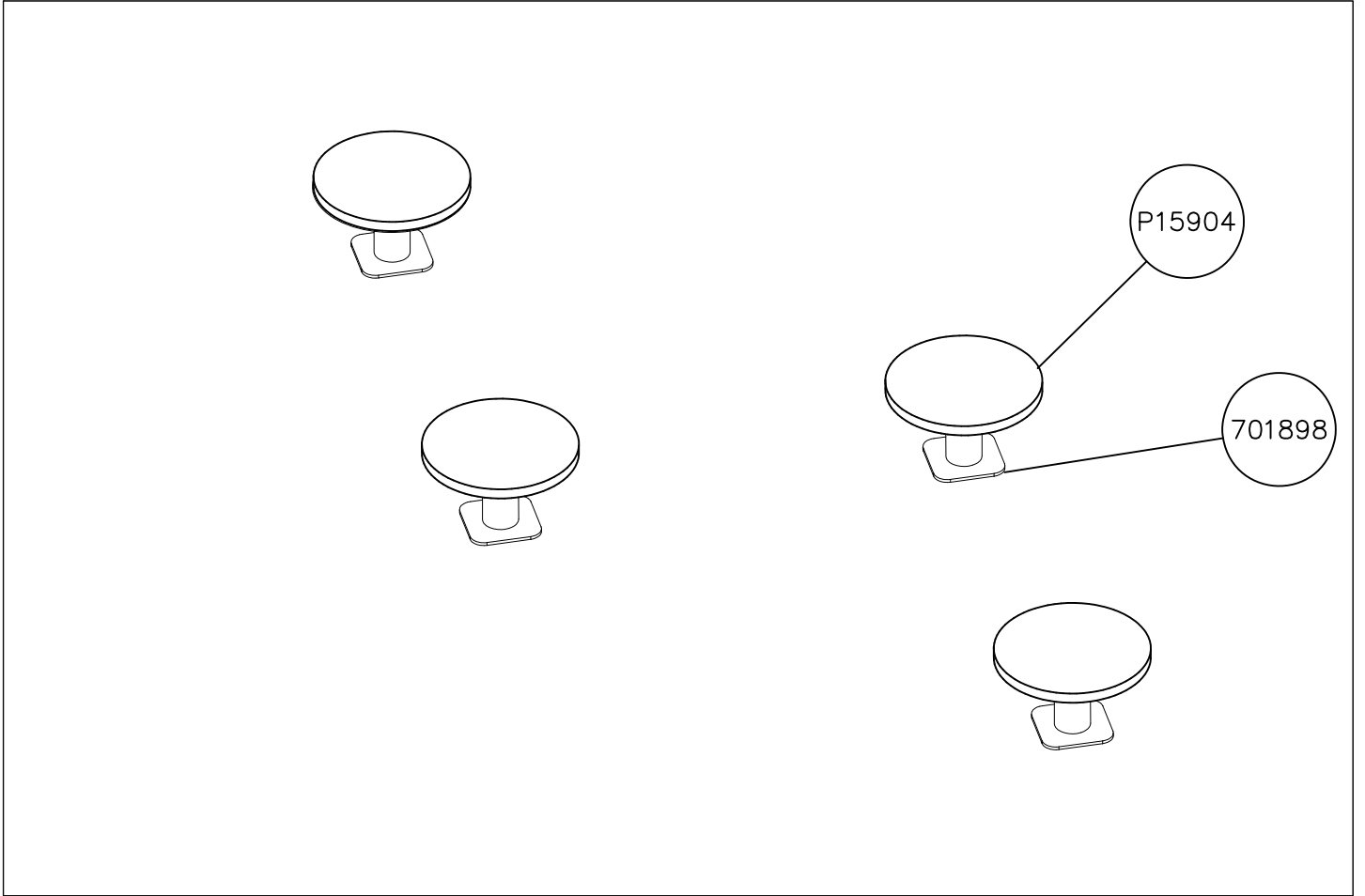



DET 1, 2, 3

① 909531	PCS	① 909513	PCS
	1		1
		60°	
① 909514	PCS	① 902056	PCS
	1		1
		75°	57°
① 902062	PCS		PCS
	1		
		70°	
	PCS		PCS
	PCS		PCS
② 909628	PCS		PCS
	4		
M10x100			

DET 1

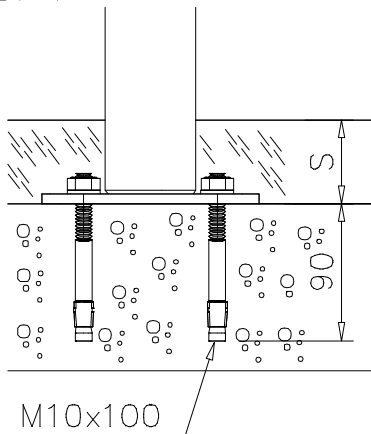

M10x100

DET 2

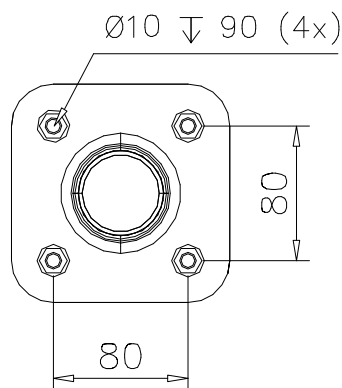

DET 3

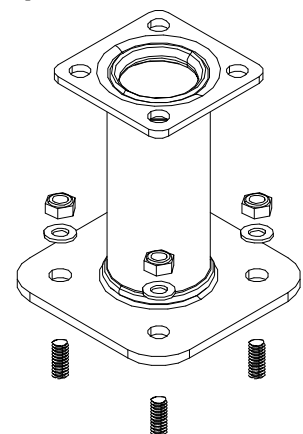



Tuotekyltti tulee tuotteen mukana yhdellä seuraavista tavoista:

1) Metallinen tuotekyltti ja kiinnitysruuvit

- Kiinnitä tuotekyltti ruuveilla tolppaan noin 2 metrin korkeuteen kuvan 1 mukaisesti.

2) Tuotekylttitarra

- Puhdista maalattu metalli- tai vaneripinta pölystä ja kosteudesta. Liimaa tarra kuvan 2 mukaisesti.
- Huom. Älä kiinnitä tarraa karheapintaiseen laminaattiin tai maalattuun puuhun.

Vår produktmärkning levereras på ett av följande sätt:

1) Produktskylt i metall

- Fäst skylten med de medföljande skruvarna

2) Självhäftande produktetikett

- Rengör den pulverlackerade metallytan eller laminatyten så att den blir fri från smuts och fukt. Fäst etiketten enligt fig. 2.
- Obs! Fäst ej etiketten på detaljer med skrovlig yta eller på målat trä.

Product label is delivered by one of following ways:

1) Metal product label and screws

- Fasten the label with screws.

2) Label sticker

- Clean the painted metal or plywood surface from dirt and moisture. Fasten the sticker as shown in the figure 2.
- Note. Do not attach the sticker to rough surfaced laminate or painted wood.

La plaque d'informations produit est livrée sous l'une de ces 3 formes :

1) Plaque métallique et vis

- Fixez la plaque à l'aide des vis.

2) Etiquette autocollante

- Avant de coller l'étiquette, nettoyez le composant métallique peint ou la plaque de contreplaqué, de toute saleté. La surface doit être sèche (voir image 2).
- Attention, ne pas coller l'étiquette sur une surface lamellé-collée irrégulière ou sur du bois peint.

Die Auslieferung des Produktaufklebers erfolgt auf eine dieser Arten:

1) Produkt-Schild aus Metall incl. Schrauben

- Die Befestigung des Schildes erfolgt mittels der Schrauben.

2) Aufkleber

- Entfernen Sie zunächst Schmutz und Feuchtigkeit vom lackierten Metall bzw. von der Holzoberfläche und bringen Sie den Aufkleber wie im Bild oben rechts beschrieben auf den gesäuberten Untergrund auf.
- Beachten Sie: Bringen Sie den Aufkleber nicht auf raues laminiertes oder lackiertes Holz an.