

LAPPSET®

FINNO



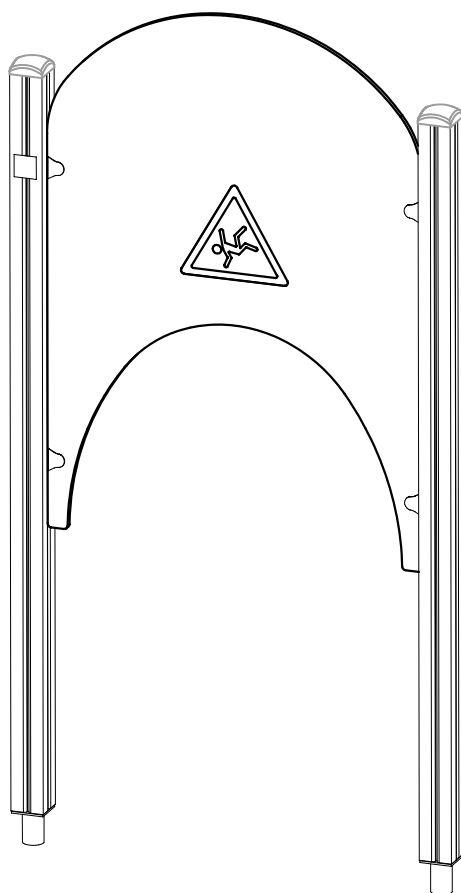

ASENNUSOHJE
MONTERINGSANSVISNING
INSTALLATION INSTRUCTION
AUFBAUANLEITUNG
NOTICE D'INSTALLATION

DATE: 22.6.2021

Q15668-1

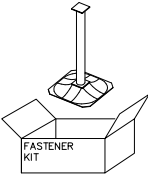
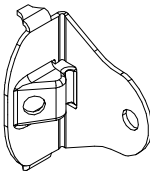
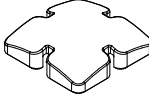
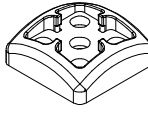
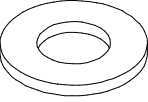
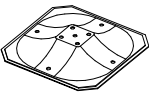
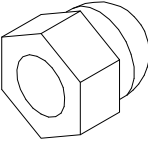

DATE: 5.7.2021

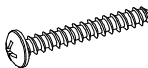
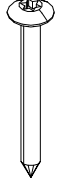
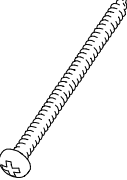
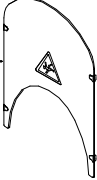
702286  65x65	PCS 1	706484-614  93x93x2150	PCS 2	706531  FASTENER KIT	PCS 2	903176 	PCS 4	905138  GRAY	PCS 2	905196  GRAY	PCS 2
909256  Ø16/8.4x1.6	PCS 4	909519  50x380x380	PCS 2	909633  M8	PCS 4	909852  M8x30	PCS 4	911155  90x90x650	PCS 2	980114  Ø4x20	PCS 4
980123  Ø7x60	PCS 4	980131  Ø6x60	PCS 8	P14624  15x900x1100	PCS 1		PCS		PCS		PCS
	PCS		PCS		PCS		PCS		PCS		PCS
	PCS		PCS		PCS		PCS		PCS		PCS
	PCS		PCS		PCS		PCS		PCS		PCS
	PCS		PCS		PCS		PCS		PCS		PCS

CONCRETE BLOCK 500x500x300
(x2)

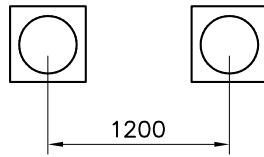

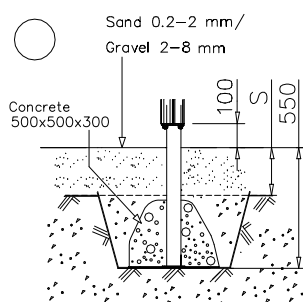
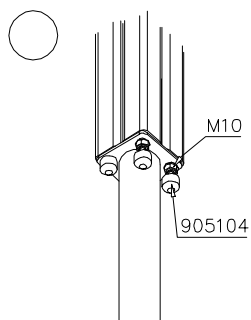

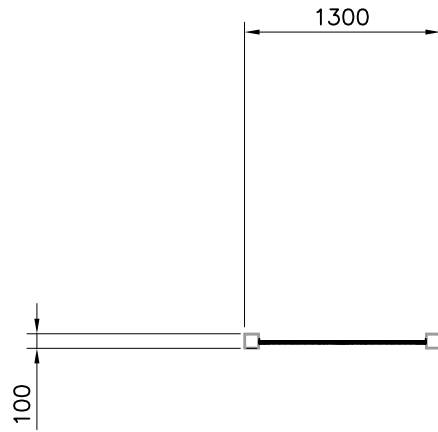
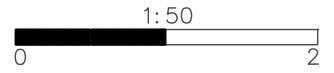

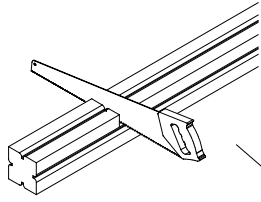

Height/positon
of the plate
P14624
depends on
the tube slide.
Cut off the
extra length
of the posts
when plate is
fixed.

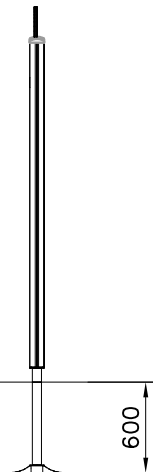
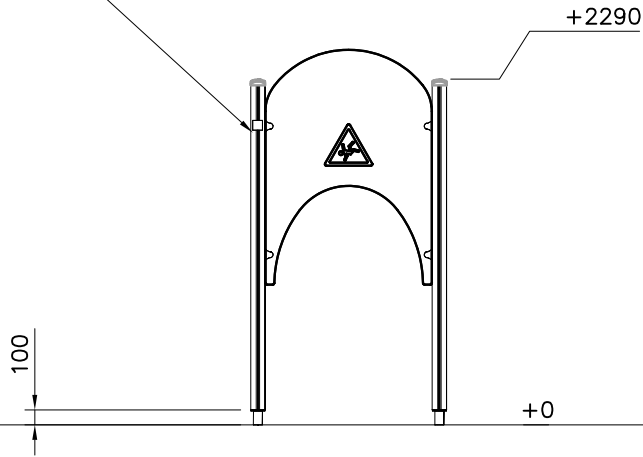

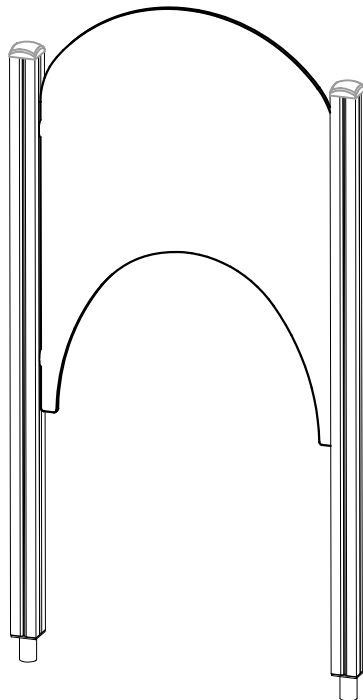
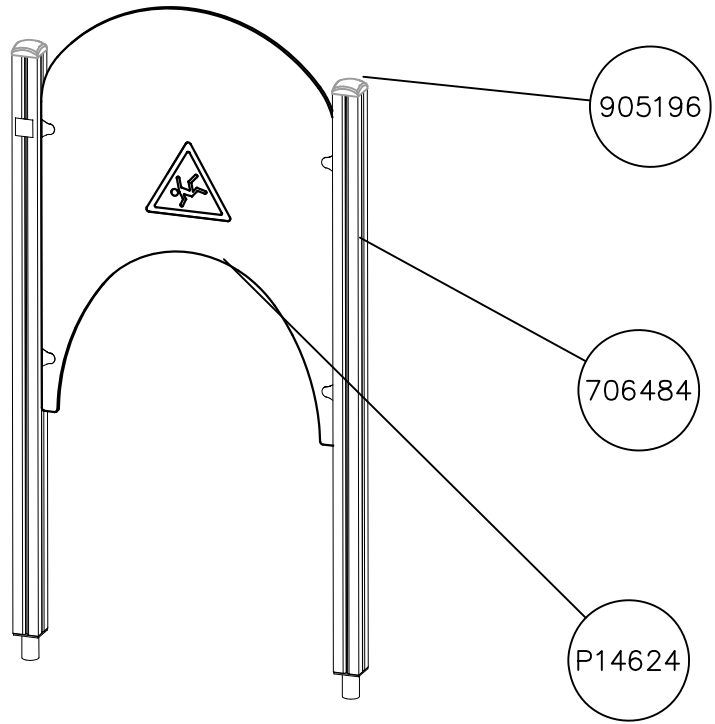

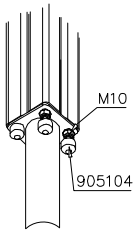
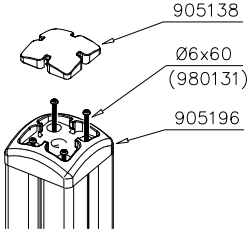
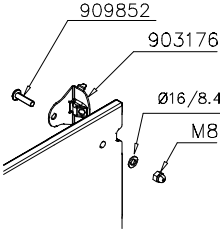
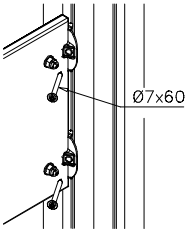
<p>DET 1</p> 	<p>DET 2</p> 	<p>DET 3</p> 	<p>DET 4</p> 

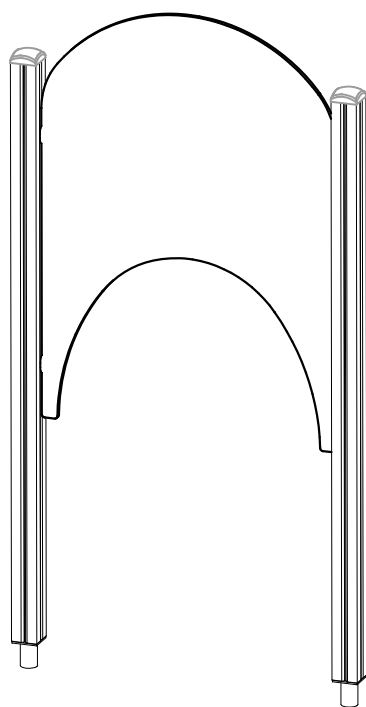
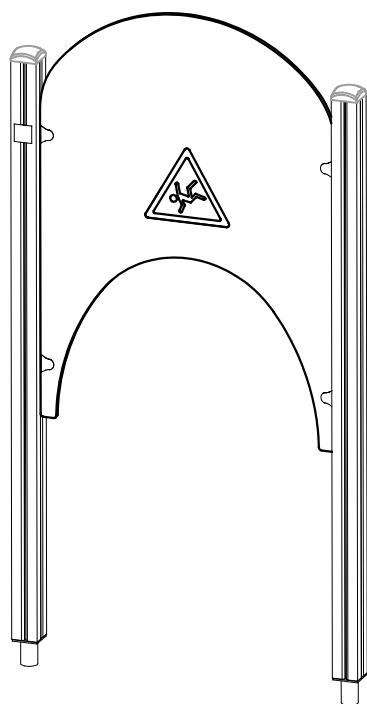



Tuotekyltti tulee tuotteen mukana yhdellä seuraavista tavoista:

1) Metallinen tuotekyltti ja kiinnitysruuvit

- Kiinnitä tuotekyltti ruuveilla tolppaan noin 2 metrin korkeuteen kuvan 1 mukaisesti.

2) Tuotekylttitarra

- Puhdista maalattu metalli- tai vaneripinta pölystä ja kosteudesta. Liimaa tarra kuvan 2 mukaisesti.
- Huom. Älä kiinnitä tarraa karheapintaiseen laminaattiin tai maalattuun puuhun.

Vår produktmärkning levereras på ett av följande sätt:

1) Produktskylt i metall

- Fäst skylten med de medföljande skruvarna

2) Självhäftande produktetikett

- Rengör den pulverlackerade metallytan eller laminatyten så att den blir fri från smuts och fukt. Fäst etiketten enligt fig. 2.
- Obs! Fäst ej etiketten på detaljer med skrovlig yta eller på målat trä.

Product label is delivered by one of following ways:

1) Metal product label and screws

- Fasten the label with screws.

2) Label sticker

- Clean the painted metal or plywood surface from dirt and moisture. Fasten the sticker as shown in the figure 2.
- Note. Do not attach the sticker to rough surfaced laminate or painted wood.

La plaque d'informations produit est livrée sous l'une de ces 3 formes :

1) Plaque métallique et vis

- Fixez la plaque à l'aide des vis.

2) Etiquette autocollante

- Avant de coller l'étiquette, nettoyez le composant métallique peint ou la plaque de contreplaqué, de toute saleté. La surface doit être sèche (voir image 2).
- Attention, ne pas coller l'étiquette sur une surface lamellé-collée irrégulière ou sur du bois peint.

Die Auslieferung des Produktaufklebers erfolgt auf eine dieser Arten:

1) Produkt-Schild aus Metall incl. Schrauben

- Die Befestigung des Schildes erfolgt mittels der Schrauben.

2) Aufkleber

- Entfernen Sie zunächst Schmutz und Feuchtigkeit vom lackierten Metall bzw. von der Holzoberfläche und bringen Sie den Aufkleber wie im Bild oben rechts beschrieben auf den gesäuberten Untergrund auf.
- Beachten Sie: Bringen Sie den Aufkleber nicht auf raues laminiertes oder lackiertes Holz an.



LAPPSET®
BETON FOUNDATION

FOOT

DATE: 27.10.2015

1(1)

② 905104	PCS		PCS
	4		
 M10	PCS		PCS



905104

LAPPSET® DEEP FOUNDATION

FOOT

DATE: 15.5.2018

1(1)



①	909511	PCS	②	909519	PCS
		1			1
	90x90x650			50x380x380	

③	909637	PCS	④	909638	PCS
		4			8
	M10			Ø20/10.5	

⑤	909639	PCS	⑥	905104	PCS
		4			4
	M10x25			M10	

OPTION FOOT

①	911155	PCS			PCS
		1			
	90x90x650				