

# LAPPSET®







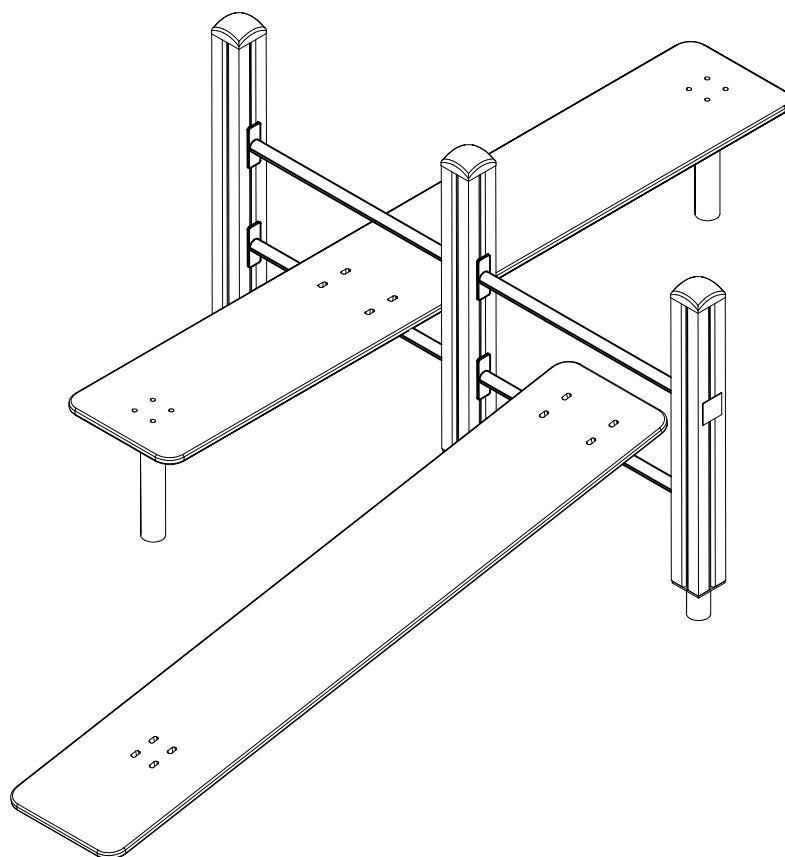

## FINNO

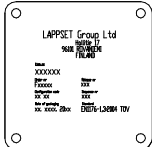
ASENNUSOHJE  
MONTERINGSANSVISNING  
INSTALLATION INSTRUCTION  
AUFBAUANLEITUNG  
NOTICE D'INSTALLATION

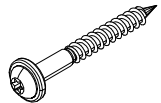
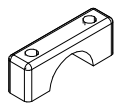
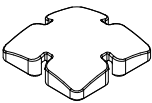
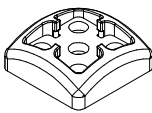
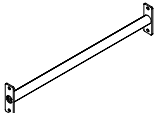
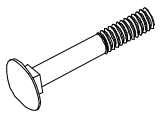
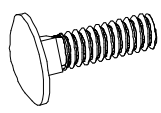
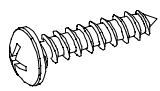
DATE: 10.6.2021

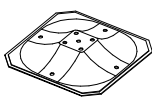
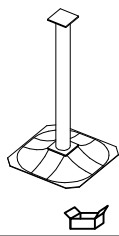
### Q12451-2

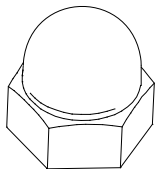
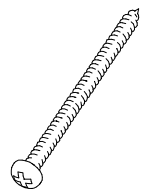
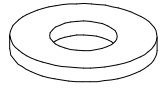
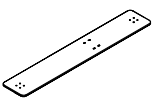

702286  65x65	PCS 1	706499  93x93x860	PCS 3	706531	PCS 3	900240  Ø8x70	PCS 16	902454 	PCS 4	905138  GRAY	PCS 3
905196  GRAY	PCS 3	907694 -217  L 704	PCS 4	909107  M12x80	PCS 8	909109  M12x40	PCS 12	909506  Ø3.5x13	PCS 4	909511  90x90x650	PCS 3
909519  50x380x380	PCS 3	909521  	PCS 3	909644  M12	PCS 20	980131  Ø6x60	PCS 12	980154  Ø24/13	PCS 68	P01986  2200x380	PCS 1
P01987  2000x380	PCS 1		PCS		PCS		PCS		PCS		PCS
	PCS		PCS		PCS		PCS		PCS		PCS
	PCS		PCS		PCS		PCS		PCS		PCS

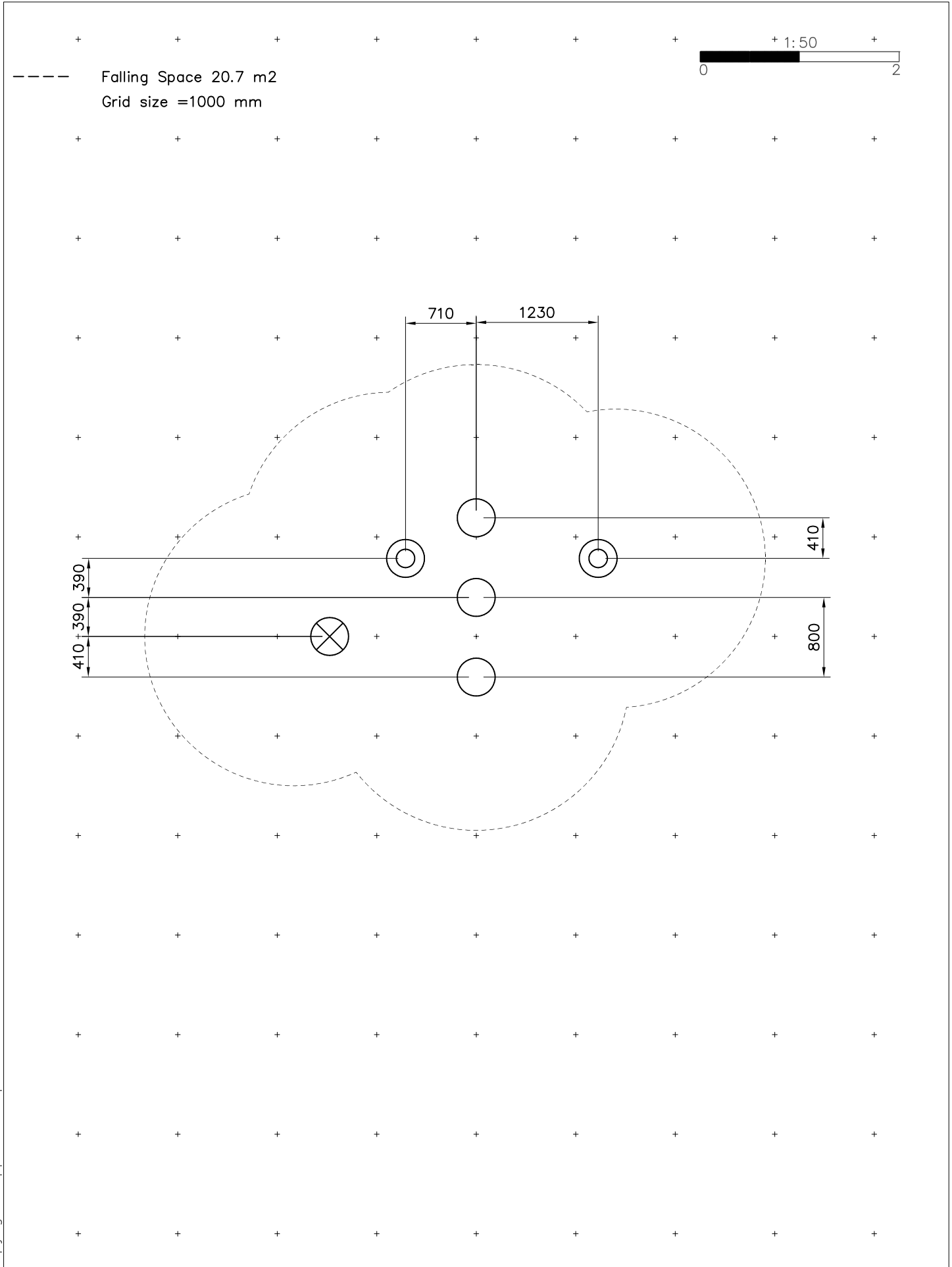

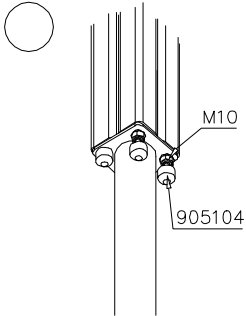
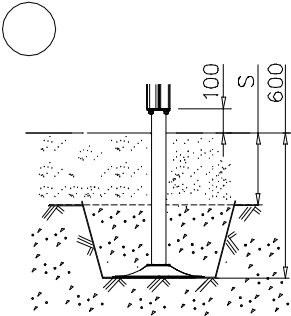
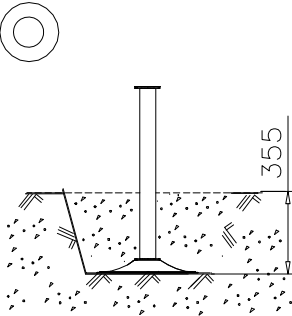
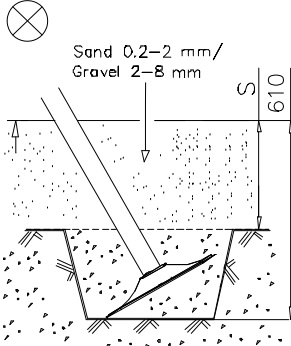

----- Falling Space 20.7 m<sup>2</sup>  
Max Falling Height 450 mm

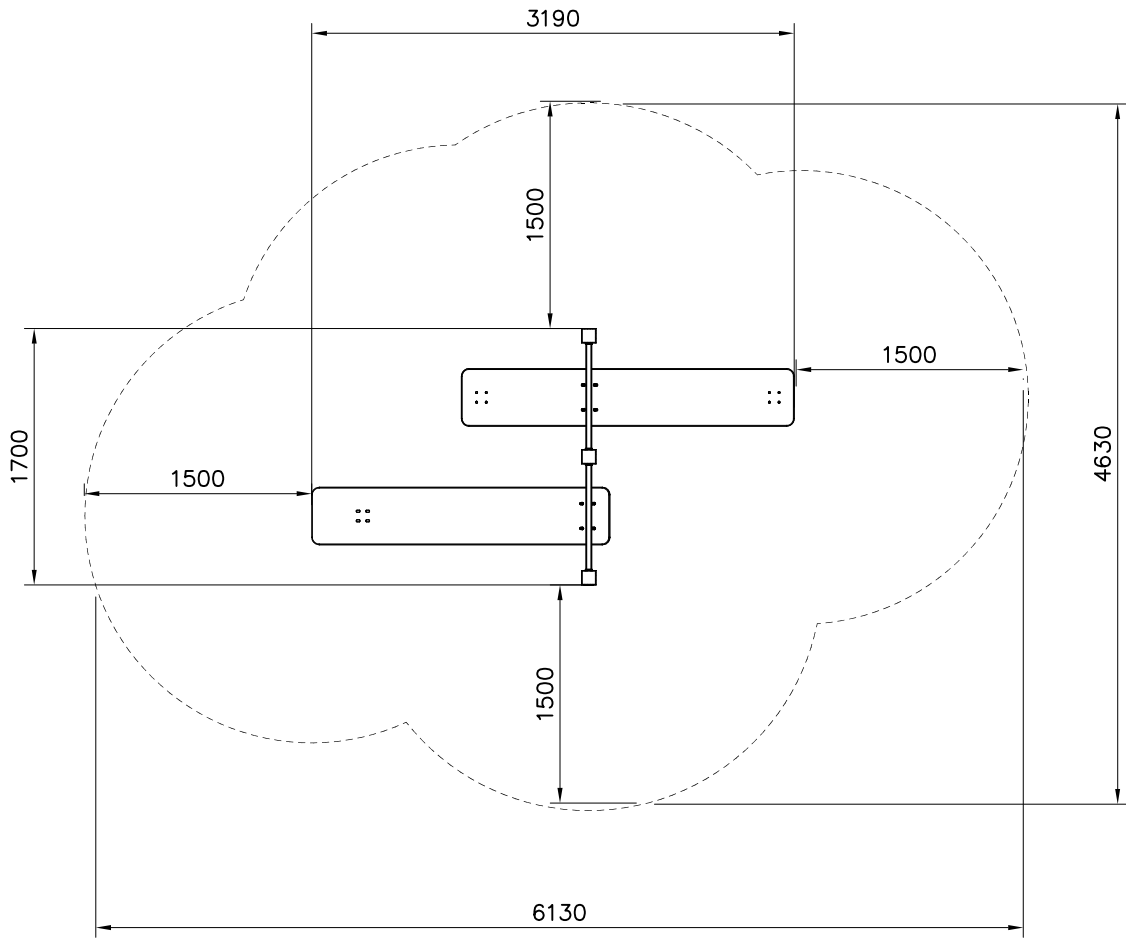
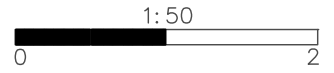

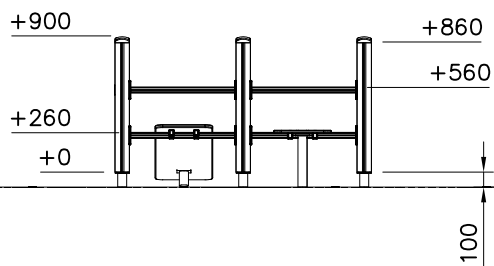
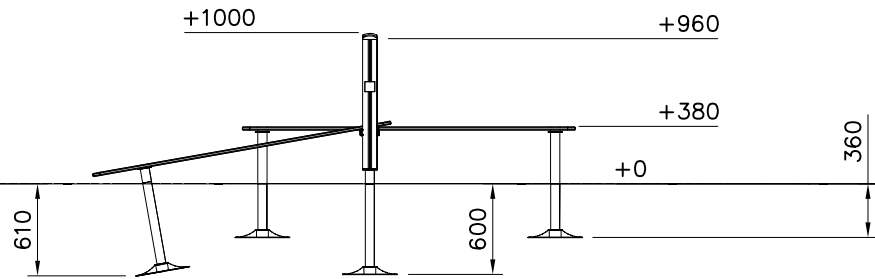

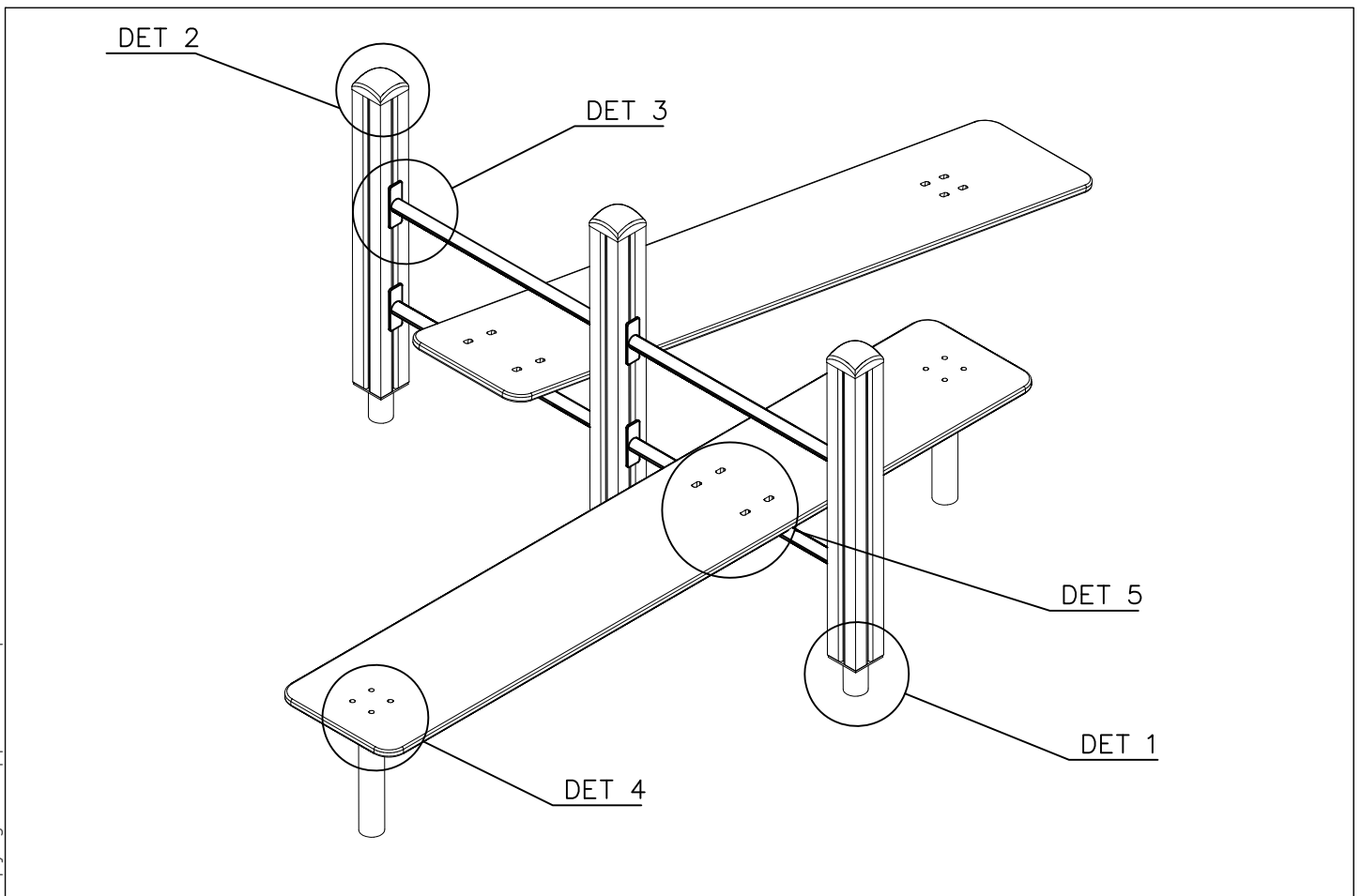
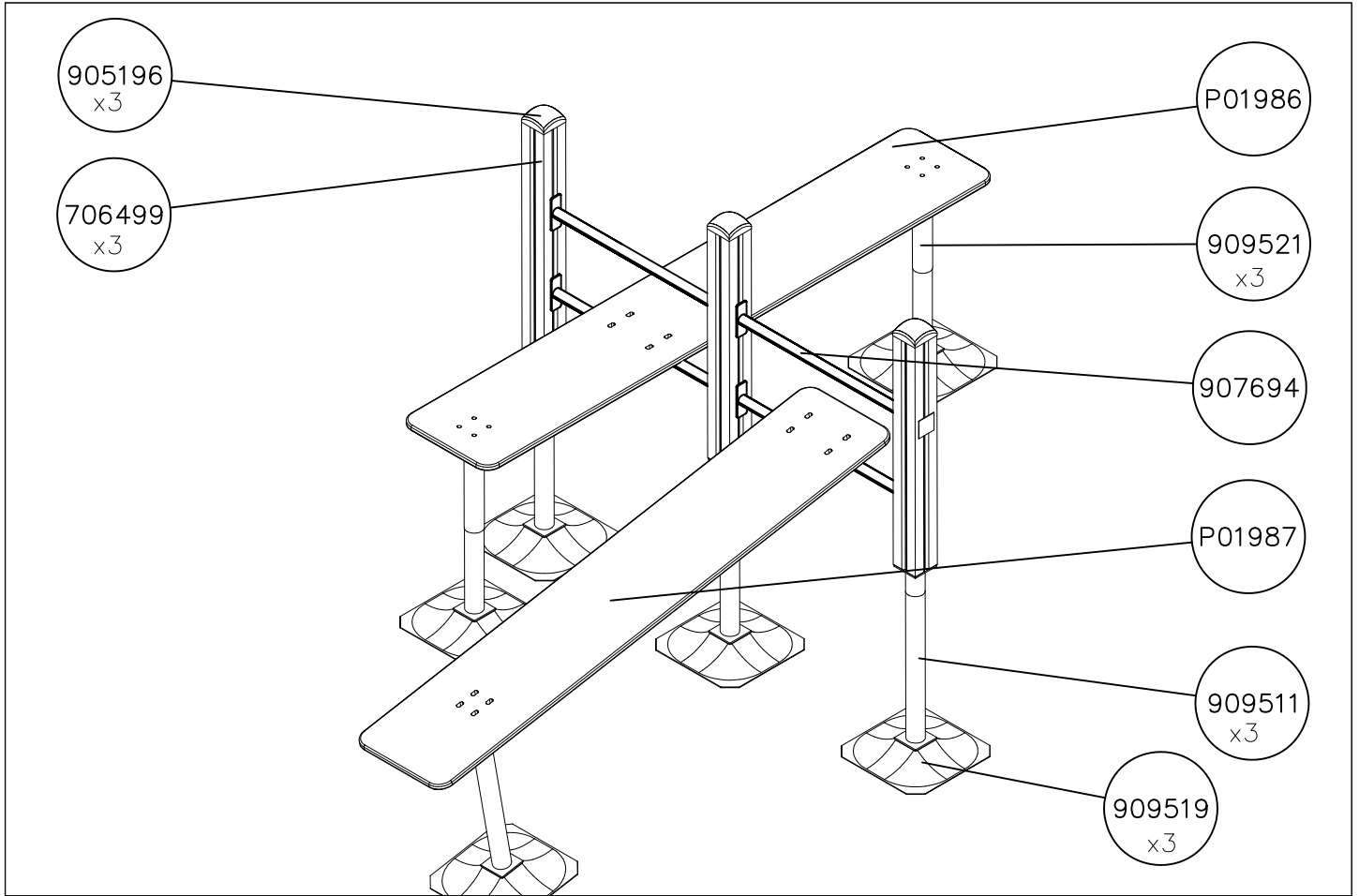

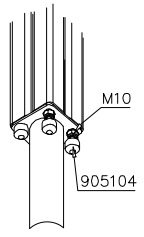
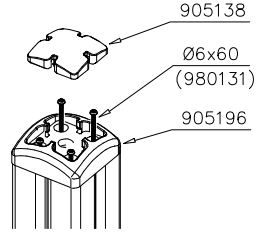
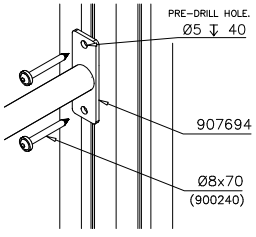
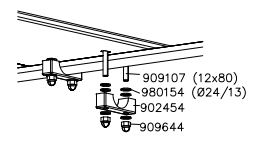
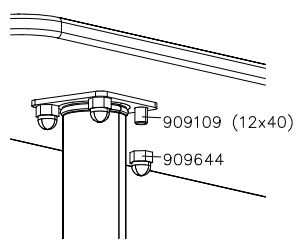
<p>DET 1</p> 	<p>DET 2</p> 	<p>DET 3</p> 	<p>DET 4</p> 
<p>DET 5</p> 			



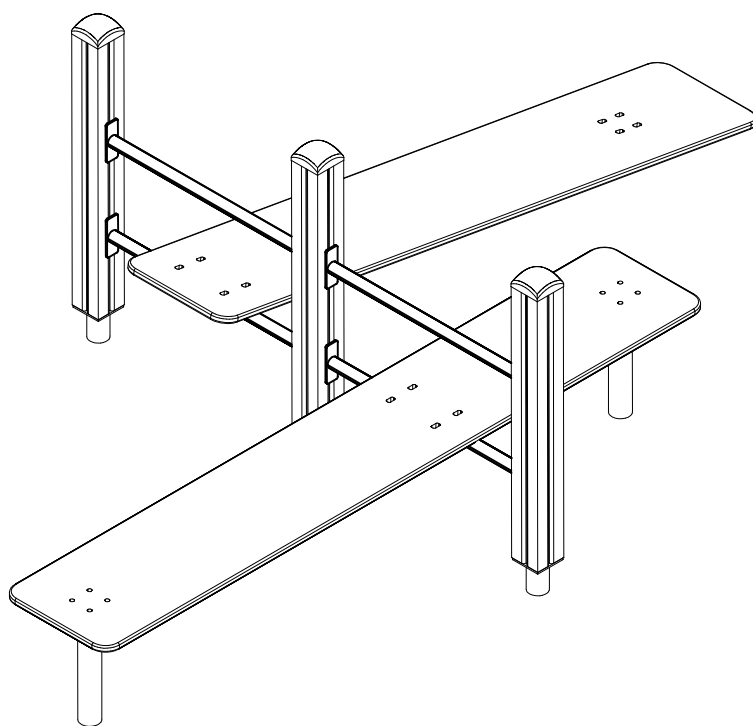
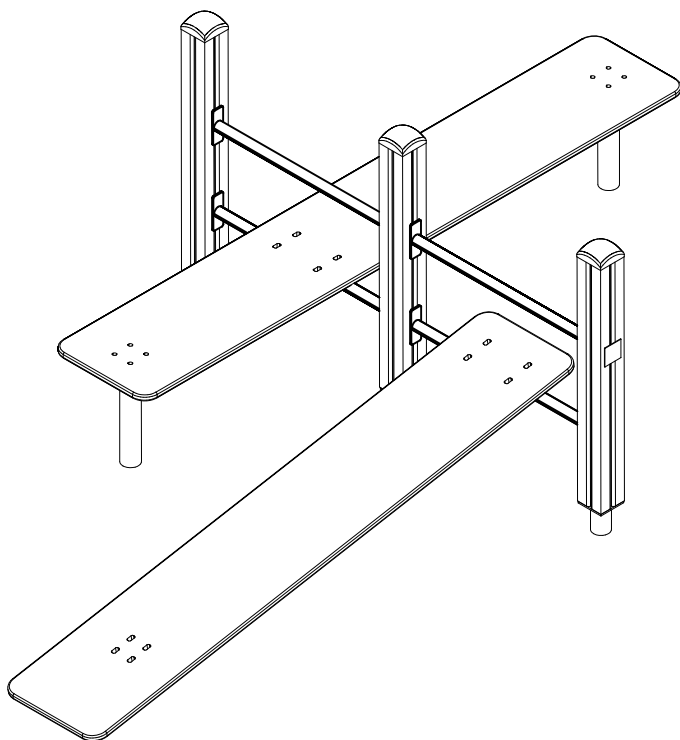

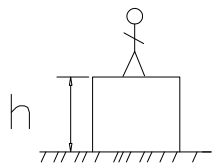

$h < 1000$

Totally hard surfaces or materials with very limited impact attenuating properties.

Totally hard surfaces.  
E.g. concrete or asphalt



Case by case risk assessment is needed including e.g. evaluation whether there is forced movement, what is the intended exercise and where will the product be installed.

Materials with very limited impact attenuating properties.  
E.g. wood

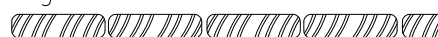

$h < 1200$

Materials with significant impact attenuating properties.

fine gravel 0–8 mm

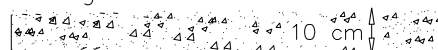

Unsorted sand/ topsoil

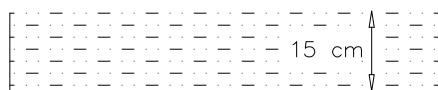

$h < 1500$

Lawn



$h < 3000$

Loose fill material

E.g.  
sand/gravel 0,25...8 mm  $D_{60}/D_{10} < 3,0$   
Woodchips 5...30 mm  
bark 20...80 mm

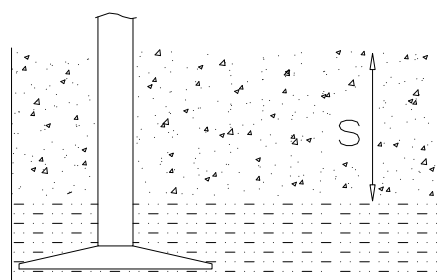

$\underline{S}$	$\underline{h}$
30 cm	$< 2,0 \text{ m}$
40 cm	$< 3,0 \text{ m}$



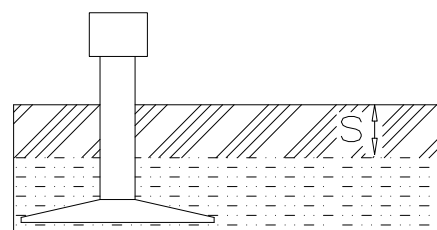

Syntetic granulates

$\underline{S}$	$\underline{h}$
40 mm	$\sim > 1,2...1,3 \text{ m}$
50 mm	$\sim > 1,5...1,7 \text{ m}$
60 mm	$\sim > 1,8...2,0 \text{ m}$
70 mm	$\sim > 2,1...2,5 \text{ m}$

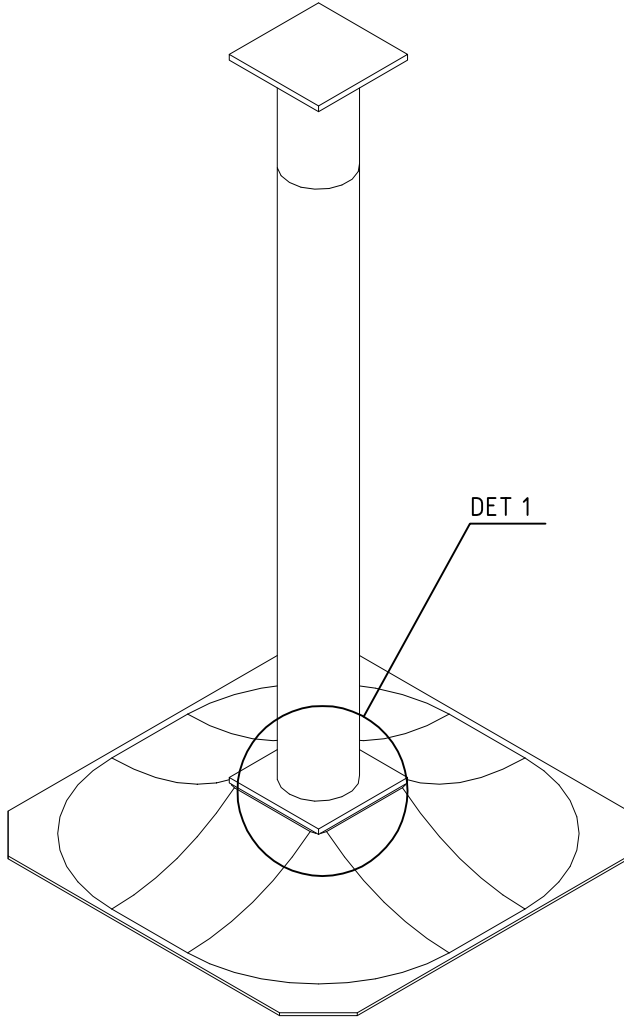

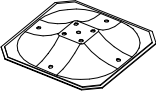
Note. For accurate values, see manufacturer's instructions.



①	909511	PCS	②	909519	PCS
		1			1
③	909637	PCS	④	909638	PCS
		4			8
	M10			Ø20/10.5	
⑤	909639	PCS			PCS
		4			
	M10x25				
		PCS			PCS
		PCS			PCS
		PCS			PCS
		PCS			PCS
		PCS			PCS

DET 1

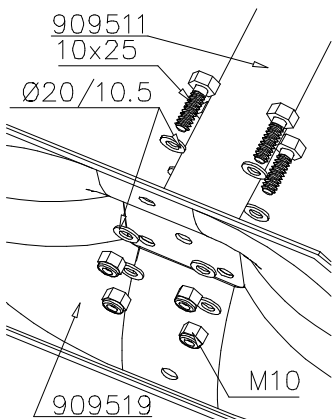

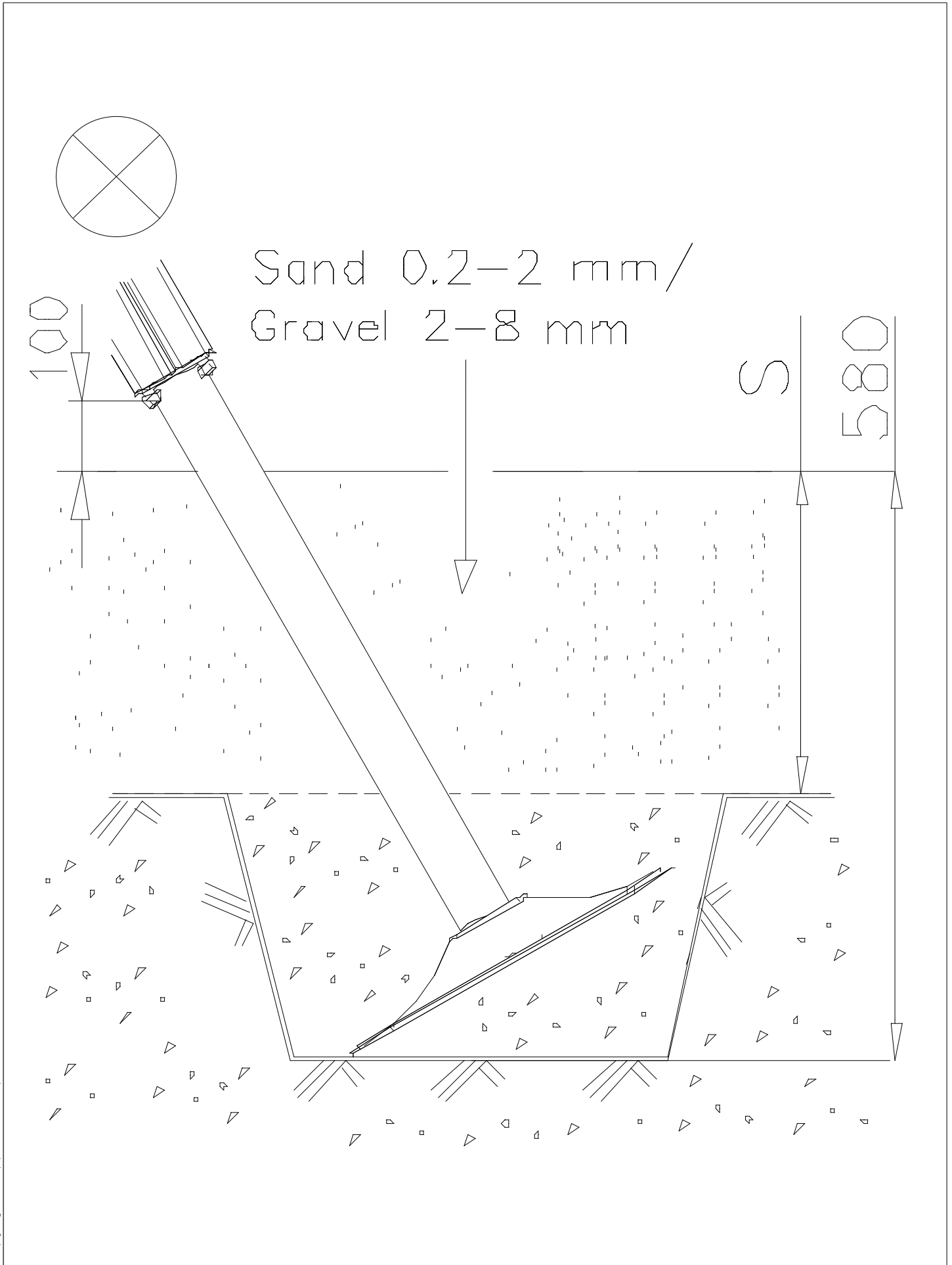



## Tuotekyltti tulee tuotteen mukana yhdellä seuraavista tavoista:

### 1) Metallinen tuotekyltti ja kiinnitysruuvit

- Kiinnitä tuotekyltti ruuveilla tolppaan noin 2 metrin korkeuteen kuvan 1 mukaisesti.

### 2) Tuotekylttitarra

- Puhdista maalattu metalli- tai vaneripinta pölystä ja kosteudesta. Liimaa tarra kuvan 2 mukaisesti.
- Huom. Älä kiinnitä tarraa karheapintaiseen laminaattiin tai maalattuun puuhun.

## Vår produktmärkning levereras på ett av följande sätt:

### 1) Produktskylt i metall

- Fäst skylten med de medföljande skruvarna

### 2) Självhäftande produktetikett

- Rengör den pulverlackerade metallytan eller laminatyten så att den blir fri från smuts och fukt. Fäst etiketten enligt fig. 2.
- Obs! Fäst ej etiketten på detaljer med skrovlig yta eller på målat trä.

## Product label is delivered by one of following ways:

### 1) Metal product label and screws

- Fasten the label with screws.

### 2) Label sticker

- Clean the painted metal or plywood surface from dirt and moisture. Fasten the sticker as shown in the figure 2.
- Note. Do not attach the sticker to rough surfaced laminate or painted wood.

## La plaque d'informations produit est livrée sous l'une de ces 3 formes :

### 1) Plaque métallique et vis

- Fixez la plaque à l'aide des vis.

### 2) Etiquette autocollante

- Avant de coller l'étiquette, nettoyez le composant métallique peint ou la plaque de contreplaqué, de toute saleté. La surface doit être sèche (voir image 2).
- Attention, ne pas coller l'étiquette sur une surface lamellé-collée irrégulière ou sur du bois peint.

## Die Auslieferung des Produktaufklebers erfolgt auf eine dieser Arten:

### 1) Produkt-Schild aus Metall incl. Schrauben

- Die Befestigung des Schildes erfolgt mittels der Schrauben.

### 2) Aufkleber

- Entfernen Sie zunächst Schmutz und Feuchtigkeit vom lackierten Metall bzw. von der Holzoberfläche und bringen Sie den Aufkleber wie im Bild oben rechts beschrieben auf den gesäuberten Untergrund auf.
- Beachten Sie: Bringen Sie den Aufkleber nicht auf raues laminiertes oder lackiertes Holz an.



**LAPPSET®**  
**BETON FOUNDATION**

**FOOT**

DATE: 27.10.2015

**1(1)**

② 905104	PCS		PCS
	4		
 M10	PCS		PCS



905104

# LAPPSET® DEEP FOUNDATION

# FOOT

DATE: 15.5.2018

1(1)



①	909511	PCS	②	909519	PCS
		1			1
	90x90x650			50x380x380	

③	909637	PCS	④	909638	PCS
		4			8
	M10			Ø20/10.5	

⑤	909639	PCS	⑥	905104	PCS
		4			4
	M10x25			M10	

OPTION FOOT

①	911155	PCS			PCS
		1			
	90x90x650				