

# **LAPPSET®**

## **PROMENADE**







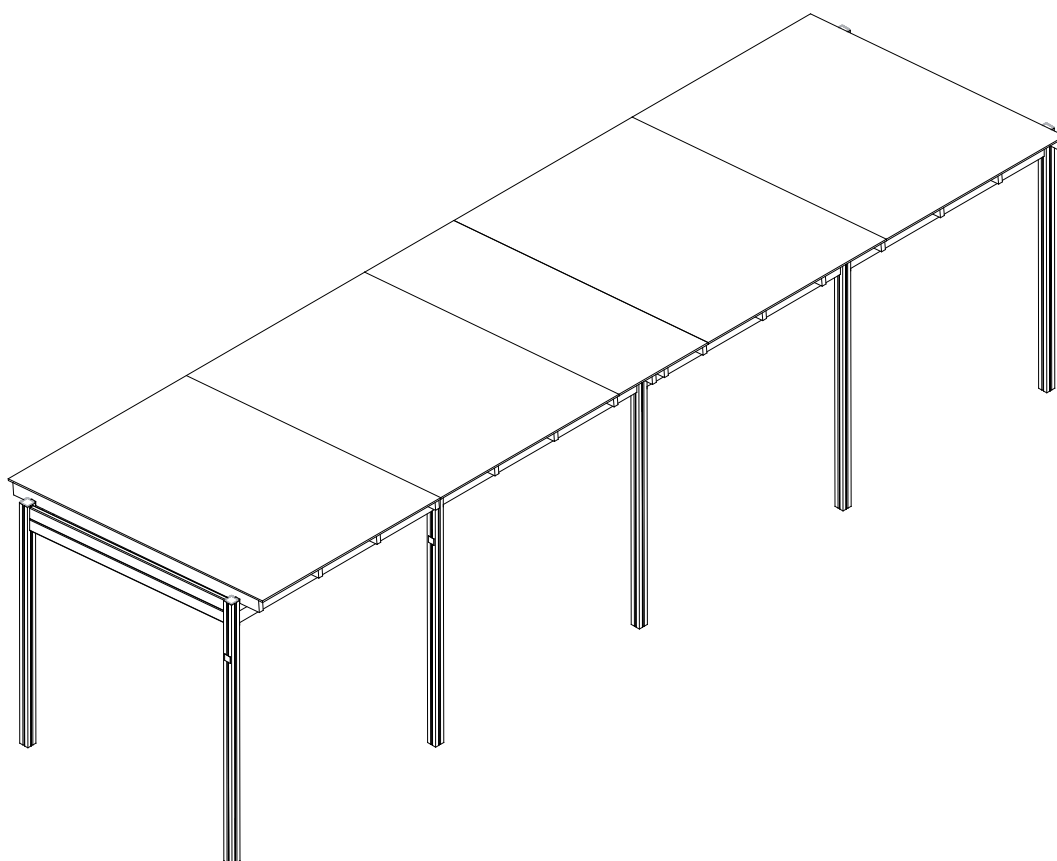

ASENNUSOHJE  
MONTERINGSANSVISNING  
INSTALLATION INSTRUCTION  
AUFBAUANLEITUNG  
NOTICE D'INSTALLATION

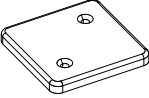
DATE: 24.6.2021

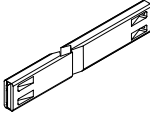
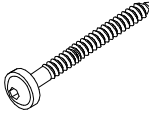
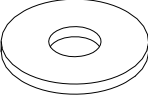
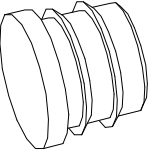
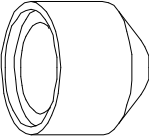
### **Q15590**

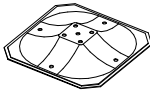
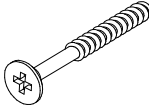
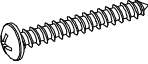
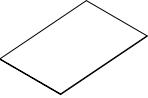

DATE: 24.6.2021

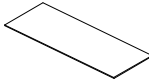
702286  65x65	PCS 2	706481-705  83x83x10	PCS 10	706568-604  93x93x3000	PCS 5	707295-604  L 2304	PCS 16	903093  Ø8x90	PCS 104	905051  Ø24/8.4	PCS 32
905066  S30H	PCS 32	905104  M10	PCS 20	909232  8x120	PCS 32	909519  380x380	PCS 10	980107  Ø6x60	PCS 20	980114  Ø4x20	PCS 8
P05117  16x2100x3000	PCS 4	P10563-604  L 2900	PCS 16	P15312  L 3200	PCS 5	P15316  L-shaped bar	PCS 10	P15471  16x1050x3000	PCS 1		PCS
	PCS		PCS		PCS		PCS		PCS		PCS
	PCS		PCS		PCS		PCS		PCS		PCS
	PCS		PCS		PCS		PCS		PCS		PCS
	PCS		PCS		PCS		PCS		PCS		PCS

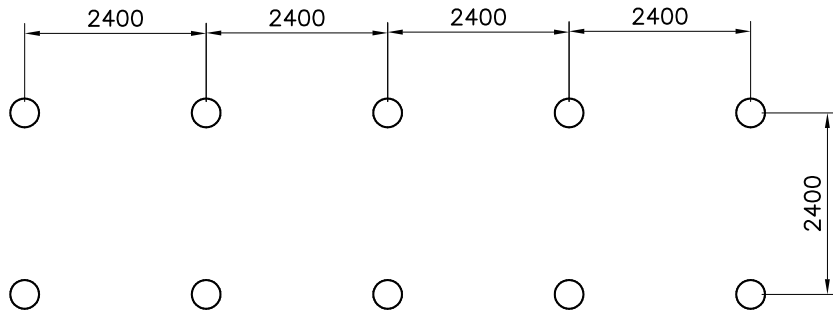

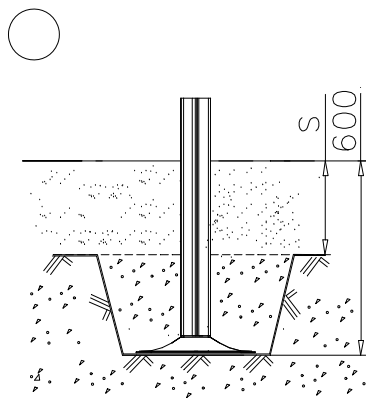
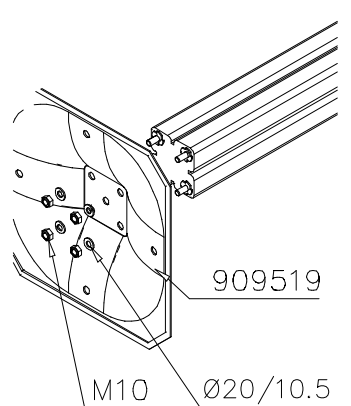
 <p>A cross-sectional diagram of a drainage channel. A vertical pipe is shown in the center. The channel walls are sloped, with the slope indicated by the letter 'S'. A dimension line on the right indicates a height of 600. The channel is filled with a granular material, likely gravel or sand, and is shown installed in a concrete base.</p>	 <p>A technical drawing of a drainage grate assembly. It shows a grate with a grid pattern and a frame. The frame is secured with screws. Labels include '909519' pointing to the grate, 'M10' pointing to a screw, and 'Ø20/10.5' pointing to a hole in the frame.</p>	

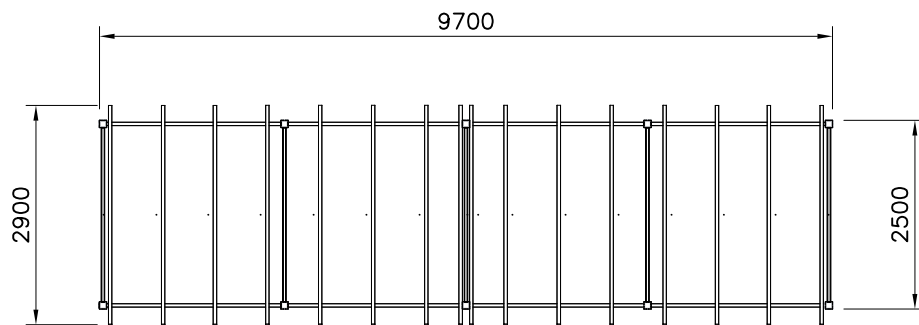

1:75

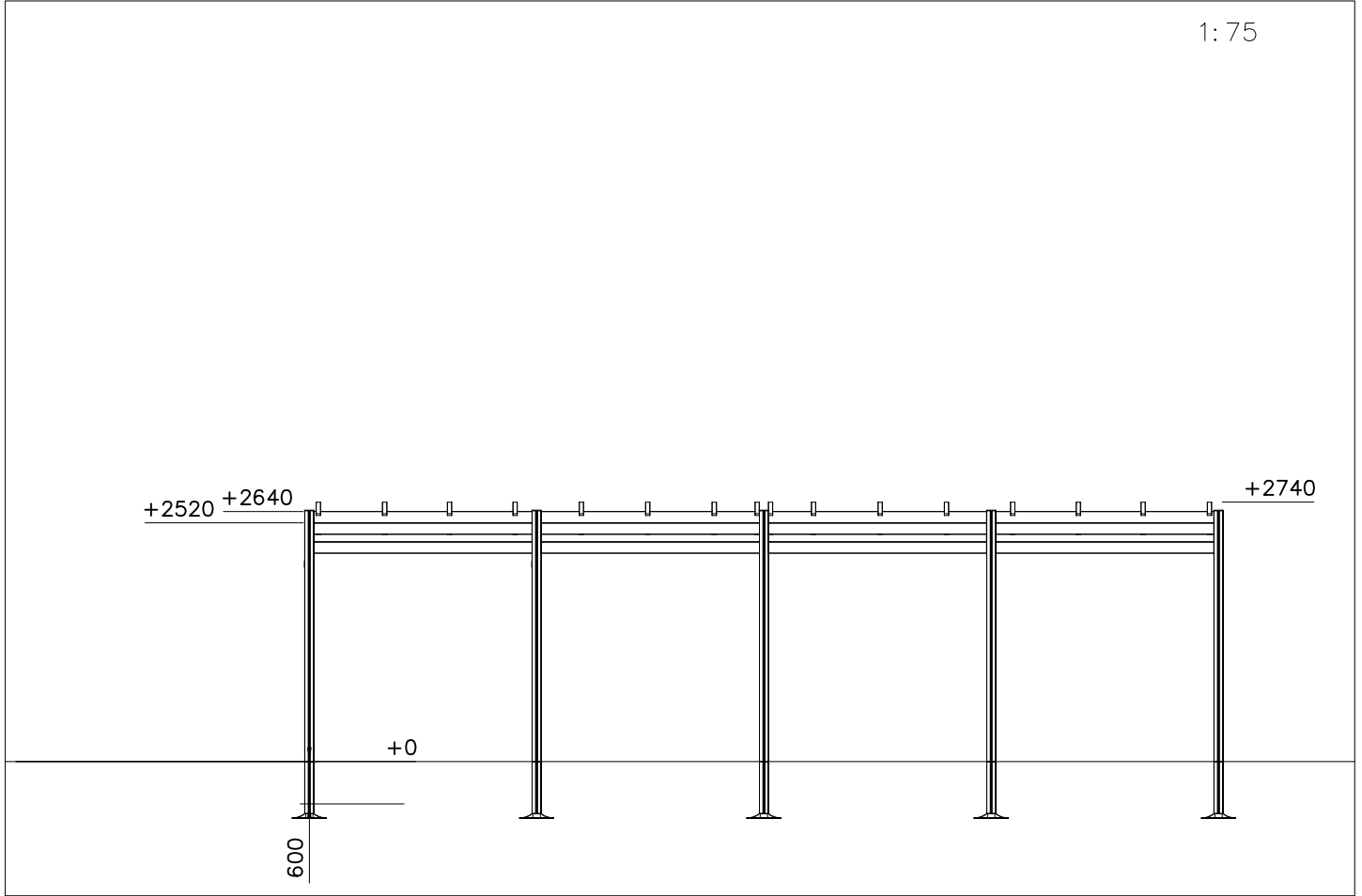

1:50

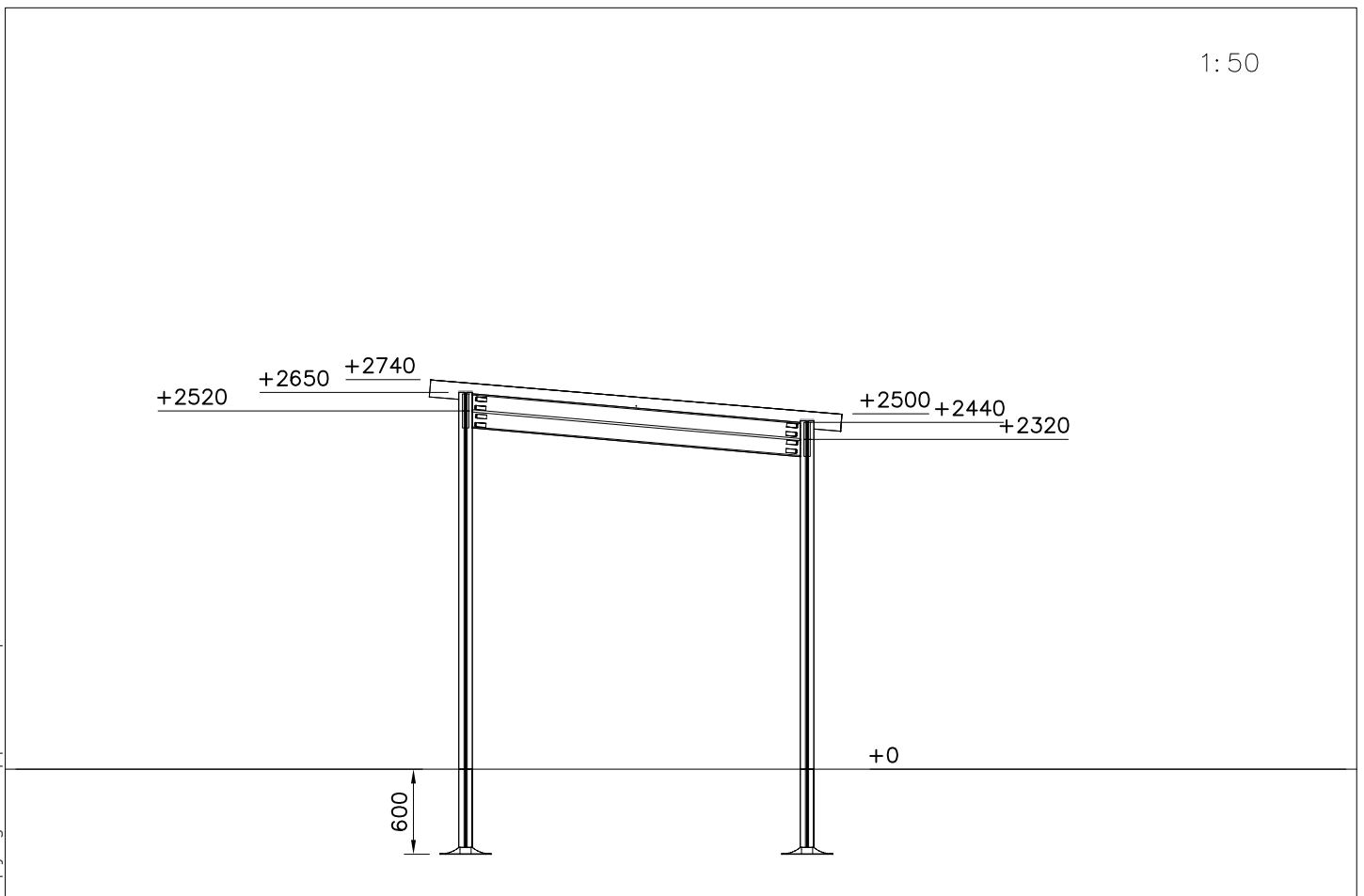

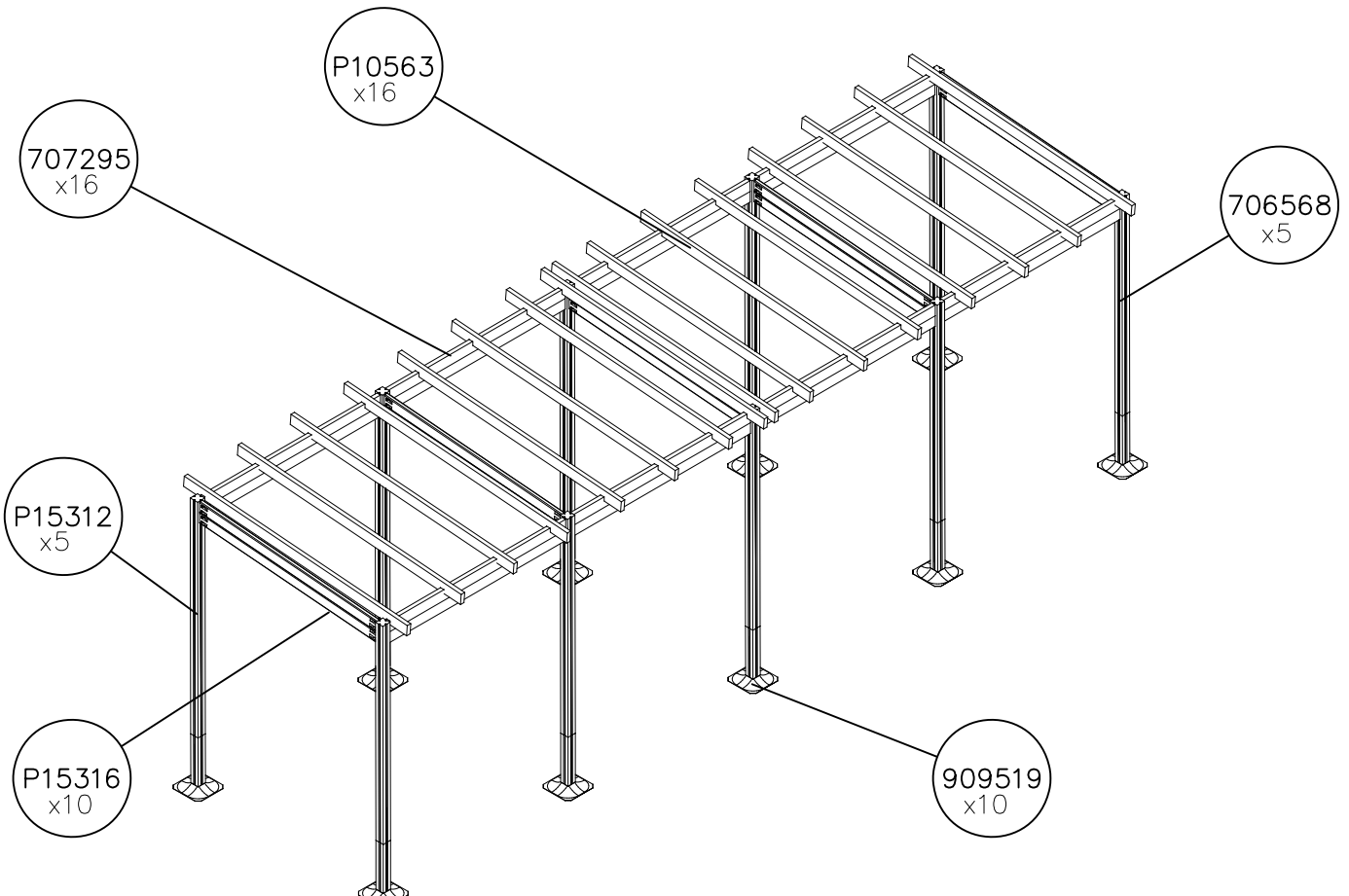
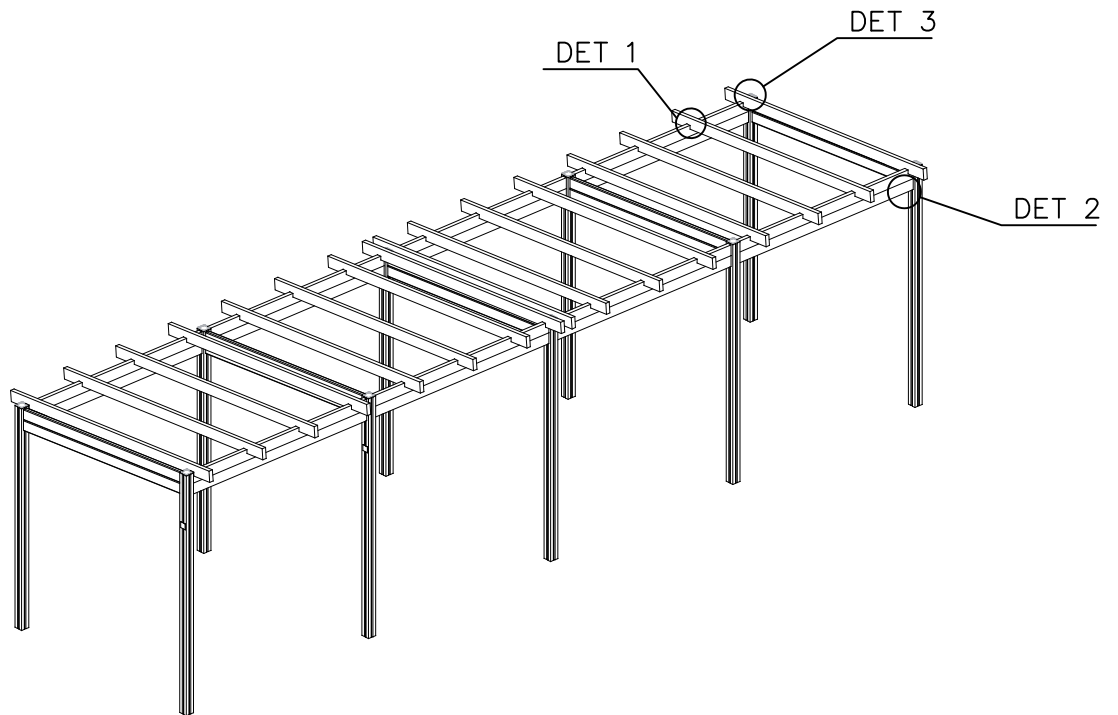

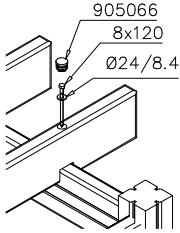
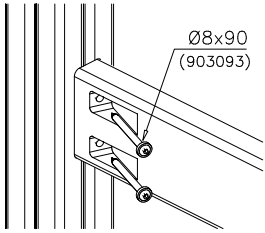
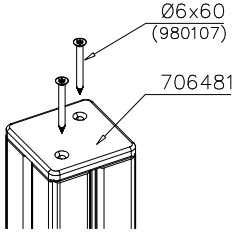
DET 1	DET 2	DET 3	
			



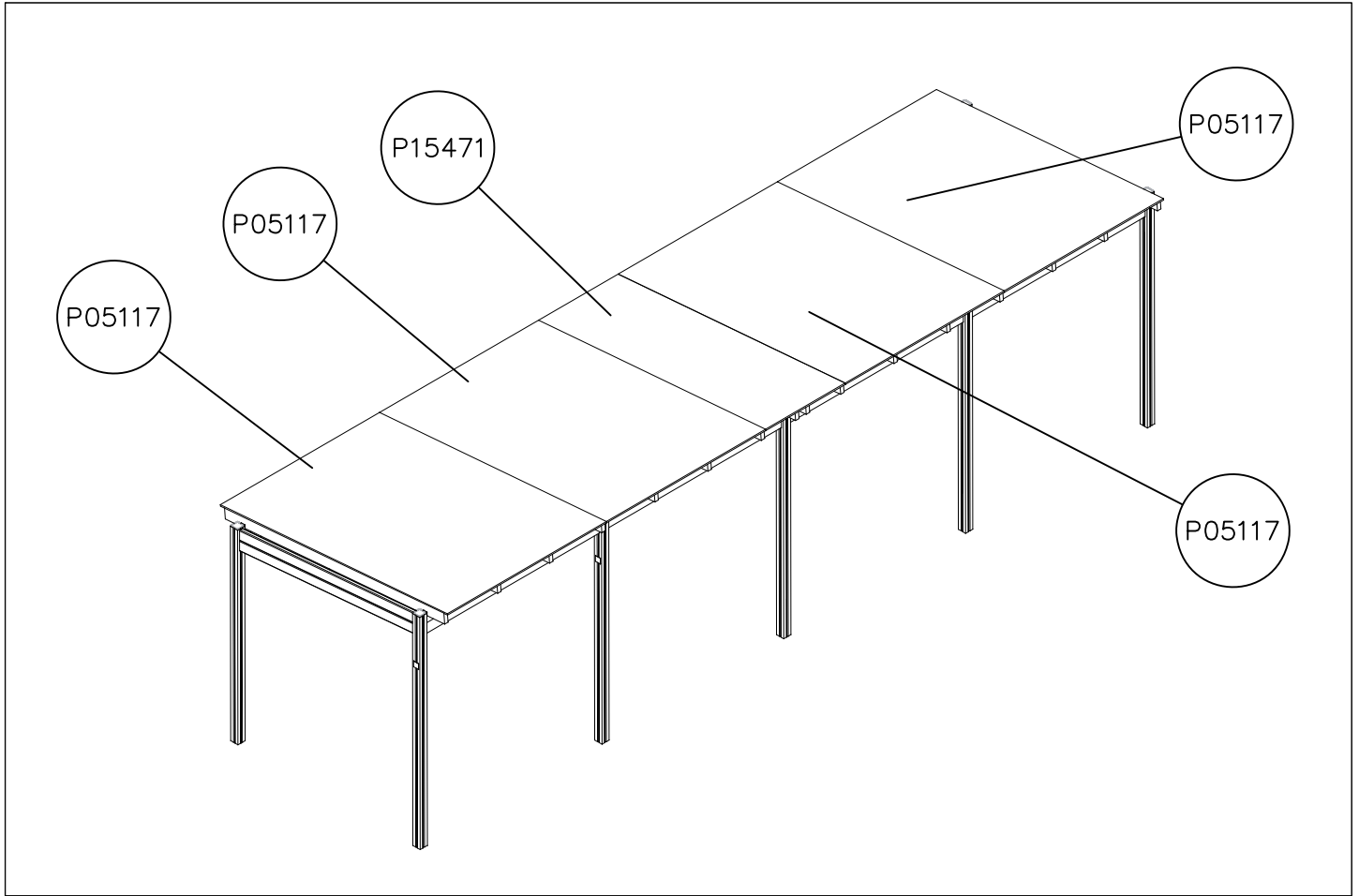

Beam(P10563) gaps are directive,  
 final distances according to the  
 polycarbonate plates.

1:75

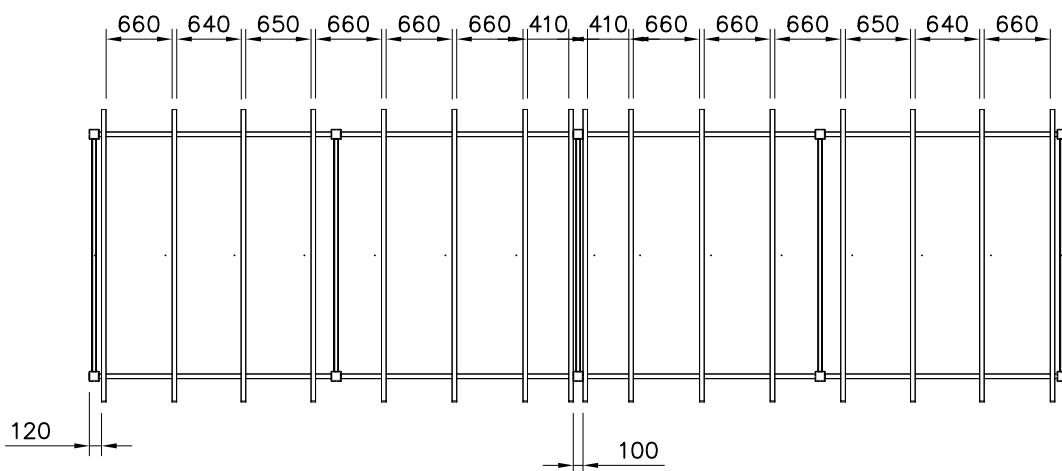

# PC- kerroslevyt

## Kylmät tilat -asennus PC-muovisin H-listoin

PC-kerroslevyistä voi H-listojen avulla helposti rakentaa tasomaisen valokatteen. Katteisiin soveltuvat 10 ja 16 mm paksuiset levyt.

**Huom! Asennus H-listan kanssa onnistuu parhaiten max. 3,5 m pituisilla levyillä.**

Asennus tapahtuu vaakaruoteiden päälle. Yleensä valokate päättyy ala- ja sivureunoilla alumiinisiin päätyprofiileihin. Kate ylittää ruoderungon vähintään 35 mm

H-listat saattavat kerätä likaa ilman epäpuhtauksista. Alumiinisilla valokatelistoilla asennettuna sauma pysyy puhtaampana.

Asennustapa PC-H

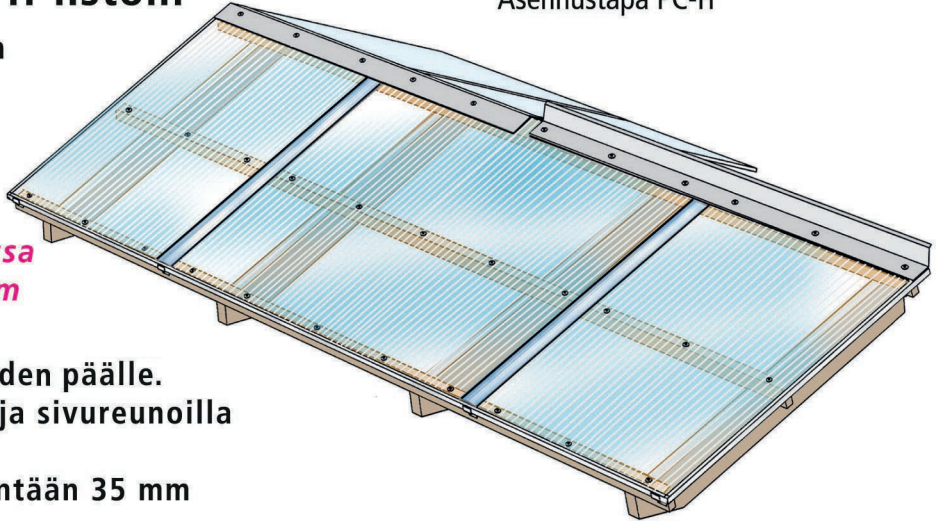



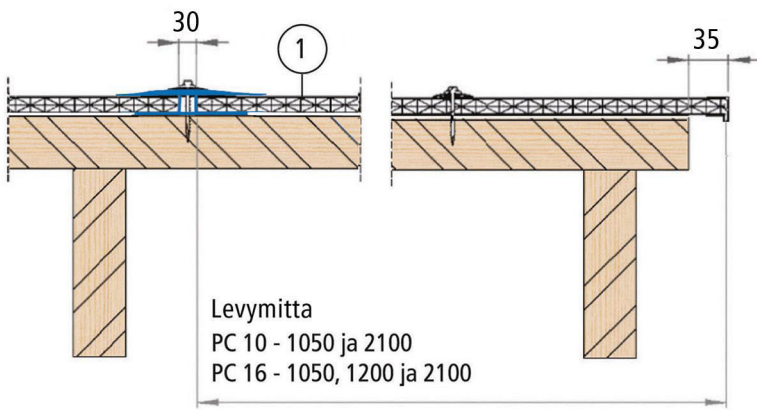

Levyymitta  
 PC 10 - 1050 ja 2100  
 PC 16 - 1050, 1200 ja 2100

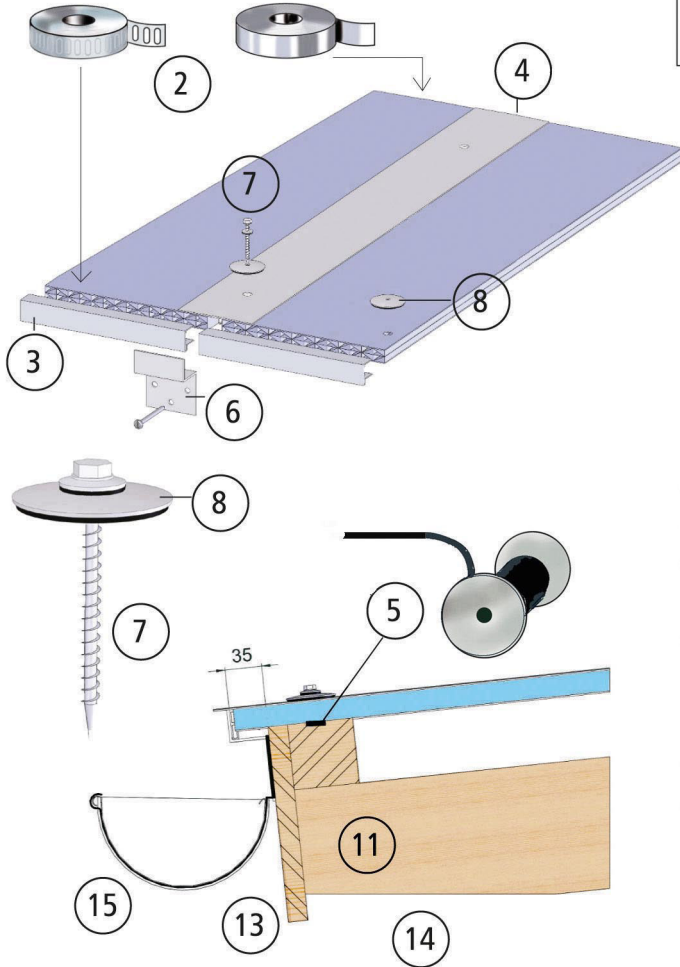
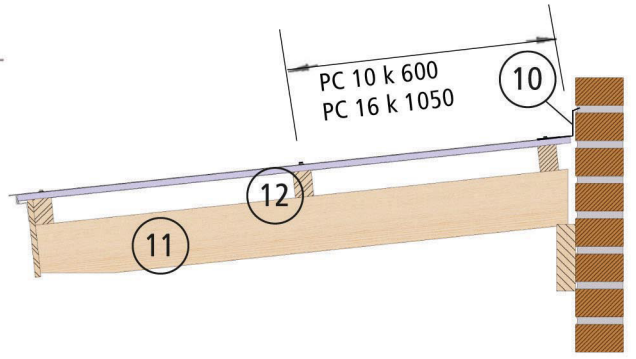

## Kylmät tilat - asennus H-listoin

1. PC-monikerroslevy  
 paks. 10 mm, leveys 1050 ja 2100 mm  
 paks. 16 mm, leveys 1050, 1200 ja 2100 mm
2. Suodatinteippi alareunaan ja alumiiniteippi yläreunaan
3. Päätelista, U-profiili, alumiinia, ala- ja sivureunoille
4. H-lista levyjen saumoissa, alapään sahaus muotoiltu ks. kuva
5. Vaakatiiviste 9 x 3 mm ruoteeseen nitoon
6. Z-toppari levysaumojen kohdalle ja metrin välein
7. Kateruuvi RST 4,8 x 50...60 mm, ylä- ja alareunassa k 500, loput tasaisesti 4-6 kpl / m<sup>2</sup>, esireikä 8 mm
8. Aluslevy ø 38 mm, 4-6 kpl / m<sup>2</sup>
10. Vesipelti, seinäliittymä 70 x 115 mm, RR 21
11. Kattokannattajat rakennesuunnitelman mukaan
12. Vaakaruoteet esim. 45 x 70, k 600...1050 mm
13. Otsalauta
14. Runko, perustus ja lattia rakennesuunnitelman mukaan
15. Mahdollinen räystäskouru

**Huom!**  
 Levyt asennetaan siten, että painatuskuviot tulee ylös- / ulospäin (UV-suojaus)

## Muovilevyjen käsittelyohjeet



Levynipun säilytys sisällä tai hyvin peitettynä varjossa

Käytä erikoisporia



Liiku varovasti muovikatteen päällä. Käytä apuvälineinä vaahтомуovilla pehmustettuja lankkuja tai lapetikkaita

+5 °C

Suosittelava minimi lämpötila muovilevyjen asennuksessa

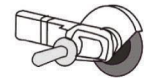

Paloittelu ohuella katkaisulaikalla

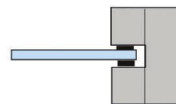

Muista lämpöliikunta 5 mm / m



Pesu runsaalla vedellä ja pehmeällä liinalla. Suositeltava pesuaine Fairy



**Tuotekyltti tulee tuotteen mukana yhdellä seuraavista tavoista:**

**1) Metallinen tuotekyltti ja kiinnitysruuvit**

- Kiinnitä tuotekyltti ruuveilla tolppaan noin 2 metrin korkeuteen kuvan 1 mukaisesti.

**2) Tuotekylttitarra**

- Puhdista maalattu metalli- tai vaneripinta pölystä ja kosteudesta. Liimaa tarra kuvan 2 mukaisesti.
- Huom. Älä kiinnitä tarraa karheapintaiseen laminaattiin tai maalattuun puuhun.

**Vår produktmärkning levereras på ett av följande sätt:**

**1) Produktskylt i metall**

- Fäst skylten med de medföljande skruvarna

**2) Självhäftande produktetikett**

- Rengör den pulverlackerade metallytan eller laminatyten så att den blir fri från smuts och fukt. Fäst etiketten enligt fig. 2.
- Obs! Fäst ej etiketten på detaljer med skrovlig yta eller på målat trä.

**Product label is delivered by one of following ways:**

**1) Metal product label and screws**

- Fasten the label with screws.

**2) Label sticker**

- Clean the painted metal or plywood surface from dirt and moisture. Fasten the sticker as shown in the figure 2.
- Note. Do not attach the sticker to rough surfaced laminate or painted wood.

**La plaque d'informations produit est livrée sous l'une de ces 3 formes :**

**1) Plaque métallique et vis**

- Fixez la plaque à l'aide des vis.

**2) Etiquette autocollante**

- Avant de coller l'étiquette, nettoyez le composant métallique peint ou la plaque de contreplaqué, de toute saleté. La surface doit être sèche (voir image 2).
- Attention, ne pas coller l'étiquette sur une surface lamellé-collée irrégulière ou sur du bois peint.

**Die Auslieferung des Produktaufklebers erfolgt auf eine dieser Arten:**

**1) Produkt-Schild aus Metall incl. Schrauben**

- Die Befestigung des Schildes erfolgt mittels der Schrauben.

**2) Aufkleber**

- Entfernen Sie zunächst Schmutz und Feuchtigkeit vom lackierten Metall bzw. von der Holzoberfläche und bringen Sie den Aufkleber wie im Bild oben rechts beschrieben auf den gesäuberten Untergrund auf.
- Beachten Sie: Bringen Sie den Aufkleber nicht auf raues laminiertes oder lackiertes Holz an.

**LAPPSET®**  
**BETON FOUNDATION**

**FOOT**

DATE: 27.10.2015

**1(1)**

② 905104	PCS		PCS
	4		
 M10	PCS		PCS



905104