

LAPPSET®

THEME







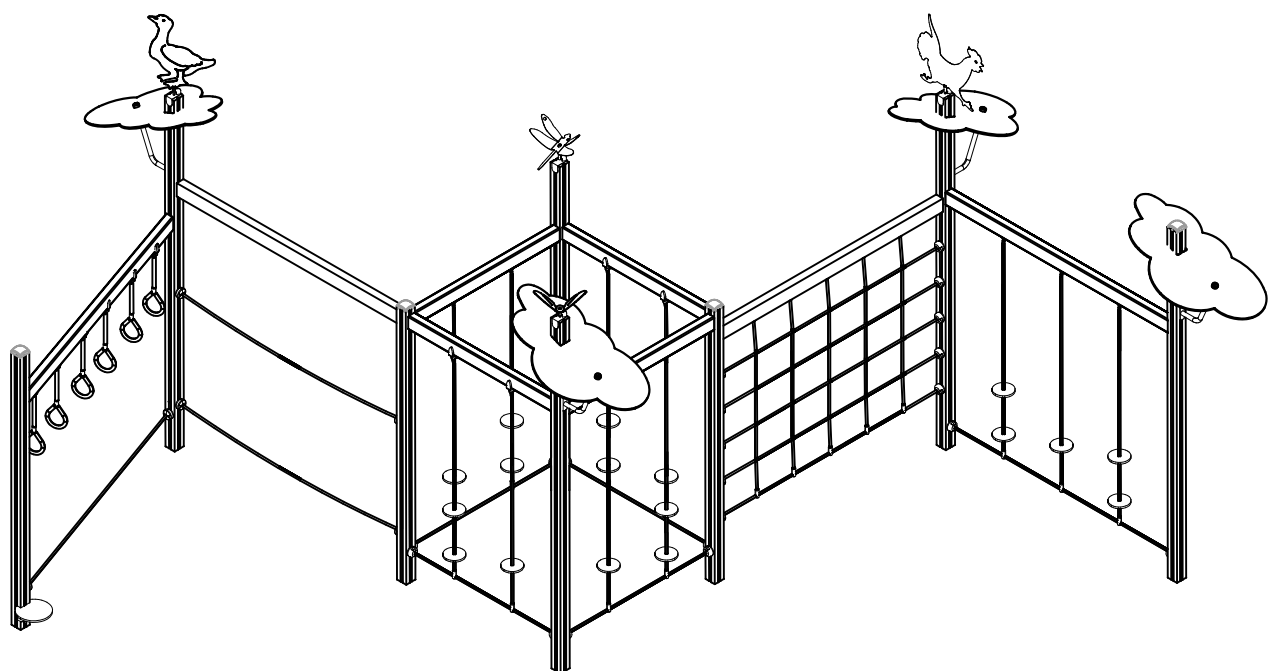



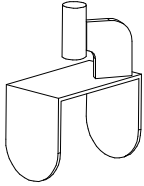

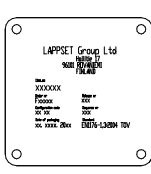
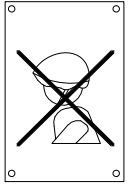
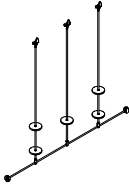
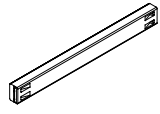
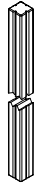
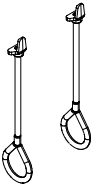
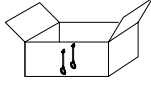

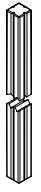
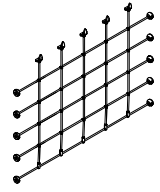
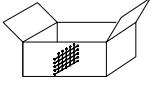
A SENNUSOHJE
MONTERINGSANSVISNING
INSTALLATION INSTRUCTION
AUFBAUANLEITUNG
NOTICE D'INSTALLATION

DATE: 27.4.2021

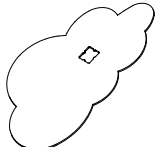
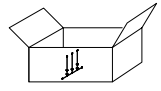
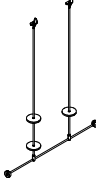
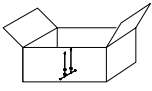
Q15447

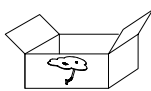
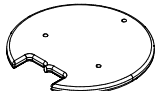
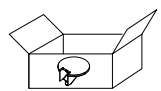
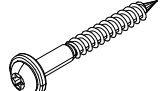
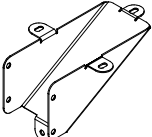
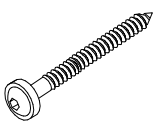
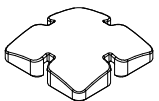
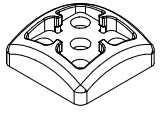
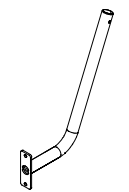
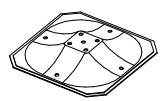
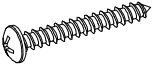
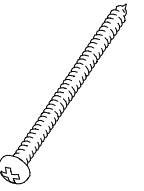

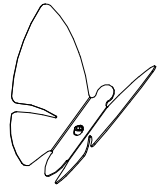
DATE: 27.4.2021

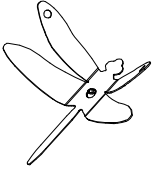
003894  4 	PCS	702286  65x65	PCS	702339  118x78	PCS	704917-305  1	PCS	706514-602  70x120x1504	PCS	706568-602  93x93x3000	PCS
706735-305  3	PCS	706742 	PCS	706788-602  93x93x3700	PCS	706790-602  93x93x3500	PCS	707285-305  1600x2305	PCS	707287  	PCS
707288-305  L 2305 2	PCS	707294-602  70x120x2304	PCS	707328-707  10x750x1290	PCS	707455 	PCS	707456-305  1505x2000	PCS	707458 	PCS
707502-602  70x120x2464	PCS	707665 	PCS	707696-704  15x265x275	PCS	707729 	PCS	900240  Ø8x70	PCS	902086  148x172x254	PCS
903093  Ø8x90	PCS	905138  GRAY	PCS	905196  GRAY	PCS	908207-216  336x392x40	PCS	909519  380x380	PCS	980114  Ø4x20	PCS
980131  Ø6x60	PCS	P01143 	PCS	P10558-305  Ø16x2435	PCS	PN0024  ORANGE	PCS	PO0024 	PCS	PP0309 	PCS
	PCS		PCS		PCS		PCS		PCS		PCS

EN/AS Impact Area 48.4 m²

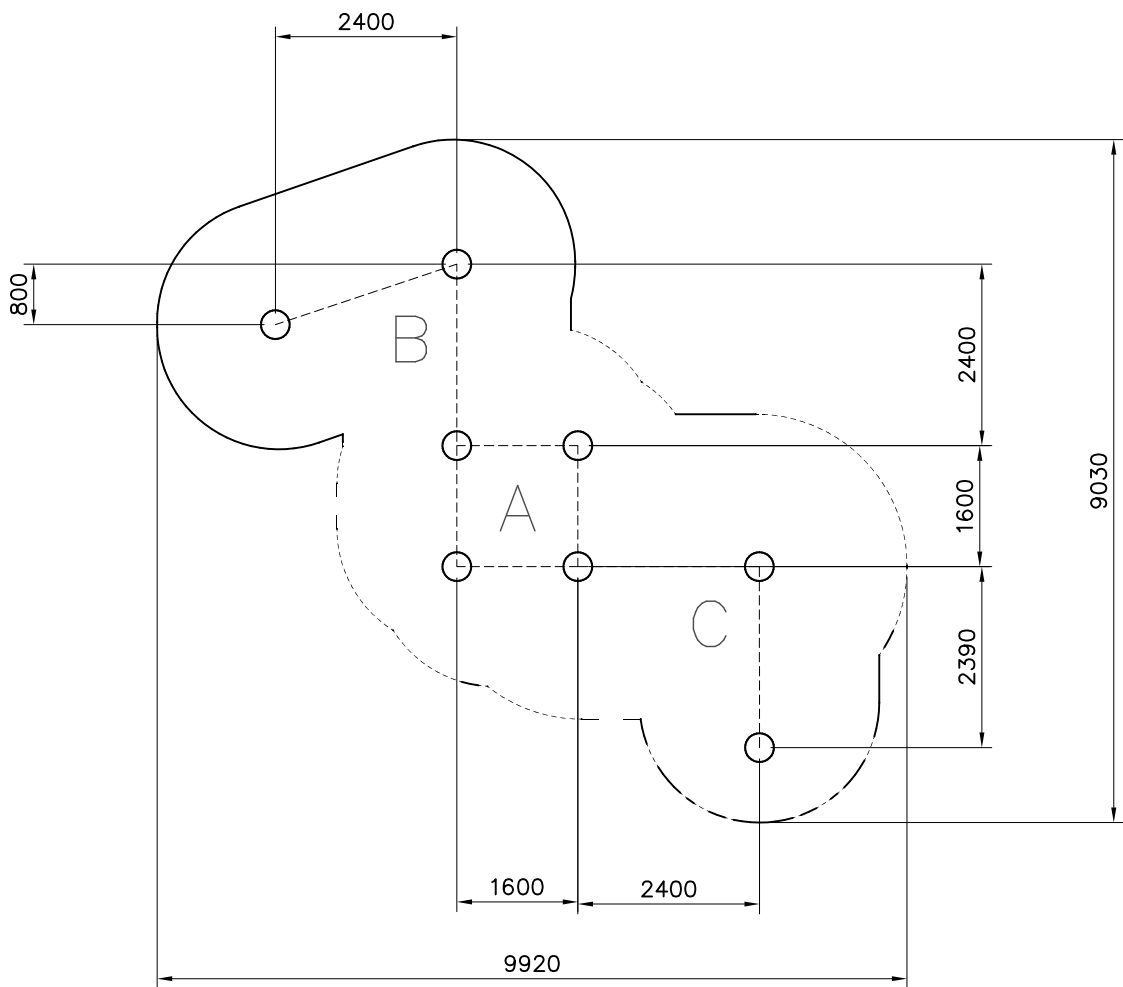

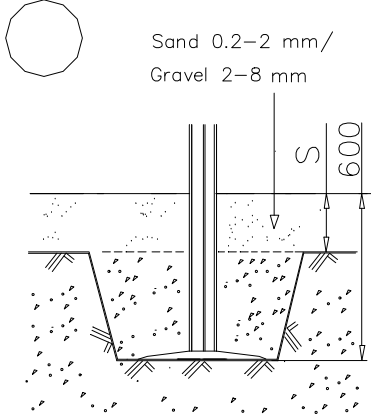
 <p>Sand 0.2-2 mm/ Gravel 2-8 mm</p> <p>600</p>		

- EN/AS Impact Area 48.4 m²
- - - Falling Space 48.4 m²
Max Falling Height 2250 mm

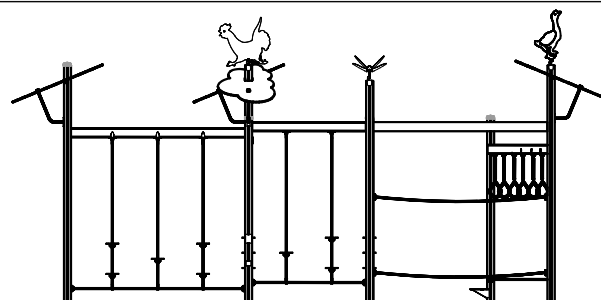
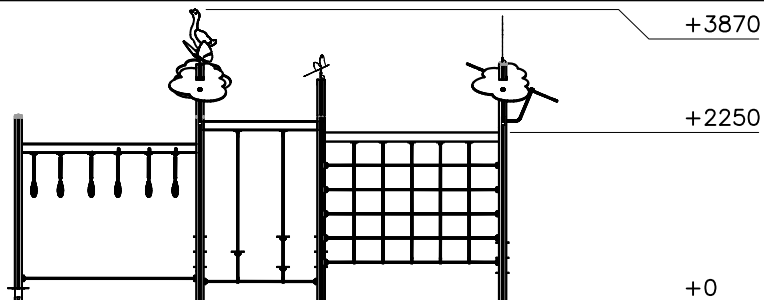
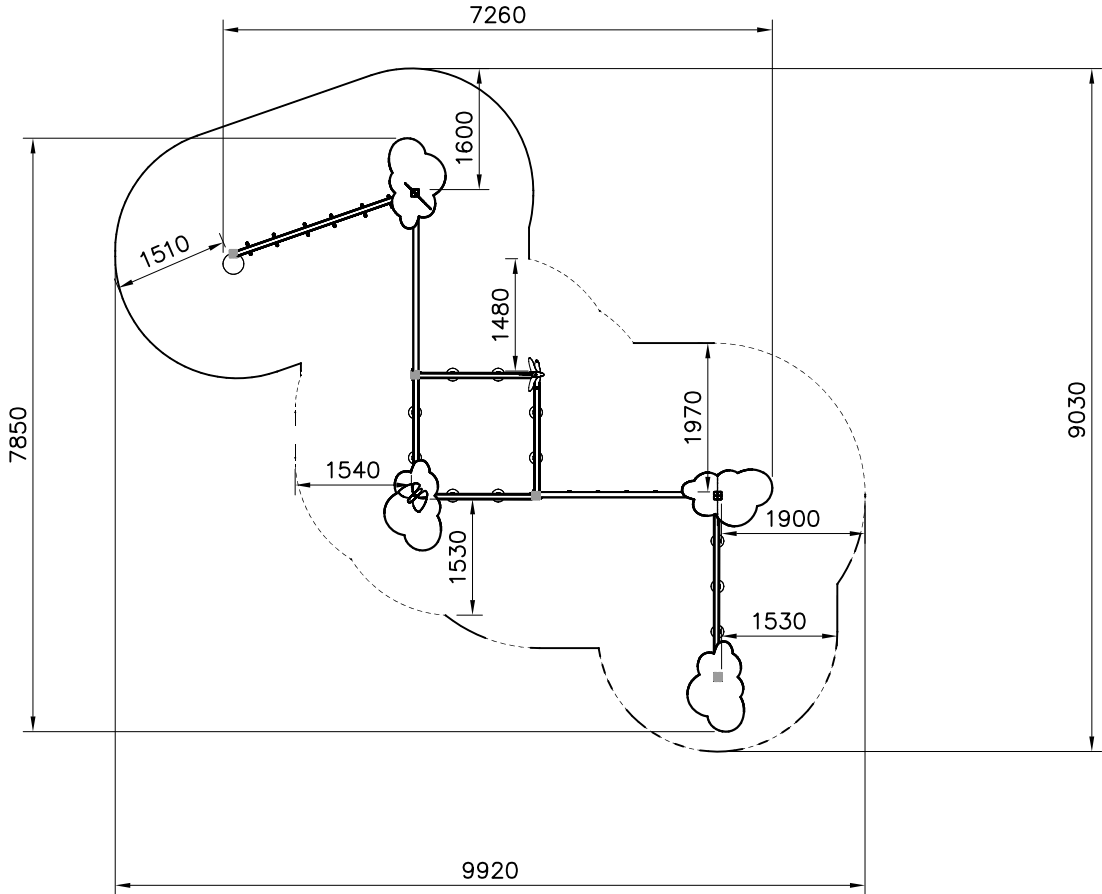

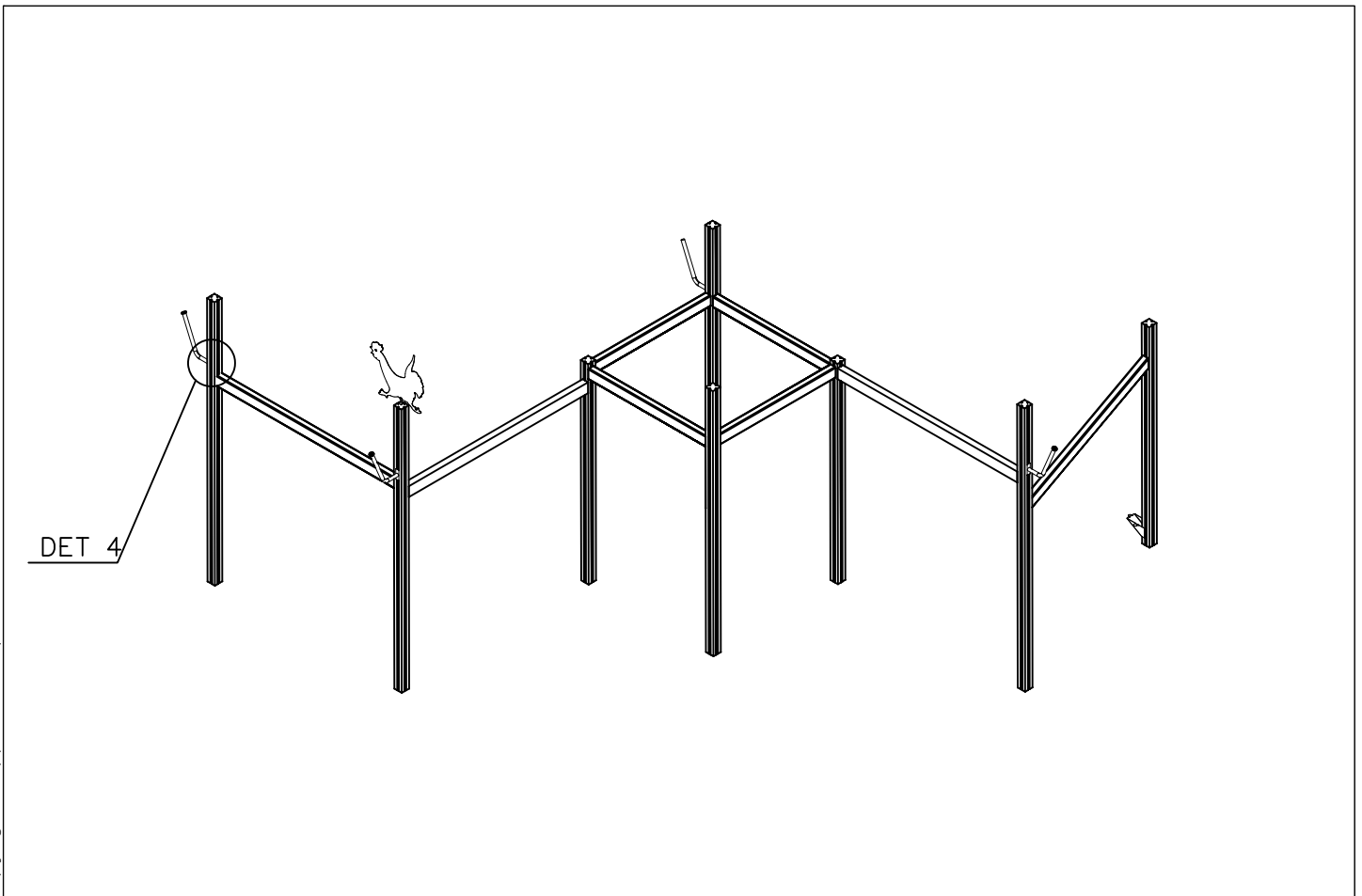
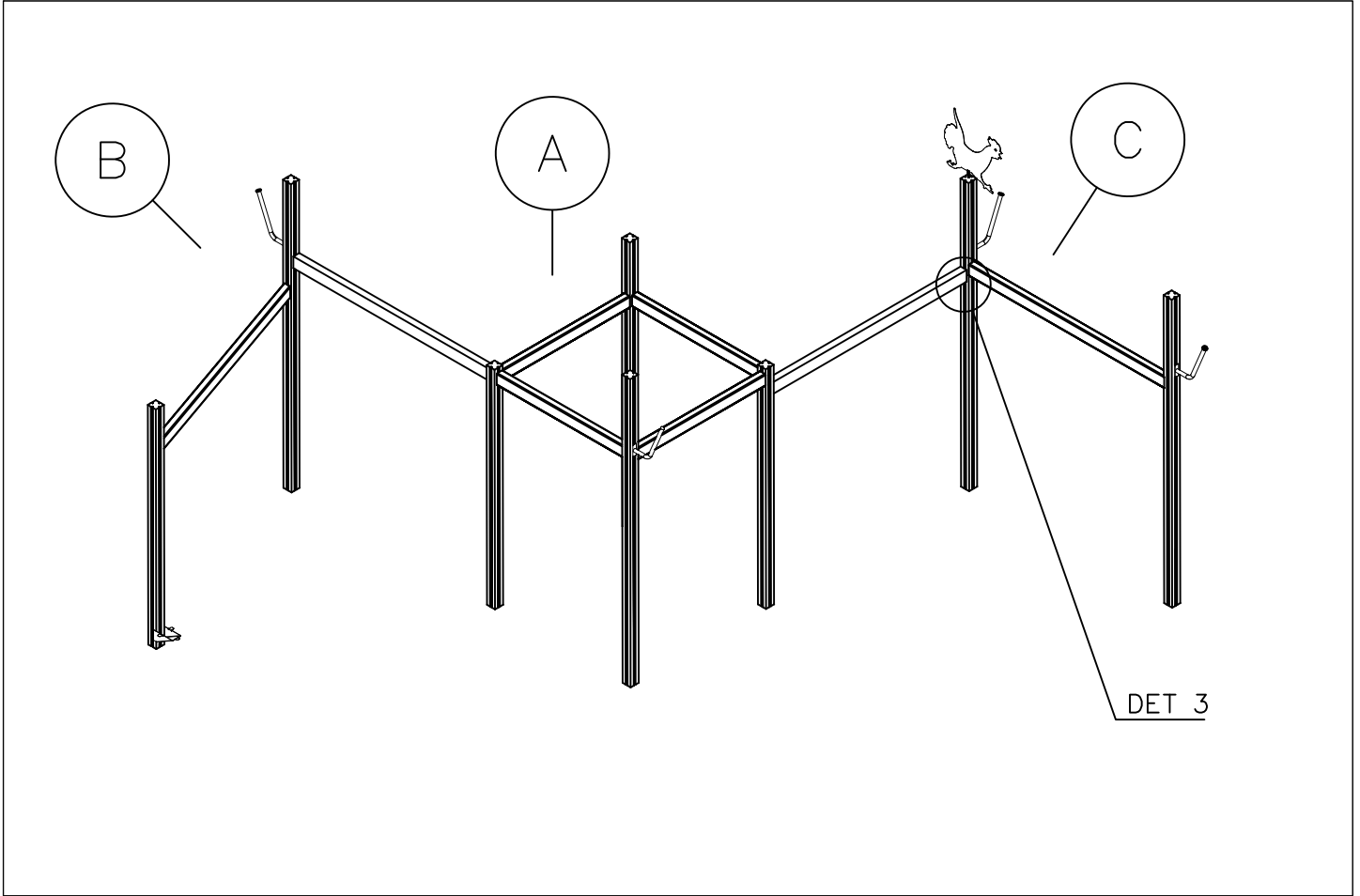

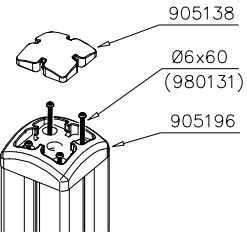
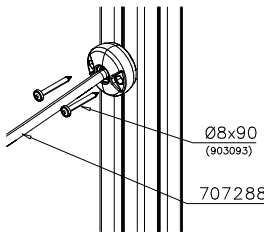
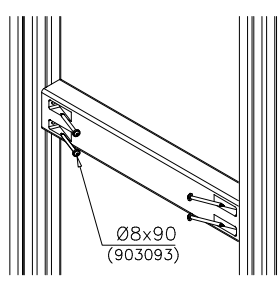
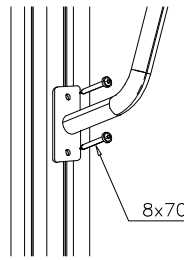
DET 1	DET 2	DET 3	DET 4
			

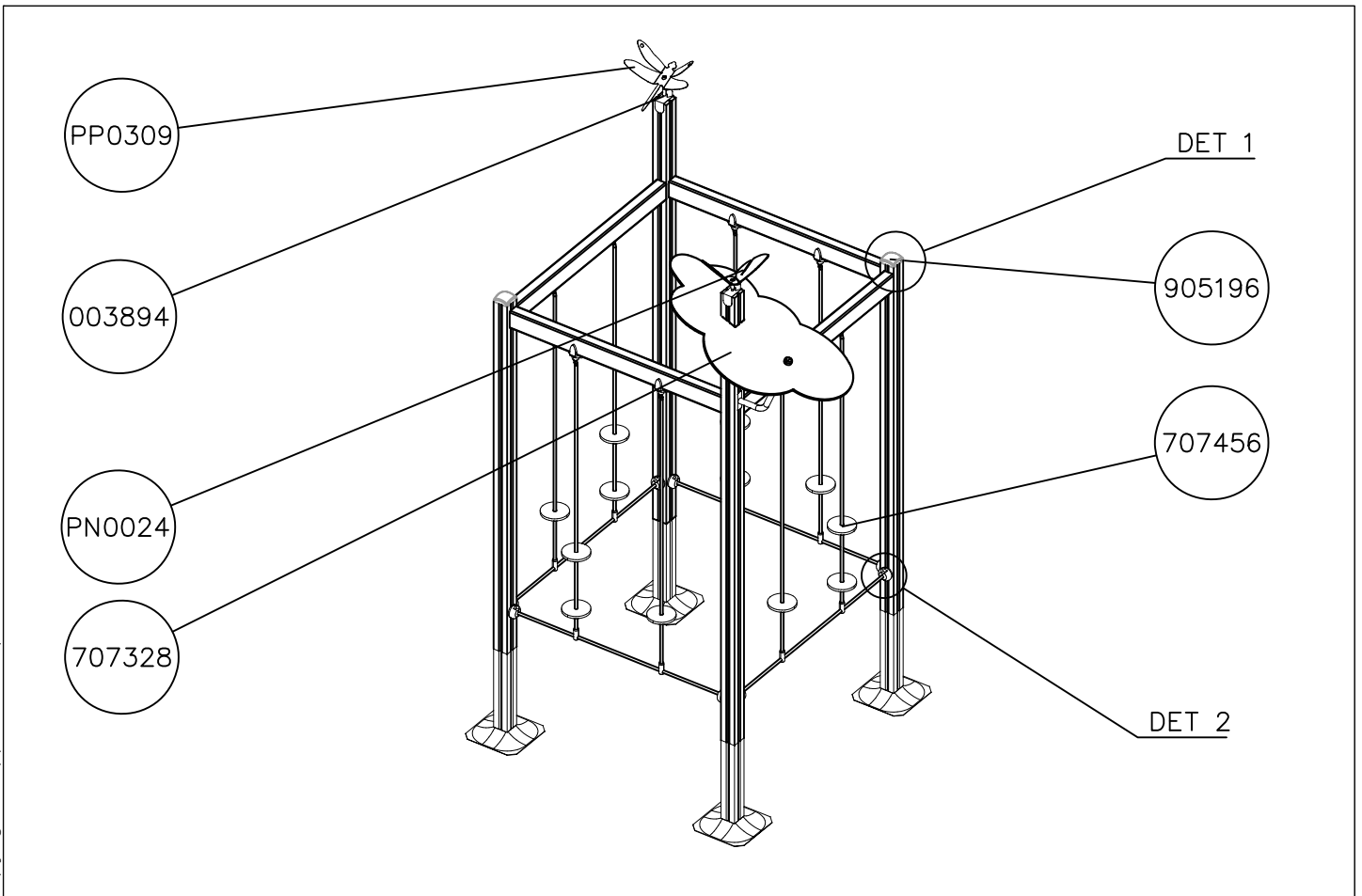
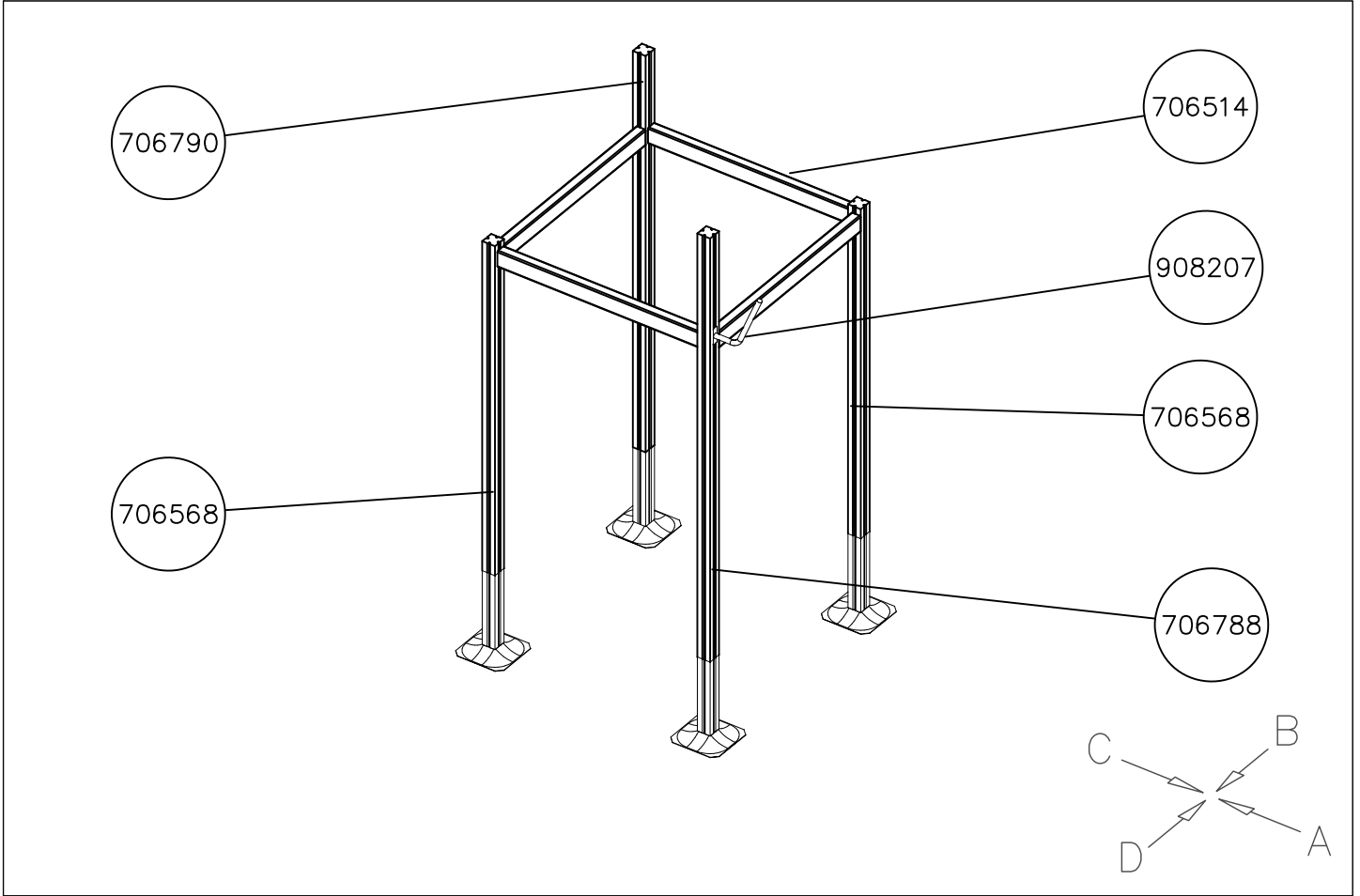

DATE: 27.4.2021

1:50

A

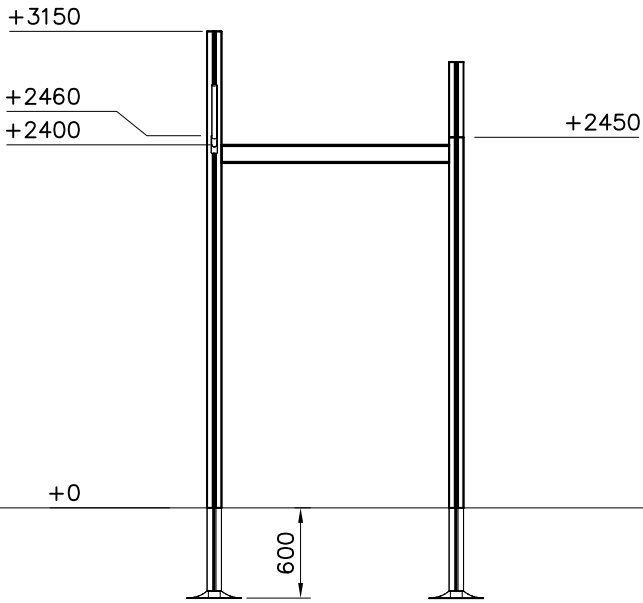

B

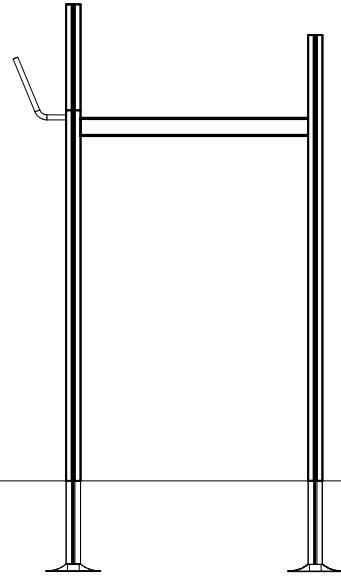

C

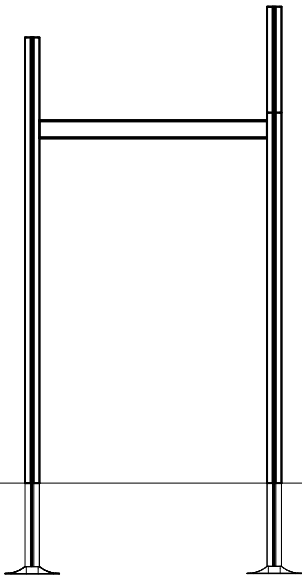

D

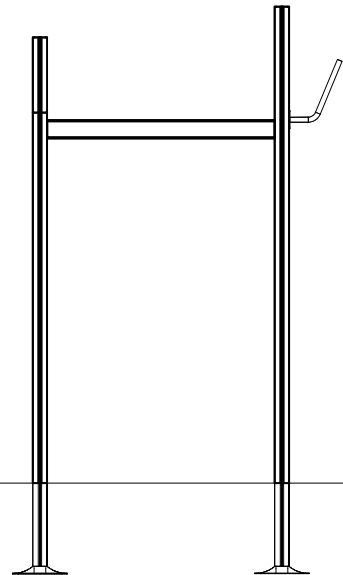

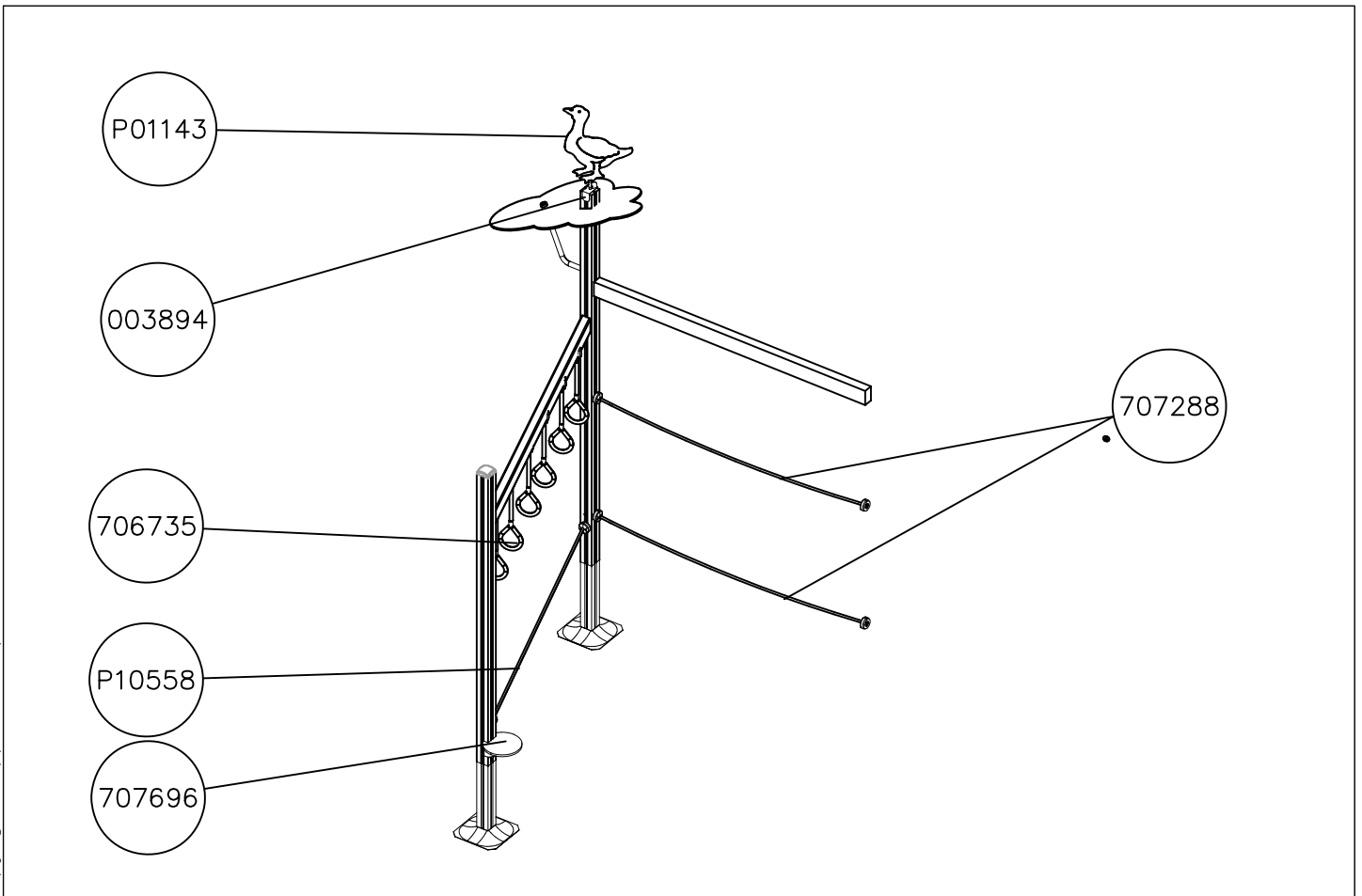
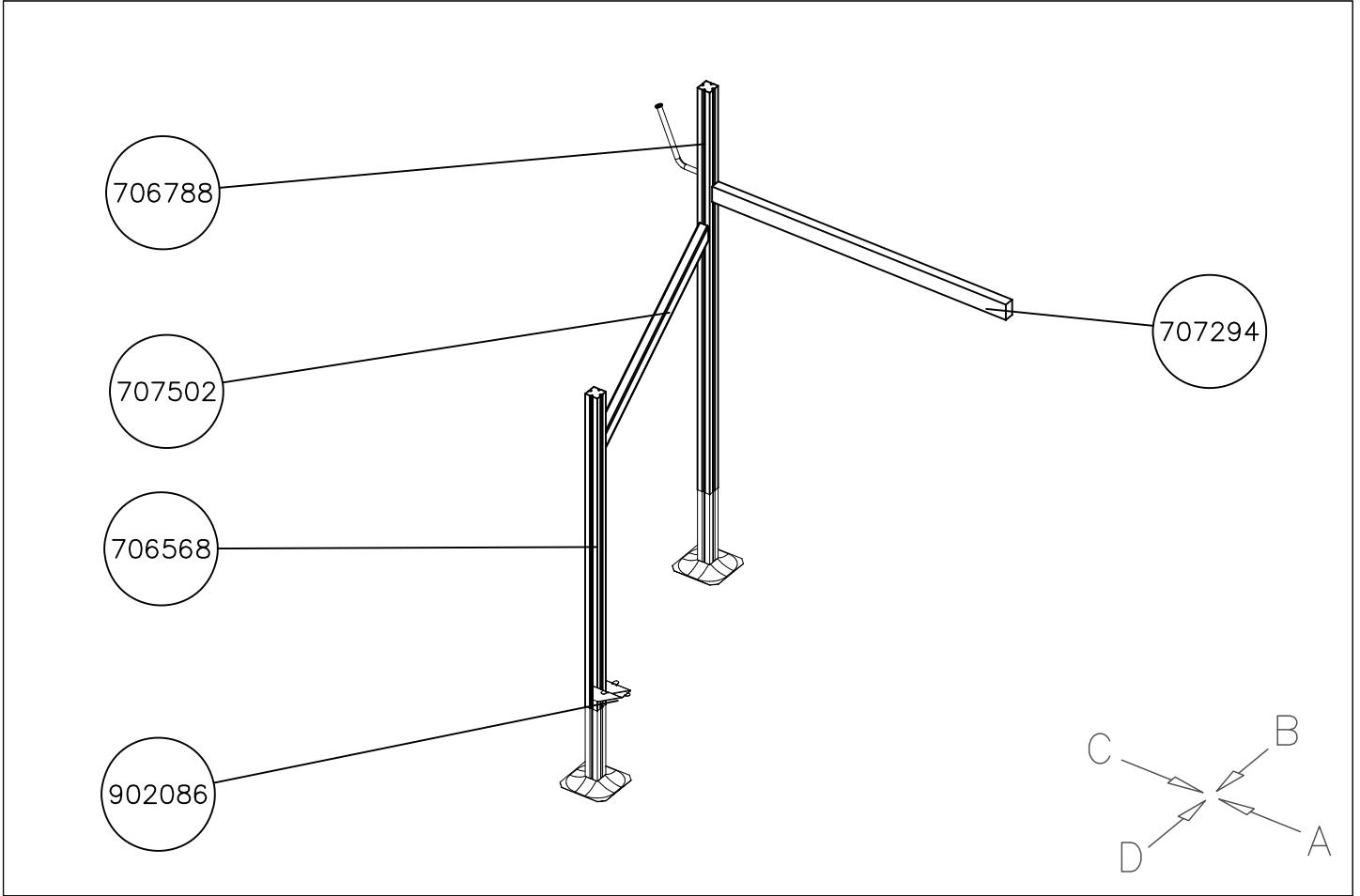

1:50

(B)

(A)

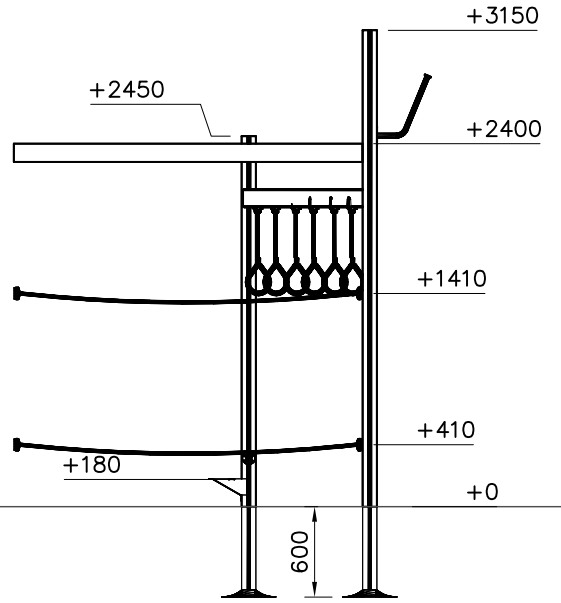
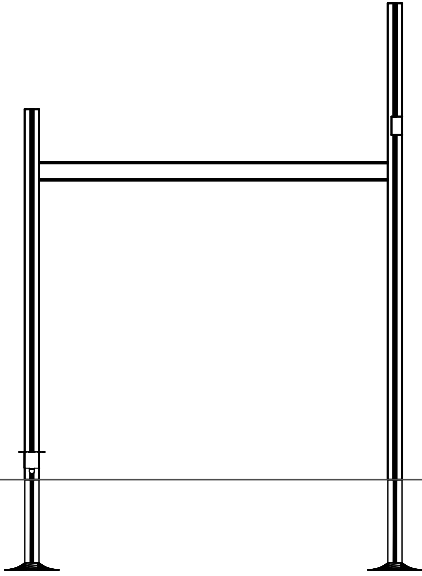

(C)

(D)

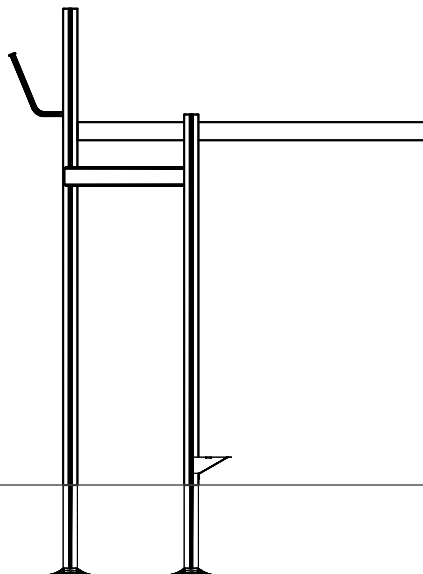
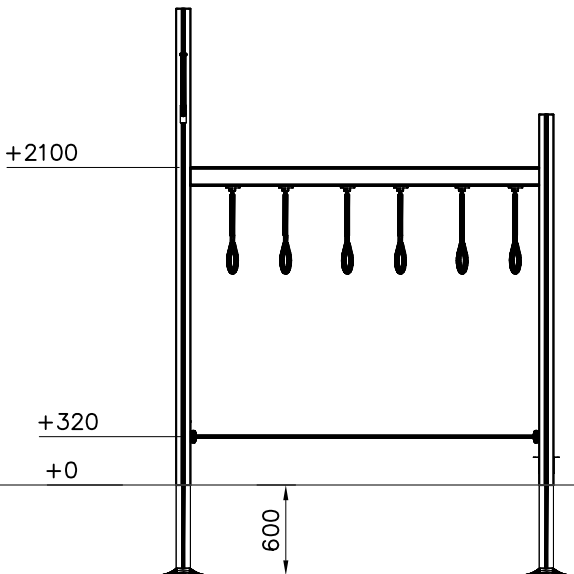

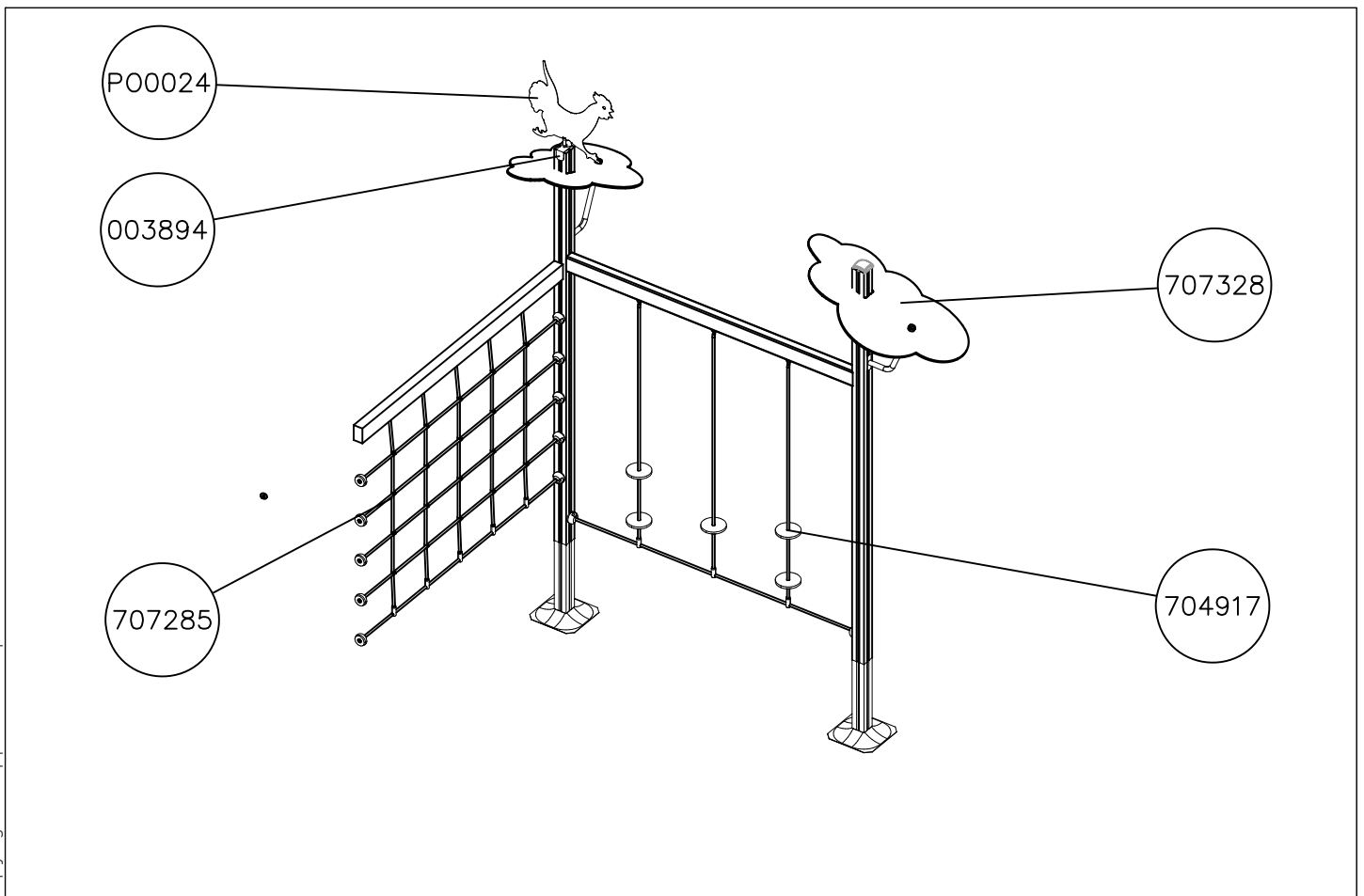
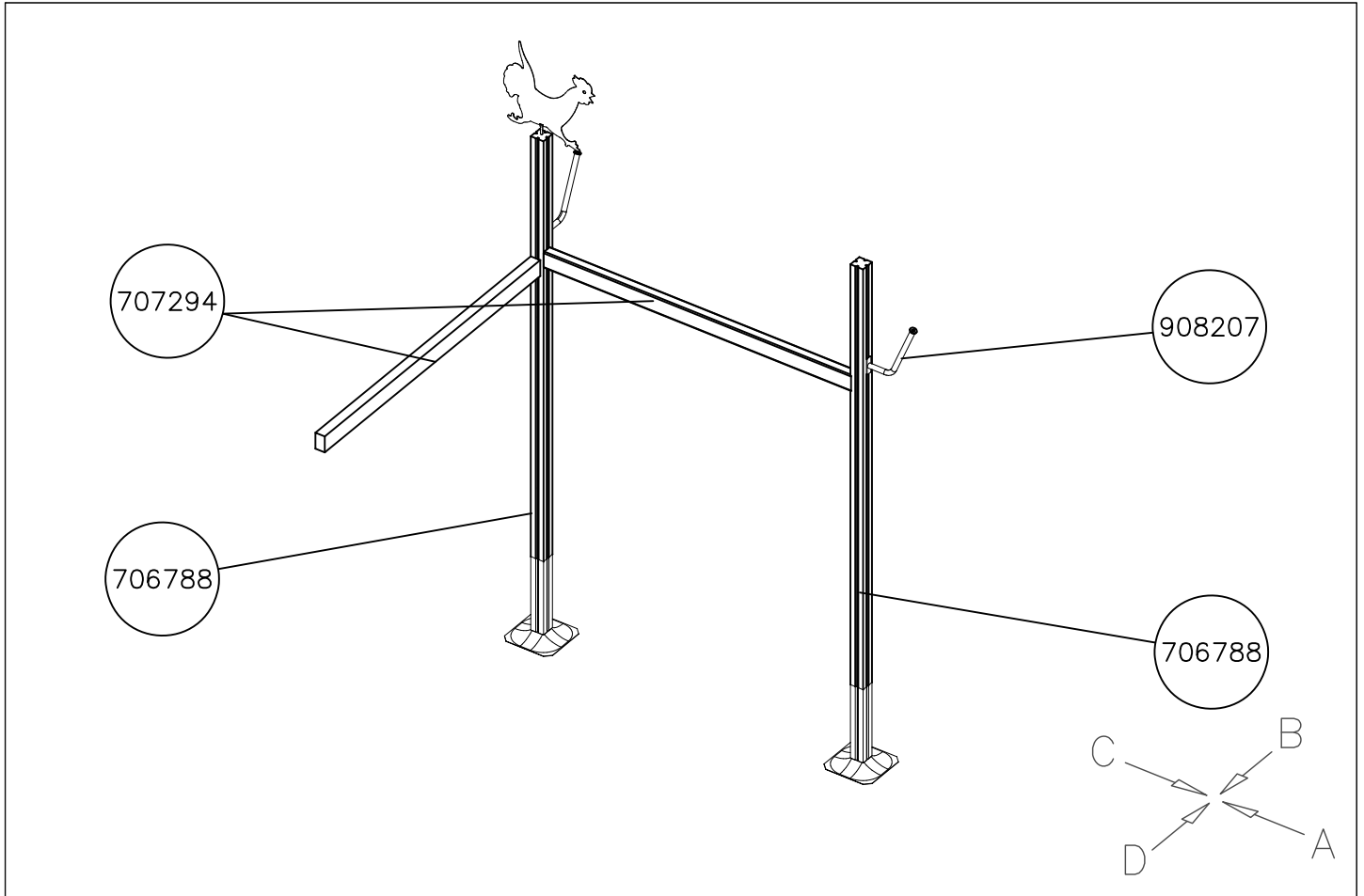

1:50

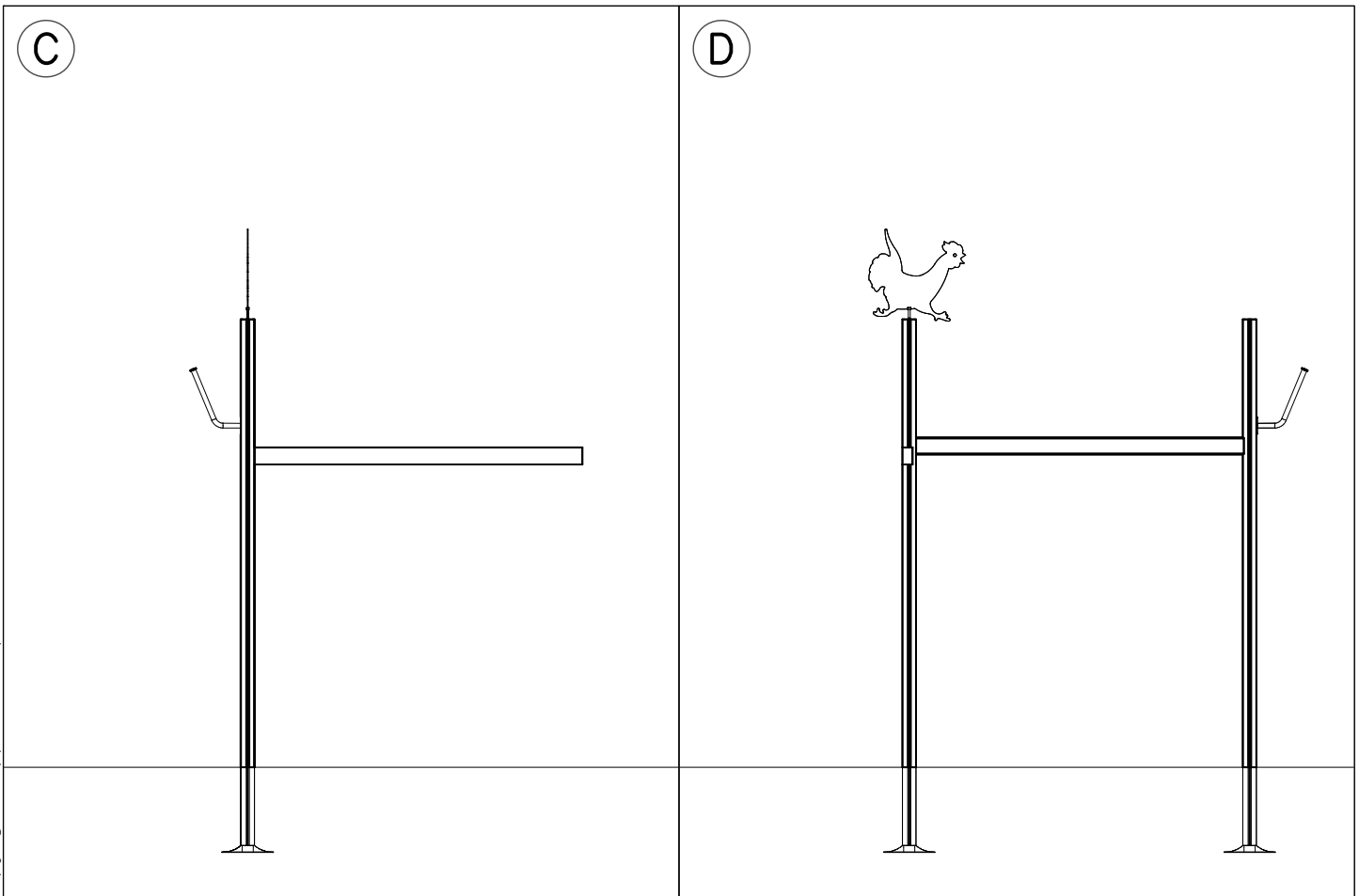
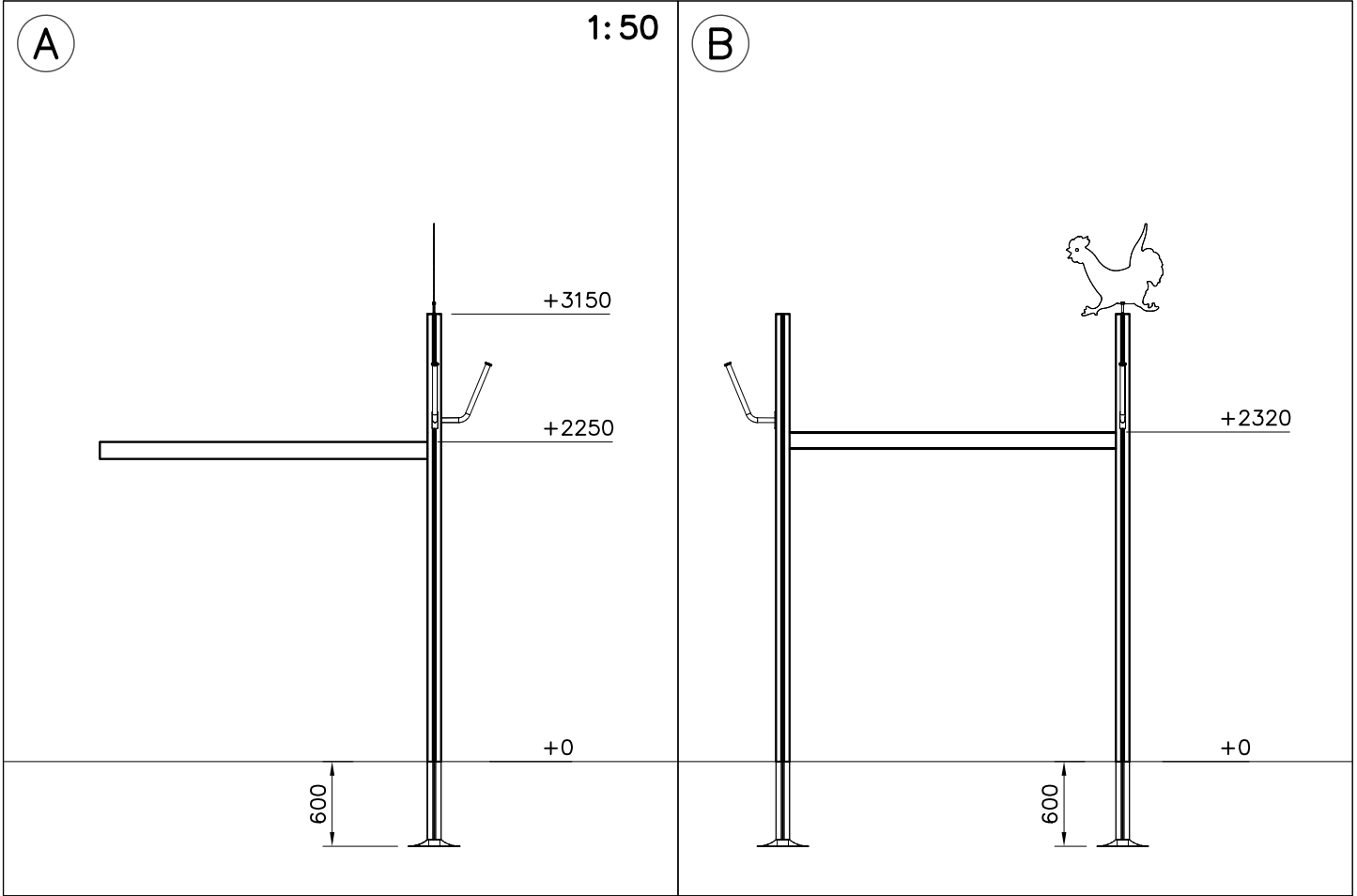

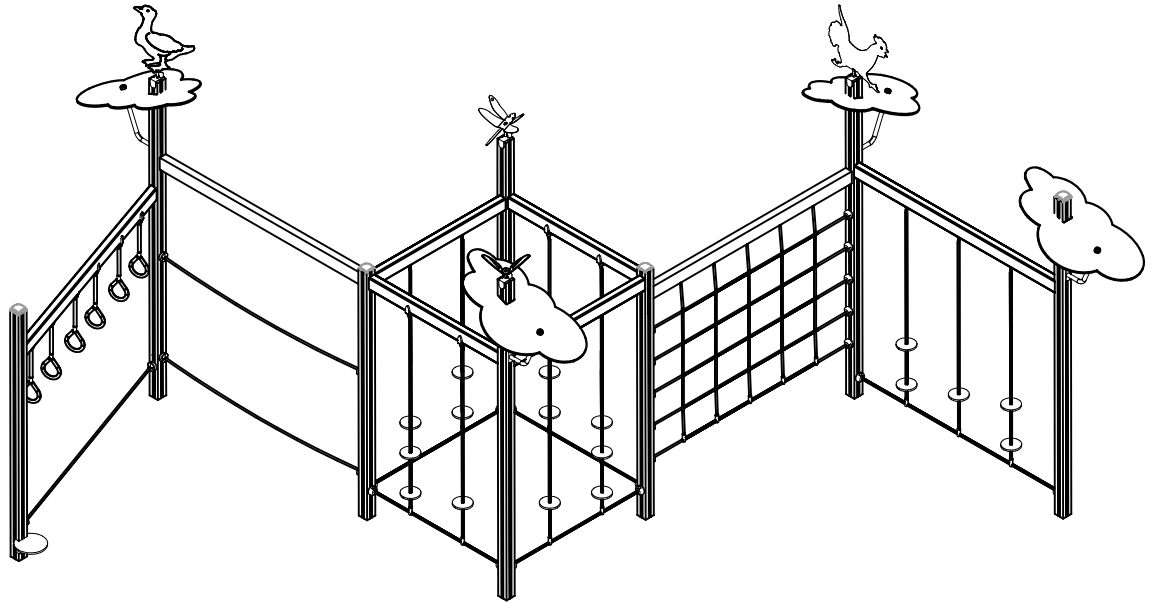

Max Falling Height

